

Operating Manual

Centrisart[®] G-16C

Refrigerated centrifuge from serial no. 157633



© Copyright by
Sartorius Lab Instruments GmbH & Co. KG
Weender Landstraße 94-108
37075 Göttingen
Germany

Phone: +49.551.308.0
Fax: +49.551.308.3289
www.sartorius.com

1	General information	9
1.1	Importance of the operating manual	9
1.2	Intended use.....	9
1.3	Warranty and liability	9
1.4	Copyright	10
1.5	Standards and regulations	10
1.6	Scope of supply.....	10
2	Layout and mode of operation.....	11
2.1	Layout of the centrifuge	11
2.1.1	Functional and operating elements	11
2.1.2	Name plate	12
2.2	Mode of operation	13
2.2.1	Centrifugation principle	13
2.2.2	Area of application.....	13
2.2.2.1	Speed, radius, and relative centrifugal force	14
2.2.2.2	Density.....	14
3	Safety.....	15
3.1	Marking of the unit	15
3.2	Explanation of the symbols and notes	16
3.3	Responsibility of the operator	17
3.4	Operating personnel	17
3.5	Informal safety instructions	17
3.6	Safety instructions	18
3.6.1	Electrical safety	18
3.6.2	Mechanical safety.....	18
3.6.3	Fire prevention	19
3.6.4	Chemical and biological safety.....	19
3.6.5	Safety instructions for centrifugation	20
3.6.6	Resistance of plastics.....	20
3.6.7	Service life of rotors and accessories.....	20
3.7	Safety devices.....	21
3.7.1	Lid lock device	21
3.7.2	Standstill monitoring system	21
3.7.3	System check.....	21
3.7.4	Earth conductor check.....	21
3.7.5	Imbalance monitoring system.....	21
3.7.6	Temperature monitoring system	21
3.7.7	Rotor monitoring system.....	21
3.8	Measures in the event of hazards and accidents	22
3.9	Remaining hazards	22

4	Storage and transport	23
4.1	Dimensions and weight.....	23
4.2	Storage conditions.....	23
4.3	Notes on transport.....	23
4.4	Packaging.....	24
4.5	Transport safety device.....	24
5	Set-up and connection	25
5.1	Installation site.....	25
5.2	Power supply.....	25
5.2.1	Type of connection.....	25
5.2.2	Customer-provided fuses.....	25
6	Using the centrifuge	26
6.1	Initial start-up.....	26
6.2	Switching the centrifuge on.....	26
6.2.1	Opening and closing the lid.....	26
6.2.2	Installation of rotors and accessories.....	27
6.2.2.1	Installation of the rotor.....	27
6.2.2.2	Installation of angle rotors with a hermetically sealed lid.....	27
6.2.2.3	Installation of accessories.....	28
6.2.2.4	Adapters.....	29
6.2.2.5	Tubes.....	29
6.3	Control system "Spincontrol L".....	30
6.3.1	User interface.....	30
6.3.2	Manual mode.....	31
6.3.2.1	Starting a centrifugation run.....	31
6.3.2.2	Interrupting a centrifugation run.....	31
6.3.2.3	Interrupting a deceleration process.....	31
6.3.2.4	Selection, display, and modification of data.....	31
6.3.2.1	Speed / relative centrifugal force (RCF).....	32
6.3.2.2	Runtime.....	32
6.3.2.3	Temperature.....	34
6.3.2.4	Rotor selection.....	36
6.3.2.5	Acceleration and deceleration curves.....	37
6.3.2.6	Automatic lid opening function ("AutoOpen").....	37
6.3.2.7	Sound signal ("Buzzer").....	38
6.3.2.8	Program lock ("ProgLock").....	38
6.3.2.9	Cycle display ("Cycles").....	39
6.3.2.10	Input lock.....	40
6.3.3	Program mode.....	40
6.3.3.1	Saving a program.....	41
6.3.3.2	Loading a program.....	41
6.4	Switching the centrifuge off.....	42

7	Malfunctions and error correction	43
7.1	General malfunctions.....	43
7.1.1	Emergency lid release.....	44
7.2	Table of error codes.....	45
7.3	Service contact.....	46
8	Maintenance and service	47
8.1	Maintenance.....	47
8.1.1	Centrifuge.....	47
8.1.1.1	Condenser (only refrigerated centrifuges).....	48
8.1.2	Accessories.....	48
8.1.2.1	Plastic accessories.....	49
8.1.3	Rotors, buckets and carriers.....	49
8.1.4	Load bearing bolts.....	49
8.1.5	Glass breakage.....	50
8.2	Sterilisation and disinfection of the rotor chamber and accessories.....	50
8.2.1	Autoclaving.....	51
8.3	Service.....	52
8.4	Return of defective units.....	53
9	Disposal	54
10	Technical data	55
10.1	Ambient conditions.....	56
11	Appendix	57
11.1	Range of accessories.....	57
11.1.1	Maximum speed for tubes.....	58
11.1.2	Rotor radii.....	58
11.2	Speed-gravitational-field-diagram.....	59
11.3	Acceleration and deceleration curves.....	60
11.4	Resistance data.....	63
11.5	EC declaration of conformity.....	67
12	Index	69

1 General information

1.1 Importance of the operating manual

A fundamental requirement for the safe and trouble-free operation of the centrifuge is to be familiar with the fundamental safety instructions and all possible hazards.

The operating manual includes important information concerning the safe operation of the centrifuge.

This operating manual and, in particular, the notes on safety and hazards must be observed by all persons operating the centrifuge.

In addition, the local rules and regulations for the prevention of accidents must be complied with.

1.2 Intended use

Centrifuges are power-driven machines that separate liquids from solid matter, liquid mixtures, or solid mixtures by centrifugal force. They are solely intended for this purpose. Any other use beyond this area of application is regarded as improper use. Sartorius Lab Instruments GmbH & Co. KG cannot be held liable for any damage resulting from such improper use.

The intended use also includes

- observation of all the notes and instructions included in the operating manual and
- compliance with the care, cleaning, and maintenance instructions.

1.3 Warranty and liability

The warranty and liability are subject to our "General Terms and Conditions of Business Relating to Goods and Services of Sartorius" that were distributed to the operator upon the conclusion of the contract.

Warranty and liability claims are excluded if they are due to:

- improper use.
- non-compliance with the safety instructions and hazard warnings in the operating manual.
- improper installation, start-up, operation, or maintenance of the centrifuge.

1.4 Copyright

The information and figures contained in these instructions correspond to the version date specified below.

Sartorius reserves the right to make changes to the technology, features, specifications and design of the equipment without notice.

Copyright notice:

This operating manual, including all of its components, is protected by copyright. Any use beyond the limits of the copyright law is not permitted without our approval.

This applies in particular to reprinting, translation and edition irrespective of the type of media used.

1.5 Standards and regulations

EC declaration of conformity
(see chapter 11.5 - "EC declaration of conformity")

1.6 Scope of supply

The centrifuge comprises:

- 1 connection cable depending on the voltage variant
- 1 box spanner, size 10 Part no. 69CE0009
(rotor fastening)
- 1 tube of grease for load bearing bolts Part no. 69CE0006
- 1 bottle of slushing oil Part no. 69CE0003

Documentation:

Operating manual incl. EC declaration of conformity
(see chapter 11.5 - "EC declaration of conformity").

Accessories

According to your order, our order confirmation, and your delivery note.

2 Layout and mode of operation

2.1 Layout of the centrifuge

2.1.1 Functional and operating elements

- 1 Lid
- 2 User interface (see chapter 6.3.1 - "User interface")
- 3 Mains switch



Fig. 1: Total view of the centrifuge

- 4 Name plate (see chapter 2.1.2 - "Name plate")
- 5 Mains power input
- 6 Equipotential bonding screw



Fig. 2: Rear view of the centrifuge

2.1.2 Name plate

- 1 Manufacturer and registered office
- 2 Type
- 3 Serial number
- 4 Refrigerant data
- 5 Max. density
- 6 Nominal voltage
- 7 Input fuse
- 8 Symbol for special disposal (see chapter 9 - "Disposal")
- 9 CE mark in compliance with the directive 2006/42/EC
- 10 Part number
- 11 Year of manufacture
- 12 Max. speed
- 13 Max. kinetic energy
- 14 Power consumption



Fig. 3: Example of a name plate

2.2 Mode of operation

2.2.1 Centrifugation principle

Centrifugation is a process for the separation of heterogeneous mixtures of substances (suspensions, emulsions, or gas mixtures) into their components. The mixture of substances, which rotates on a circular path, is subject to centripetal acceleration that is several times greater than the gravitational acceleration.

Centrifuges use the mass inertia inside the rotor chamber for separating the substances. Due to their higher inertia, particles or media with a higher density travel outwards. In doing so, they displace the components with a lower density, which in turn travel towards the centre.

The centripetal acceleration of an object inside a centrifuge, as the effect of centripetal force, depends on the distance between the object and the axis of rotation as well as on the angular velocity. It increases linearly as a function of the distance with regard to the axis of rotation and quadratically as a function of the angular velocity. The bigger the radius in the rotor chamber is and the higher the speed is, the higher the centripetal acceleration is. However, the forces acting on the rotor also increase.

2.2.2 Area of application

Depending on the area of application of the centrifuge and also on the particle size, solids content, and volume throughput of the mixture of substances that is to be centrifuged, there are different types of centrifuges.

The areas of application go from household use as a salad spinner or honey separator up to specialised technical applications in the clinical, biological, or biochemical context:

- For numerous clinical examinations, cellular material must be separated from the liquid to be analysed. The normal separation process can be sped up considerably by using laboratory centrifuges.
- In the metal-working industry, centrifuges are used for separating oil from metal cuttings. Dairies use centrifuges in order to separate cow's milk into cream and low-fat milk.
- Particularly big centrifuges are used in the sugar industry for separating the syrup from the crystalline sugar.
- Ultracentrifuges are predominantly used in biology and biochemistry in order to isolate particles, e.g. viruses. They are specifically designed for high speeds up to 500,000 rpm. The rotor moves in a vacuum in order to avoid air friction.

2.2.2.1 Speed, radius, and relative centrifugal force

The acceleration g , which the samples are subject to, can be increased by increasing the radius in the rotor chamber and by increasing the speed. These three parameters are interdependent and linked with each other via the following formula:

$$\text{Relative centrifugal force } RCF = 11.18 \times 10^{-6} \times r \times n^2$$

r = radius in cm

n = speed in rpm

RCF without any dimension

If two values are entered, the third value is determined by way of the stated formula. If, afterwards, the speed or the radius is changed, the resulting relative centrifugal force will be recalculated automatically by the control unit. If the RCF is changed, the speed will be adapted while the specified radius is maintained.

The speed-gravitational-field-diagram provides an overview of the relationship between speed, radius, and RCF (see chapter 11.2 - "Speed-gravitational-field-diagram").

2.2.2.2 Density

The laboratory centrifuge is suitable for the separation of constituents of different densities in mixtures with a maximum density of 1.2 g/cm³. All information concerning the speed of rotors and accessories refers to liquids with a density corresponding to this specification. If the density is above this value, the maximum permissible speed of the centrifuge must be reduced based on the following formula:

$$n = n_{max} \times \sqrt{(1,2 / Rho)}$$

Rho = density in g/cm³

3 Safety

3.1 Marking of the unit

The following symbols are used for all types of centrifuges manufactured by Sartorius:

	Dangerous voltage		On (Power)
	Hot surface		Off (Power)
	Caution! Risk of bruising		Name plate (see chapter 2.1.2 - "Name plate")
	Protective earth (ground)		CE mark in compliance with the directive 2006/42/EC
	Earth (ground)		Do not dispose as part of domestic waste
	Unplug the mains plug		GS mark (tested safety; only for Germany)
	Arrow indicating the direction of rotation		NRTL mark (only for the USA and Canada)
	Label concerning the FCC rules (only for Canada)		RCM mark (only for Australia)
			China RoHS 2 mark (only for China)



Safety indications on the centrifuge must be kept readable at all times. If necessary, they must be replaced.



Not all of the symbols/labels are used for this centrifuge type.

3.2 Explanation of the symbols and notes

In this operating manual, the following names and symbols to indicate hazards are used:



This symbol stands for a **direct** hazard to the life and health of persons.

Non-observance of these symbols **causes** serious health problems up to life-endangering injuries.



This symbol stands for a **direct** hazard to the life and health of persons due to electrical voltage.

Non-observance of these symbols **causes** serious health problems up to life-endangering injuries.



This symbol stands for a **potential** hazard to the life and health of persons.

Non-observance of these symbols **can** cause serious health problems up to life-endangering injuries.



This symbol indicates a potentially hazardous situation

Non-observance of these notes can cause minor injuries or damage to property.



This symbol indicates important information.

3.3 Responsibility of the operator

The operator undertakes to authorise only trained, specialised personnel to work on the centrifuge (see chapter 3.4 - "Operating personnel").

The areas of responsibility of the personnel concerning the operation, maintenance, and care of the unit must be clearly defined.

The safety-conscious work of the personnel in compliance with the operating manual and the relevant EC health and safety directives, and the national laws concerning health and safety and the prevention of accidents must be checked at regular intervals (e.g. every month).

Under the international rules for health and safety at work, the operator is obliged to:

- take measures in order to prevent danger to life or health during work.
- ensure that the centrifuges are used properly and entirely as intended (see chapter 1.2 - "Intended use").
- take protective measures against fire and explosion when working with hazardous substances.
- take measures for the safe opening of the centrifuges.

3.4 Operating personnel

Only trained, specialised personnel are authorised to operate the unit. The persons operating the unit must

- be familiar with the fundamental health, safety, and accident prevention regulations.
- have read and understood this operating manual, in particular the safety sections and warning notes, and confirmed this with their signature.

3.5 Informal safety instructions

- This operating manual is a part of the product.
- The operating manual must be kept at the location of use of the centrifuge. Ensure that it is accessible at all times.
- The operating manual must be handed over to any subsequent owner or operator of the centrifuge.
- Any changes made must be added to the operating manual.
- In addition to the operating manual, the general and local rules and regulations concerning the prevention of accidents and the protection of the environment must also be supplied.
- Safety and danger indications on the centrifuge must be kept readable at all times. If necessary, they must be replaced.

3.6 Safety instructions

3.6.1 Electrical safety

To reduce the risk of electrical shock, the centrifuge uses a three-wire electrical cord and plug to connect the equipment to earth-ground. To preserve this safety feature:



DANGER

- Ensure that the wall socket is properly wired and grounded.
- Check that the mains voltage agrees with the nominal voltage listed on the name plate.
- Do not place vessels containing liquid on the centrifuge lid or within the safety distance of 30 cm around the centrifuge. Spilled liquids may get into the centrifuge and damage electrical or mechanical components.
- Work on the power supply system must only be performed by certified electricians.
- Inspect the electrical equipment of the unit regularly. Defects such as loose or burnt cables must be eliminated immediately.

3.6.2 Mechanical safety

In order to ensure the safe operation of the centrifuge, observe the following:



WARNING

- Do not open the lid when the rotor is in motion!
- Do not reach into the rotor chamber when the rotor is in motion!
- Do not use the centrifuge if it was installed incorrectly.
- Do not use the centrifuge without panels.
- Do not use the centrifuge if the rotors and inserts show signs of corrosion or other defects.
- Only use the centrifuge with rotors and accessories that have been approved by the manufacturer. In case of doubt, contact the manufacturer (see chapter 7.3 - "Service contact").
- Do not hold your fingers between the lid and the housing when closing the lid. Risk of crushing!
- Defective lid relieving devices could cause the centrifuge lid to fall (contact the service department, if necessary). Risk of crushing!
- Do not hit or move the centrifuge during its operation.
- Do not lean against or rest on the centrifuge during its operation.
- Do not spin any substances that could damage the material of the rotors and buckets of the centrifuge in any way. Highly corrosive substances, for example, damage the material and affect the mechanical strength of the rotors and buckets.
- Stop the centrifuge immediately in the event of a malfunction. Eliminate the malfunction (see chapter 7 - "Malfunctions and error correction") or inform the service department of the manufacturer (see chapter 7.3 - "Service contact").
- Ensure that all repairs are performed only by authorised and specialised personnel.

**WARNING**

- Prior to any start-up, check the centrifuge, rotor, and accessories for signs of damage that can be discerned from the outside. Special attention must be paid to all of the rubber parts (e.g. motor cover, lid seal, and adapters) in terms of visible structural changes. Defective parts must be replaced immediately.
- Open the centrifuge when it is not in use so that moisture can evaporate.

3.6.3 Fire prevention

**DANGER**

- Do not spin explosive or inflammable substances.
- Do not use the centrifuge within hazardous locations.

3.6.4 Chemical and biological safety

If pathogenic, toxic, or radioactive samples are intended to be used in the centrifuge, it is in the responsibility of the user to ensure that all necessary safety regulations, guidelines, precautions, and practices are adhered to accordingly.

**DANGER**

- Infectious, toxic, pathogenic, and radioactive substances may only be used in special, certified containment systems with a bio-seal in order to prevent the material from being released.
- Take suitable precautions for your own safety if there is a risk of toxic, radioactive, or pathogenic contamination
- Materials that chemically react with each other with a high level of energy are prohibited.

**WARNING**

- Keep informed about local measures to avoid harmful emissions (depending on the substances to be centrifuged).
- Protective clothing is not required for the operation of the centrifuge. The materials to be centrifuged may, however, require special safety measures (e.g. centrifugation of infectious, toxic, radioactive, or pathogenic substances).

3.6.5 Safety instructions for centrifugation

For safe operation, observe the following before starting the centrifuge:



WARNING

- Ensure that the centrifuge was set up properly (see chapter 5 - "Set-up and connection").
- Maintain a safety distance of at least 30 cm (12 inches) around the centrifuge.
- Do not store any dangerous goods in the centrifuge area.
- Do not stay in the safety area longer than what is absolutely necessary for the operation of the centrifuge.
- Only use the centrifuge with rotors and accessories that have been approved by the manufacturer. We explicitly warn against the use of equipment of poor quality. Breaking glass or bursting vessels can cause dangerous imbalances at high speeds
- Ensure that rotor and buckets are correctly fitted (see chapter 6.2.2.1 - "Installation of the rotor").
- Observe the instructions on the installation of accessories (see chapter 6.2.2.3 - "Installation of accessories").
- The rotor must be loaded axial symmetrically at equal weights.
- If liquids with a density $> 1.2 \text{ g/cm}^3$ are used, reduce the speed (see chapter 2.2.2.2 - "Density").
- Do not use the centrifuge if the rotor is loaded asymmetrically.
- Do not use the centrifuge with tubes that are excessively long.



WARNING

3.6.6 Resistance of plastics

Chemical influences have a strong effect on the polymeric chains of plastics, and, therefore, on their physical properties. Plastic parts can be damaged if solvents, acids, or alkaline solutions are used.



NOTE

- Refer to the resistance data (see chapter 11.4 - "Resistance data")!

3.6.7 Service life of rotors and accessories

The rotors and accessories have a limited service life.



WARNING

- Perform regular checks (at least once per month) for safety reasons!
- Pay special attention to changes, such as corrosion, cracks, material abrasion, etc.
- After 10 years, they must be inspected by the manufacturer.
- After 50,000 cycles, the rotor must be scrapped for reasons of safety.
- If other data concerning the service life are engraved on the rotor or bucket, these data shall apply accordingly. For example, a bucket with the engraving "max. cycles = 10,000" has a service life of 10,000 cycles, and a rotor with the engraving "Exp. date 02/20" must be scrapped in February 2020 at the latest.

3.7 Safety devices

3.7.1 Lid lock device

The centrifuge can only be started when the lid is properly closed. The electrical lock must be locked. The lid can only be opened when the rotor has stopped. If the lid is opened by way of the emergency release system during operation, the centrifuge will immediately switch off and decelerate brakeless. If the lid is open, the drive is completely separated from the mains power supply, i.e. the centrifuge cannot be started (see chapter 7.1.1 - "Emergency lid release").

3.7.2 Standstill monitoring system

Opening of the centrifuge lid is only possible if the rotor is at a standstill. This standstill is checked by the microprocessor.

3.7.3 System check

An internal system check monitors the data transfer and sensor signals with regard to plausibility. The system continuously performs a self-check and identifies malfunctions. Error messages are displayed as "Error" followed by a code number (see chapter 7.2 - "Table of error codes").

3.7.4 Earth conductor check

For the earth conductor check, there is an equipotential bonding screw on the rear panel of the centrifuge (see chapter 2.1.1 - "Functional and operating elements"). An earth conductor check can be carried out by authorized and specialized personnel using a suitable measuring instrument. Please contact the service department (see chapter 7.3 - "Service contact").

3.7.5 Imbalance monitoring system

The indication "Imbalance" in the rotor field and, in some cases, also a sound signal indicate that the centrifuge is in the impermissible imbalance range. The drive will be switched off in the acceleration phase or during the run.

3.7.6 Temperature monitoring system

If the temperature inside the rotor chamber rises above 50°C, the drive system will be switched off automatically. The centrifuge cannot be restarted until it has cooled.

3.7.7 Rotor monitoring system

When a rotor number is selected, the computer will automatically check whether the entered speed or the entered gravitational field are permissible for the selected rotor.

3.8 Measures in the event of hazards and accidents



DANGER

- If an emergency arises, switch off the centrifuge immediately!
- If in doubt, call the emergency doctor!

3.9 Remaining hazards

The unit was built state- of- the- art and according to the accepted safety rules. However, danger to life and limb of the operator, or of third parties, or impairments of the unit or other material assets cannot be completely excluded when the unit is being used.

- Use the unit only for the purpose that it was originally intended for (see chapter 1.2 - "Intended use").
- Use the unit only if it is in a perfect running state.
- Immediately eliminate any problems that can affect safety.

4 Storage and transport

4.1 Dimensions and weight

	Centrisart® G-16C
Height:	355 mm
Height with open lid:	785 mm
Width:	630 mm
Depth:	600 mm
Weight:	78 kg

4.2 Storage conditions

The centrifuge can be stored in its original packaging for up to a year.

- Store the centrifuge only in dry rooms.
- The permissible storage temperature is between -20°C and +60°C.
- If you would like to store it for more than one year, or if you intend to ship it overseas, please contact the manufacturer.

4.3 Notes on transport

- Install the transport safety device (see chapter 4.5 - "Transport safety device")
- Always lift the centrifuge with a lifting device or with a sufficient number of people helping you.
- When lifting the centrifuge, always reach under the centrifuge from the side.



CAUTION

The centrifuge weighs approx. 78 kg!

- For transport use suitable packaging and, if at all possible, the original packaging (see chapter 4.4 - "Packaging").

4.4 Packaging

The centrifuge is packaged in a slip-lid box.

- Take off the lid.
- Remove the box containing the accessories and the packaging material.
- Remove the slip-lid box.
- Lift the centrifuge upwards with a lifting device or with a sufficient number of people to lift it safely. When lifting the centrifuge, always reach under the centrifuge from the side.



CAUTION

The centrifuge weighs approx. 78 kg!

- Retain the packaging for any possible future transport of the centrifuge.

4.5 Transport safety device

The transport safety device consists of a foamed plastic piece in the rotor chamber.



CAUTION

The transport safety device must be removed prior to start-up because the screws lock the motor bearings!

Removal

- Open the lid by pressing the lid key. If the centrifuge is not connected to the power supply, use the emergency release of the lid (see chapter 7.1.1 - "Emergency lid release").
- Remove the foamed plastic piece (see figure, item 1) from the rotor chamber, by lifting it carefully on one side.

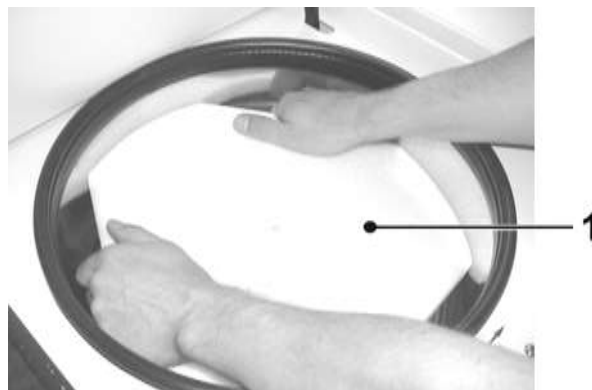

Fig. 4: Removal of the transport safety device

- Retain the transport safety device for the possibility of the return of the centrifuge.

5 Set-up and connection

5.1 Installation site

Operate the centrifuge only in closed and dry rooms.

All the energy supplied to the centrifuge is converted into heat and emitted to the ambient air.

- Ensure sufficient ventilation.
- Keep a safety distance of at least 30 cm around the centrifuge so that the vents in the centrifuge remain fully effective.
- Do not subject the centrifuge to thermal stress, e.g. by positioning it near heat generators.
- Avoid direct sunlight (UV radiation).
- The table must be stable and have a solid, even surface.
- Attention: During transport from cold to warmer places, condensational water will collect inside the centrifuge. It is important to allow sufficient time for drying (min. 24 h) before the centrifuge can be used again.

5.2 Power supply

5.2.1 Type of connection



DANGER

The operating voltage on the name plate must correspond to the local supply voltage!

Sartorius centrifuges are units of protection class I. The centrifuges of this model series have a three-wire power cord with an IEC C13 connector. They are equipped with a mains power switch with an integrated thermal circuit breaker.

- Switch the unit off by actuating the mains power switch.
- If it has tripped, let the circuit breaker cool for approximately 2 minutes.
- Switch the unit on.

The centrifuge is now ready for operation.

5.2.2 Customer-provided fuses

Typically, the centrifuge must be protected with 16 Amp L or B fuses that are to be provided by the customer.

6 Using the centrifuge

6.1 Initial start-up



DANGER

- Before the initial start-up, please ensure that your centrifuge is properly set up and installed (see chapter 5 - "Set-up and connection").

6.2 Switching the centrifuge on

- Press the mains power switch.
The display then illuminates. The centrifuge is ready for operation.

6.2.1 Opening and closing the lid

The lid can be opened if the centrifuge is at a standstill and if the lid key is illuminated.

- Press the lid key in order to open the lid.
The centrifuge cannot be started if the lid is opened.
- To close, press with both hands slightly on the lid until the electrical lock is locked.



WARNING

Do not place your fingers between the lid and the housing when closing the lid.
Risk of crushing!

6.2.2 Installation of rotors and accessories

6.2.2.1 Installation of the rotor

- Open the centrifuge lid by pressing the lid key.
- Unscrew the rotor tie-down screw from the motor shaft (counter-clockwise).
- Lower the rotor with its central bore straight down onto the motor shaft.
- Tighten the rotor tie-down screw clockwise with the supplied rotor wrench with 7.5 Nm. In doing so, hold the rotor at its outer rim.



WARNING

Once a day or after 20 cycles, the rotor tie-down screw must be loosened by some turns, and the rotor must be lifted and fastened again. This ensures a proper connection between the rotor and the motor shaft.



CAUTION

When using rotors for microtiter plate formats:
Ensure that the plate holders are inserted together with the plates into the buckets.



NOTE

The lid screw serves for the fastening of the lid onto the rotor only, not for the fastening of the rotor onto the motor shaft.

- Follow the safety instructions and hazard warnings (see chapter 3 - "Safety")!

6.2.2.2 Installation of angle rotors with a hermetically sealed lid

- Screw the rotor cover onto the rotor and tighten it.
- Lower the rotor with the cover onto the motor shaft .
- Insert the rotor tie-down screw into the motor shaft. Tighten the rotor tie-down screw with 7.5 Nm using the supplied rotor wrench so that the spring washer assembly is compressed tightly.
- The rotor can also be used without a cover.
- The rotors can be installed or removed with a closed lid after loosening the rotor tie-down screw.
- Follow the safety instructions and hazard warnings (see chapter 3 - "Safety")!

- 1 Rotor tie down screw
- 2 Lid
- 3 Rotor

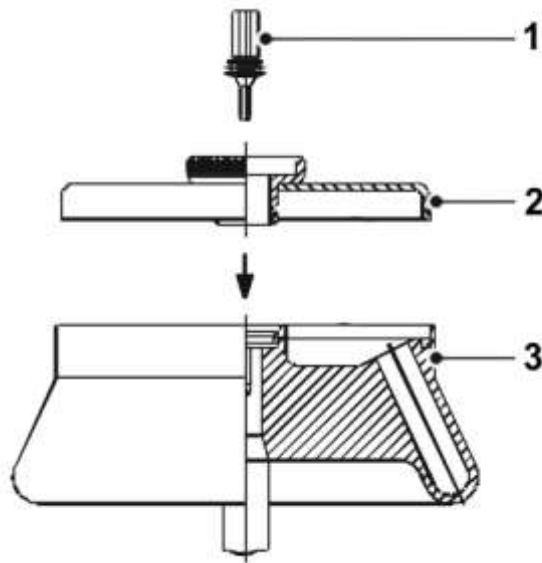

Fig. 5: Angle rotor with a hermetically sealed lid

6.2.2.3 Installation of accessories

- Only use inserts that are suitable for the rotor (see chapter 11.1 - "Range of accessories").
- All buckets of the swing-out rotor need to be installed when spinning.
- Always load the axial symmetrical inserts/buckets of the rotors with the same accessories and fill to avoid imbalance.

Centrifugation with different tube sizes

Working with different tube sizes is possible. In this case, however, it is very important that axial symmetrical inserts are identical.

correct

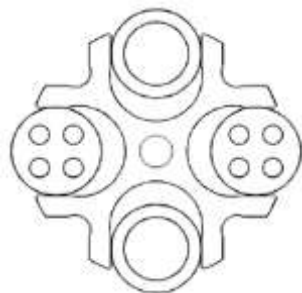

incorrect

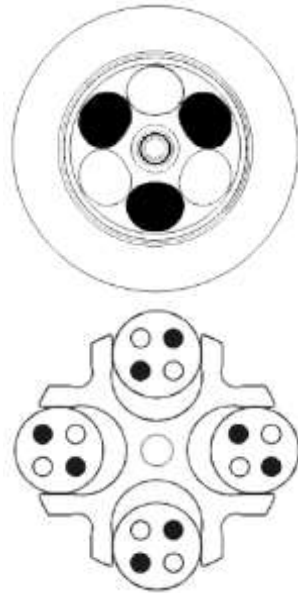

Fig. 6: Permissible and impermissible loading of a swing-out rotor with different tube sizes (example illustrations)

Centrifugation with low capacity

- Install the tubes axial symmetrically so that the buckets and their inserts are loaded evenly.
- It is not permissible to load angle rotors on only one axis.

correct



incorrect

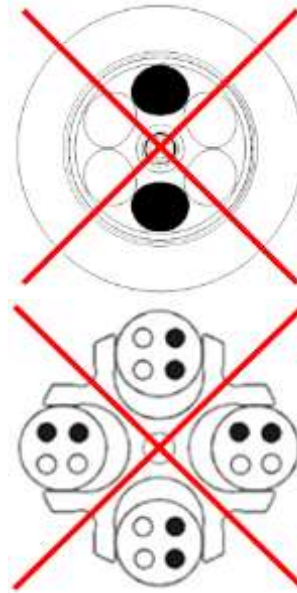

Fig. 7: Permissible and impermissible loading of an angle rotor and a swing-out rotor (example illustrations)

6.2.2.4 Adapters

In order to ensure easy handling, even if vessels of various sizes are used, carrier systems were developed.

- Load the opposite adapters with the same number of vessels and with the same weights in order to avoid imbalance.
- If all of the compartments of a carrier are not used, the buckets must be loaded evenly. Loading the edges of a bucket only is not permissible.

6.2.2.5 Tubes

- Load the tubes outside of the centrifuge. Liquids in the buckets or multiple carriers cause corrosion.
- Fill the tubes carefully and arrange them according to their weight. Imbalances result in the excessive wear of the bearings.
- In high-speed angle rotors, the vessels must be filled up to their useful volume (= the volume stated for the vessel). If the vessels are only partially filled, they will deform. This may result in leaks at the seals that may become loose.
- When using glass tubes, the maximum value of 4,000 x g must not be exceeded (except special high-strength glass tubes; please refer to the information provided by the manufacturer).
- Follow the safety instructions and hazard warnings (see chapter 3 - "Safety")!

6.3 Control system "Spincontrol L"

6.3.1 User interface

The centrifuge is operated via three buttons with integrated light-emitting diodes and one function knob. The display is divided into several different fields. The various functions of the system can be called up by pressing and turning the function knob.

- 1 Start key
- 2 Functional knob
- 3 Display
- 4 Stop key
- 5 Lid key



Fig. 8: User interface of the centrifuge

Display

The centrifuge display has the following display fields:

- 1 Speed/rcf field
- 2 Various display fields (e.g. for rotor, curve, or program selection)
- 3 Time field



Fig. 9: Display of the "Spincontrol L" control system

6.3.2 Manual mode

6.3.2.1 Starting a centrifugation run

The centrifuge is ready for operation when the start key is illuminated.

- Press the start key in order to start a centrifugation run.

6.3.2.2 Interrupting a centrifugation run

- Press the stop key in order to interrupt a centrifugation run. The centrifugation run will be terminated prematurely.

Quick stop

- Press the stop key for more than two seconds.

The centrifuge decelerates with the maximum deceleration curve.

After a quick stop, the centrifuge lid must be opened before a new centrifugation run can be started.

A quick stop can also be triggered during a normal deceleration, e.g. in order to speed up the deceleration.

When a quick stop is triggered, "fast" will be displayed in the lower right-hand corner of the display.

6.3.2.3 Interrupting a deceleration process

- Press the start key during a deceleration process in order to interrupt it and to restart the centrifuge.

6.3.2.4 Selection, display, and modification of data

- Turn the function knob in order to select a field. The selected field will be preceded by the indication "set", "run", or "save".
- Press the function knob. The indication ("set", "run", or "save") flashes and the modification mode is active.
- Turn the function knob in order to modify the set value of the selected field.
- Press the function knob again to confirm the input and to quit the modification mode
- The process will be interrupted if the stop key is pressed or after 60 seconds without any further input.

6.3.2.1 Speed / relative centrifugal force (RCF)

The set speed of the centrifuge is displayed in the upper area of the Speed/RCF field. The actual value is displayed right below. The speed is stated as the number of revolutions per minute ($\text{min}^{-1} = \text{rpm}$) and the RCF values as a multiple of the gravitational acceleration ($\times g$). The values are interdependent (see chapter 2.2.2.1 - "Speed, radius, and relative centrifugal force"). The maximum speed/RCF values depend on the rotor that is used.

The parameters speed and RCF can be changed during the centrifugation.



Fig. 10: Setting the speed value or the RCF value

6.3.2.2 Runtime

The set runtime is displayed in the upper section of this field, with the remaining runtime shown below. The runtime is counted down from the set value, starting with the start of the centrifuge and ending with the start of the deceleration phase. The maximum runtime is 99 h:59 min:59 sec. As of 59 min:59 sec, the unit switches from "h:min" to "min:s".

The parameter runtime can be changed during the centrifugation.

i
NOTE

If the runtime is changed during an active centrifugation run, the time that has already elapsed will not be taken into consideration. The centrifuge will perform a complete run with the new runtime.



Fig. 11: Setting the runtime, here in the time unit "min:s"

Runtime as of the set speed

If the runtime is to be counted as of the moment when the set speed is reached, the symbol (see the illustration) behind the set speed value must be activated:

- Select the clock symbol with the cursor and confirm the selection. The symbol and the bar under the symbol start to flash.
- Activate the function by turning the function knob. The symbol remains displayed in a permanent manner and the bar continues to flash.
- Further turning of the function knob will deactivate the function. In this case, the symbol disappears but the bar continues to flash.
- Press the function knob in order to activate the desired setting. The bar remains visible as long as the cursor is placed on the symbol.



Fig. 12: The function "Runtime as of the set speed" is activated

Continuous run

During the continuous run, the runtime of the centrifuge is unlimited and must be stopped manually. The centrifuge accelerates during the continuous run until the set speed is reached.

- Select the "Time" field and press the function knob. The indication "set" flashes in the activated status.
- Turn the function knob from the time 0:00:10 anti-clockwise or from the time 99:59:59 clockwise. The indication "Cont" will be displayed in the "Time" field. During the centrifugation run, the elapsed time will be displayed.
- Deactivate the continuous run by pressing the stop key or by entering a specific runtime.

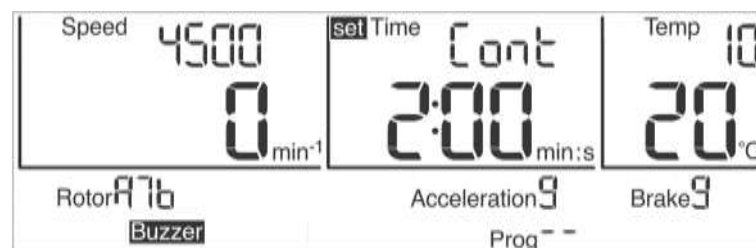

Fig. 13: Indication "Cont" during a continuous run

Short run

A short run can be started if no run is active.

- Keep the start key pressed during the short run.

During the short run, the centrifuge accelerates with the acceleration curve 9 (maximum) until the maximum permissible speed of the rotor is reached. The runtime is counted and in the "Time" field the indication "Short" is displayed.

When the start key is released, the centrifuge decelerates to a standstill based on the maximum deceleration curve.

When the short run is completed, the original parameters (curves, runtime, and final speed) are restored and displayed.



Fig. 14: Indication "Short" during a short run

6.3.2.3 Temperature

The set value is displayed in the upper area of the field and the actual sample temperature is displayed in the lower area. Temperatures between -10 °C and $+40\text{ °C}$ can be preselected.



NOTE

The centrifuge is not equipped with an active heater. This is why temperatures above room temperature depend on the air friction of the turning rotor.



fig. 15: Setting the temperature

Precooling

Depending on the substances to be centrifuged, it may make sense to precool the centrifuge. The precooling prevents the cooled samples in the uncooled centrifuge from heating up to an inadmissible temperature.



CAUTION

Unmoved air in the rotor chamber distorts the measuring and control behavior and causes the compressor to freeze over. At temperatures below 0 °C , aqueous liquids will freeze, making sedimentation impossible.

- Ensure that the rotor temperature will not fall below 0 °C when the rotor is at a standstill!

Program "Rapid Temp"

The centrifuge has a special "Rapid Temp" program that precools the centrifuge rapidly under defined conditions.

- Select the program with the aid of the menu item "run Prog" (see chapter 6.3.3.2 - "Loading a program"). The speed display shows $\frac{1}{6}$ of the maximum rotor speed, the deceleration (brake) and acceleration curves correspond to curve 9 and the runtime field indicates "Cont" (continuous run). "Rapid Temp" will flash next to the "run" display.



Fig. 16: "Rapid Temp" program



NOTE

The program will only be loaded if the actual temperature is above the set temperature.

- Press the start button in order to start the rapid cooling process.
- During the rapid cooling process, the set temperature can be modified within the range below the actual temperature.

The "Rapid Temp" program will be stopped under the following conditions:

- The set value is reached. The program will stop with a sound signal if this function is activated.
- The stop button is pressed. The program will be stopped prematurely.
- A parameter is changed (except for the temperature and rotors). In this case, the program will be aborted.

After the stop, the previous program will be reloaded or the changed parameters will be adopted as the new settings.



NOTE

The automatic lid opening function ("AutoOpen") is suppressed after a rapid cooling phase in order to prevent the system from reheating.



NOTE

If the "Rapid Temp" program is used, the temperature of the unloaded aluminium bucket will be displayed. If samples, which have not been pre-cooled, are placed into the buckets after a "Rapid Temp" run, the displayed temperature will deviate from the actual sample temperature.

6.3.2.4 Rotor selection

This field shows the rotor that is currently being used.



The rotor selection can only be changed when the centrifuge is at a standstill.

- Select the "Rotor" field and confirm the selection. The indication "set" flashes in the activated status.
- Select the desired rotor.
- Confirm the input. The selected rotor will be adopted.



Fig. 17: Preselection of a rotor

Automatic rotor identification system

If the centrifuge is equipped with an automatic rotor identification system, the input mode will be activated automatically if the system detects a different rotor than the rotor that is set. If the input mode is aborted, this rotor will be stored nonetheless.

This prevents the maximum permissible speed from being exceeded.

6.3.2.5 Acceleration and deceleration curves

Acceleration

This function is used to select an acceleration curve. The system offers 10 fixed, programmed acceleration curves (curves 0-9).

Brake

This function is used in order to select a curve that decelerates the centrifuge to a standstill. Deceleration curves are inverted images of the acceleration curves and are labelled with identical numbers. Deceleration curve no. 0 represents a brakeless deceleration.



Fig. 18: Preselection of a curve; here: preselection of an acceleration curve



NOTE

Details concerning the acceleration and deceleration curves can be found in .

6.3.2.6 Automatic lid opening function ("AutoOpen")

The automatic lid opening function must be activated so that the lid opens automatically at the end of the operation.

In order to activate the automatic lid opening function:

- Select the "Auto Open" symbol with the cursor and confirm the selection. The symbol and the bar under the symbol start to flash.
- Activate the function by turning the function knob. The symbol remains displayed in a permanent manner and the bar continues to flash.
- Turning the function knob further will deactivate the function. In this case, the symbol disappears but the bar continues to flash.
- Press the function knob in order to activate the desired setting. The bar remains visible as long as the cursor is placed over the symbol.



Fig. 19: The automatic lid opening function "Auto Open" is activated

6.3.2.7 Sound signal ("Buzzer")

This function is used to set an acoustic warning signal that sounds at the end of the centrifugation run and also in the event of an imbalance or error message.

In order to activate the sound signal:

- Select the "Buzzer" symbol with the cursor and confirm the selection. The symbol and the bar under the symbol start to flash.
- Activate the function by turning the function knob. The symbol remains displayed in a permanent manner and the bar continues to flash.
- Turning the function knob further will deactivate the function. In this case, the symbol disappears but the bar continues to flash.
- Press the function knob in order to activate the desired setting. The bar remains visible as long as the cursor is placed over the symbol.



Fig. 20: The sound signal "Buzzer" is activated

6.3.2.8 Program lock ("ProgLock")

When the program lock is active, it is impossible to save any new programs. In this case, the function "save program" is disabled.

In order to activate the program lock:

- Select the "ProgLock" symbol with the cursor and confirm the selection. The symbol and the bar under the symbol start to flash.
- Activate the function by turning the function knob. The symbol remains displayed in a permanent manner and the bar continues to flash.
- Turning the function knob further will deactivate the function. In this case, the symbol disappears but the bar continues to flash.
- Press the function knob in order to activate the desired setting. The bar remains visible as long as the cursor is placed over the symbol.



Fig. 21: The program lock "ProgLock" is activated

6.3.2.9 Cycle display ("Cycles")

In order to activate the cycle display:

- Select the "Cycles" symbol with the cursor and confirm the selection. The symbol is displayed and "set" flashes in front of the rotor display.
- All of the rotors can be selected by turning the function knob. The cycles of the selected rotor are displayed.
- Press the function knob in order to quit the cycle display.

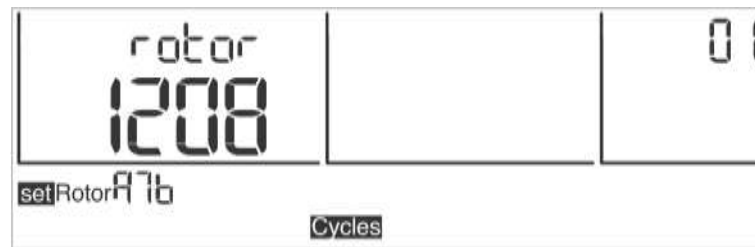

Fig. 22: Cycle display for rotor A7B (example)

Reaching the maximum number of cycles

When the maximum number of cycles is reached for a rotor, a corresponding warning signal will be displayed every time that the centrifuge is started: the start key, lid key, and entire display will flash.

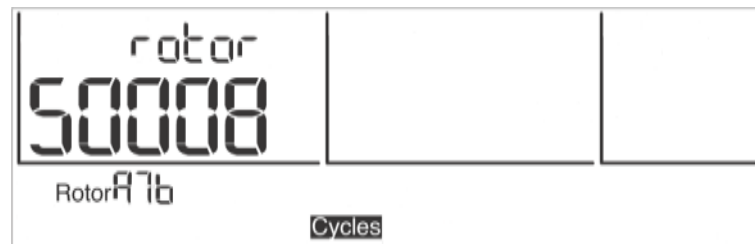

Fig. 23: Display when the maximum number of cycles is reached (flashing)

When the start key is pressed, "CYCLES" will be displayed. The centrifuge will not be started and the display will not return to its normal state until the start key is pressed again.



WARNING

When the maximum number of cycles of the rotor is reached, the rotor must be replaced immediately for safety reasons (see chapter 3.6.7 - "Service life of rotors and accessories").

The cycle display will be reset after the rotor has been replaced by the service department of Sartorius (see chapter 7.3 - "Service contact").

6.3.2.10 Input lock

In order to prevent the centrifuge from being manipulated by unauthorised persons, inputs can be disabled via the menu. Inputs via the keypad, i.e. for starting or stopping a centrifugation run or for opening the lid, are enabled.

Activating a simple input lock:

- Position the cursor over the symbol "🔒" in the lower right-hand corner of the display.

As long as the symbol is displayed, the parameters of the centrifuge cannot be changed.

Activating a permanent input lock:

- Press the start key three times and hold for approximately 2 seconds when pressing it for the third time.

After the activation of this function, the padlock symbol flashes. The input lock is activated.

- Proceed in the same manner in order to deactivate the permanent input lock.



Fig. 24: "Padlock" symbol indicating an activated input lock

6.3.3 Program mode

A program contains all the data that are required for a centrifuge run. Certain sedimentation results can be repeated under identical conditions.

Programs can be saved, loaded, executed, and edited when the centrifuge is at a standstill.

A maximum of 50 programs can be stored under the numbers 1 - 50. The rapid cooling program "Rapid Temp" does not occupy any storage location and cannot be deleted. It is used to cool the centrifuge without any vessels.

"--" means that the values that are currently set are not a stored program.

The programs can be protected against unauthorised use, modification, or deletion with the aid of an input lock (see chapter 6.3.2.10 - "Input lock").

6.3.3.1 Saving a program



NOTE

This function is only available if the centrifuge is at a standstill.

- Enter the parameters that are to be included in the program.
- Select the menu item "save Prog" and confirm the selection. The indication "save" flashes in the activated status.
- Select a random storage location from the program selection list. Free storage locations are indicated by a flashing display. Any storage locations that are already occupied will be overwritten during the saving process.
- Save the program in the desired location.

The program is now saved.



NOTE

The functions "Auto Open", "Buzzer", "ProgLock", and "Cycles" cannot be entered as part of a program.



Fig. 25: Saving a program

6.3.3.2 Loading a program

- Select the menu item "run Prog" and confirm the selection. The indication "run" flashes in the activated status.
- Select the desired program and confirm the selection by pressing the function knob.

The program is now loaded.



Fig. 26: Loading a program

6.4 Switching the centrifuge off

- Open the centrifuge when it is not in use so moisture can evaporate.
- Switch the centrifuge off by pressing the mains power switch.

7 Malfunctions and error correction

7.1 General malfunctions

Error messages are displayed as "Error" followed by a code number. If the acoustic signal is activated, it sounds when the error message is displayed.

- Eliminate the source of the problem (see table below).
- Acknowledge the error messages by pressing the lid key.



NOTE

Error messages can be eliminated by pressing the lid key. The error itself will not be eliminated, but the centrifuge can be operated again.

Type of error	Possible reason	Correction
No indication on the display	No power in the mains supply	Check fuse in the mains supply
	Power cord is not plugged in	Plug in power cord correctly
	Fuses have tripped	Reactivate temperature fuse (see chapter 5.2.1 - "Type of connection")
	Mains power switch off	Switch mains power switch on
Centrifuge cannot be started: start key LED is not illuminated	Several	Power off/on. If the error occurs again, contact service
Centrifuge cannot be started: lid key LED flashes	The lid lock is not closed correctly	Open and close the lid. If the error occurs again, contact service
Centrifuge decelerates during operation	Brief mains power failure	Press start key in order to restart the centrifuge
	System error	Power off/on. If the error occurs again, contact service
Centrifuge decelerates during operation, imbalance message is displayed	<ul style="list-style-type: none"> - Improper loading - Centrifuge is inclined - Drive problem - Centrifuge was moved during run 	Balance load and restart the centrifuge. If the error occurs again, contact service(see chapter 7.1.1 - "Emergency lid release")
	<ul style="list-style-type: none"> - Ungreased load- bearing bolts 	Clean and grease load- bearing bolts
Lid cannot be opened	Lid lock has not released	Unlock the lid manually and contact service
	Lid seal sticks	Clean the lid seal and apply talcum powder
Temperature value cannot be reached (only for refrigerated centrifuges)	Condenser dirty (only air-cooled units)	Clean the condenser. If the error occurs again, contact service

7.1.1 Emergency lid release

In the event of a power failure, it is possible to manually open the centrifuge lid.

- Switch off the mains power switch and disconnect the power cord from the socket.
- Remove the plug (see figure, item 1) from the opening at the side panel, e.g. with a screwdriver.



Fig. 27: Position of the opening for the emergency lid release

- The plug is connected with a string. Pull the string in order to release the lid.
- Then, reinsert the stopper into the opening.



WARNING

Do not unlock or open the lid unless the rotor is at a standstill.

If the lid is opened via the emergency lid release system during a centrifuge run, the centrifuge will be switched off immediately and decelerate in an unbraked manner.

7.2 Table of error codes

Error no.	Kind of error	Measures	Note
1-9	System error	<ul style="list-style-type: none"> Allow to slow down Power off/on 	All these errors stop the centrifuge or cause it to decelerate brakeless
10-19	Speedometer error	<ul style="list-style-type: none"> Allow to slow down Power off/on 	
20-29	Motor error	<ul style="list-style-type: none"> Power off Ensure ventilation 	
30-39	EEPROM error	<ul style="list-style-type: none"> Allow to slow down Power off/on 	With error 34, 35, and 36, the centrifuge will stop; with error 37 and 38 only an error message will be given
40-45	Temperature error (only for refrigerated centrifuges)	<ul style="list-style-type: none"> Allow to slow down Power off Allow to cool down Provide better ventilation (only air cooled centrifuges) Provide sufficient water throughput (only water cooled centrifuges) 	
46-49	Imbalance error	<ul style="list-style-type: none"> Allow to slow down Power off Eliminate the imbalance 	
50-59	Lid error	<ul style="list-style-type: none"> Press lid key Close lid Remove foreign matter from the opening of the lid lock device 	With error 50 and 51, the centrifuge will stop
60-69	Process error	<ul style="list-style-type: none"> Allow to slow down Power off/on 	With error 60 message "power failure during run", with error 61, the message "stop after power on"
70-79	Communication error	<ul style="list-style-type: none"> Allow to slow down Power off/on 	
80-89	Parameter error	<ul style="list-style-type: none"> Power off Allow to cool down Provide for better ventilation 	With error 83, error message only
90-99	Other errors	<ul style="list-style-type: none"> Check connections Provide sufficient water throughput (only water cooled centrifuges) 	



NOTE

If it is impossible to eliminate the errors, contact the service!
Please find the corresponding contact data for your region on our website
www.sartorius.com.

7.3 Service contact

In the event of queries, malfunctions, or spare part enquiries:

Please find the corresponding service contact data for your region on our website www.sartorius.com.



NOTE

- If you would like to utilise our service, please state the type of your centrifuge and its serial number.

8 Maintenance and service

The centrifuge, rotor, and accessories are subject to high mechanical stress. Thorough maintenance performed by the user extends the service life and prevents premature failure.



CAUTION

If corrosion or other damage occurs due to improper care, the manufacturer cannot be held liable or subject to any warranty claims.

- Use soap water or other water-soluble, mild cleaning agents with a pH value between 6 and 8 for cleaning the centrifuge and accessories (see also chapter 8.2 - "Sterilisation and disinfection of the rotor chamber and accessories").
- Avoid corrosive and aggressive substances.
- Do not use solvents.
- Do not use agents with abrasive particles.
- Do not expose the centrifuge and rotors to intensive UV radiation or thermal stress (e.g. by heat generators).

8.1 Maintenance

8.1.1 Centrifuge

- Unplug the mains power plug before cleaning.
- Carefully remove all liquids, including water and particularly all the solvents, acids, and alkaline solutions from the rotor chamber using a cloth in order to avoid damage to the motor bearings.
- If the centrifuge has been contaminated with toxic, radioactive, or pathogenic substances, clean the rotor chamber immediately with a suitable decontamination agent (depending on the type of contamination).



WARNING

Take suitable precautions for your own safety if there is a risk of toxic, radioactive, or pathogenic contamination.

- Grease the motor shaft slightly after cleaning (grease for load-bearing bolts part no. 69CE0006).

8.1.1.1 Condenser (only refrigerated centrifuges)

In order to cool the refrigerant that is compressed by the refrigeration unit, a lamellar condenser is used. It is cooled by air.

Dust and dirt obstruct the cooling flow of air. The dust on condenser pipes and lamellas reduces the heat exchange and thus the performance of the refrigeration unit.

This is why the installation site should be as clean as possible.

- Check the condenser at least once a month for dirt and clean it if necessary.
- If you have any queries, please contact service (see chapter 7.3 - "Service contact").

8.1.2 Accessories



CAUTION

For the care of the accessories, special safety measures must be considered as these are measures that will ensure operational safety at the same time!

- Immediately rinse off the rotor, buckets, or accessories under running water if they have come into contact with any liquids that may cause corrosion. Use a brush for test tubes in order to clean the bores of angle rotors. Turn the rotor upside down and allow it to dry completely.
- Clean the accessories outside the centrifuge once a week or preferably after each use. Adapters should be removed, cleaned and dried.



CAUTION

Do not clean the accessories in a dishwasher!

Cleaning in a dishwasher removes the anodised coating; the result is cracking in areas that are subject to stress.

- If the rotors or accessories have been contaminated with toxic, radioactive, or pathogenic substances, clean them immediately with a suitable decontamination agent (depending on the type of contamination). Take suitable precautions for your own safety if there is a risk of toxic, radioactive, or pathogenic contamination.
- Dry the accessories with a soft cloth or in a drying chamber at approx. 50°C.

8.1.2.1 Plastic accessories

The chemical resistance of plastic decreases with rising temperatures (see chapter 11.4 - "Resistance data").

- If solvents, acids, or alkaline solutions have been used, clean the plastic accessories thoroughly.



WARNING

Plastic accessories must not be greased!

8.1.3 Rotors, buckets and carriers

Rotors, buckets and carriers are produced with the highest precision, in order to withstand the permanent high stress from high gravitational fields.

Chemical reactions as well as stress-corrosion (combination of oscillating pressure and chemical reaction) can affect or destroy the metals. Barely detectable cracks on the surface can expand and weaken the material without any visible signs.

- Check the material regularly (at least once a month) for
 - cracks
 - visible damage of the surface
 - pressure marks
 - signs of corrosion
 - other changes.
- Check the bores of the rotors and multiple carriers.
- Replace any damaged components immediately for your own safety.
- Grease the rotor tie-down screw after cleaning with grease for load bearing bolts (part no. 69CE0006) and spread the grease with a cloth.

8.1.4 Load bearing bolts

Only greased load bearing bolts ensure the even swinging of the buckets and, therefore, the quiet run of the centrifuge. Non-greased bolts can lead to a system shut-down due to imbalances.

Apply a small quantity of grease (part no. 69CE0006) to the load bearing bolts of the rotor and buckets after each cleaning.

8.1.5 Glass breakage



CAUTION

In the case of glass breakage, immediately remove all glass particles (e.g. with a vacuum cleaner). Replace the rubber cushions since even thorough cleaning will not remove all glass particles.

Glass particles will damage the surface coating (e.g. anodising) of the buckets, which will then lead to corrosion.

Glass particles in the rubber cushions of the buckets will cause glass breakage again.

Glass particles on the pivot bearing of the load-bearing bolts prevent the buckets and carriers from swinging evenly, which will cause an imbalance.

Glass particles in the rotor chamber will cause metal abrasion due to the strong air circulation. This metal dust will not only pollute the rotor chamber, rotor, and materials to be centrifuged but also damage the surfaces of the accessories, rotors, and rotor chamber.

In order to completely remove the glass particles and metal dust from the rotor chamber:

- Grease the upper third of the rotor chamber with e.g. Vaseline.
- Then, let the rotor rotate for a few minutes at a moderate speed (approx. 2000 rpm). The glass and metal particles will now collect at the greased part.
- Remove the grease with the glass and metal particles with a cloth.
- If necessary, repeat this procedure.

8.2 Sterilisation and disinfection of the rotor chamber and accessories

- Use commercially-available disinfectants such as, for example, Sagrotan[®], Buraton[®], or Terralin[®] (available at chemist's shops or drugstores).
- The centrifuge and the accessories consist of various materials. A possible incompatibility must be considered.
- Before using cleaning or decontamination agents that were not recommended by us, contact the manufacturer to ensure that such a procedure will not damage the centrifuge.
- For autoclaving, consider the continuous heat resistance of the individual materials (see chapter 8.2.1 - "Autoclaving").

Please contact us if you have any queries (see chapter 7.3 - "Service contact").



DANGER

If dangerous materials (e.g. infectious and pathogenic substances) are used, the centrifuge and accessories must be disinfected.

8.2.1 Autoclaving

The service life of the accessories essentially depends on the frequency of autoclaving and use.

- Replace the accessories immediately when the parts show changes in colour or structure or in the occurrence of leaks etc.
- During autoclaving, the caps of the tubes must not be screwed on in order to avoid the deformation of the tubes.



NOTE

It cannot be excluded that plastic parts, e.g. lids or carriers, may deform during autoclaving.

Accessories	Max. temp. (°C)	Min. time (min)	Max. time (min)	Max. cycles
Aluminium buckets	134-138	3	5	-
Aluminium rotors	134-138	3	5	-
Glass tubes	134-138	3	40	-
Polyallomer / polycarbonate rectangular carriers	115-118	30	40	-
Polyallomer / polycarbonate round carriers	115-118	30	40	-
Polyamide buckets	115-118	30	40	10
Polycarbonate / polyallomer lids for angle rotors	115-118	30	40	20
Polycarbonate tubes	115-118	30	40	20
Polyphenylsulfone (PPSU) caps for buckets	134-138	3	5	100
Polypropylene balance adapter for blood-bag systems	115-118	30	40	n.s.
Polypropylene copolymer tubes	115-121	30	40	20
Polypropylene rectangular carriers	115-118	30	40	-
Polypropylene rotors	115-118	30	40	20
Polypropylene round carriers	115-118	30	40	-
Polysulfone caps for buckets	134-138	3	5	100
Polysulfone lids for angle rotors	134-138	3	5	100
Rubber adapters	115-118	30	40	-
Stainless-steel balance weight for blood-bag systems	121	30	30	n.s.
Teflon tubes	134-138	3	5	100

8.3 Service



DANGER

In the event of service work that requires the removal of the panels, there is a risk of electric shock or mechanical injury. Only qualified specialist personnel is authorised to perform this service work.

The centrifuge is subject to high mechanical stress. In order to be able to withstand this high level of stress, high-quality components were used during the production of the centrifuge. Nevertheless, wear cannot be excluded and it may not be visible from the outside. Especially the rubber parts that are – among other things – part of the motor suspension, are subject to ageing.

This is why we recommend having the centrifuge checked by the manufacturer during an inspection once per year in the operating state and once every three years in the dismantled state. Rubber parts should be replaced after three years.

Information and appointments

Please find the corresponding contact data for your region on our website www.sartorius.com.



NOTE

- If you would like to utilise our service, please state the type of your centrifuge and its serial number.

8.4 Return of defective units

Although we exercise great care during the production of our products, it may be necessary to return a unit or accessory to the manufacturer.

In order to ensure the quick and economical processing of returns of centrifuges, spare parts, or accessories, we require complete and extensive information concerning the process. Please fill in the following forms completely, sign them, enclose them with the return package, and send them together with the product.

1. Declaration of decontamination

As a certified company and due to the legal regulations for the protection of our employees and of the environment, we are obliged to certify the harmlessness of all incoming goods. For this purpose, we require a declaration of decontamination.

- The form must be filled in completely and signed by authorised and specialised personnel only.
- Affix the original form in a clearly visible manner to the outside of the packaging.



NOTE

We will return the unit if no declaration of decontamination is provided!

2. Form for the return of defective units

This form is for the product-related data. They facilitate the assignment, and they enable the quick processing of the return. If several units are returned together in one packaging, please enclose a separate problem description for every defective unit.

- A detailed problem description is necessary in order to perform the repair quickly and economically.



NOTE

If the form does not include a description of the malfunction, neither a refund nor a credit note can be issued. In this case, we reserve the right to return the unit to you at your expense.

- Please note on the form if you would like to receive a cost estimate. Cost estimates are only prepared upon request and against charge. If an order is placed, these charges will be offset.

The forms can be downloaded online from www.sartorius.com.

9 Disposal



The packaging is made from environmentally-friendly materials that can be used as secondary raw materials. If you no longer need this packaging, bring it to your local recycling and waste disposal facility according to the regulations applicable in your country. In Germany, you can dispose of this material using the VfW dual system (contract number D-59101-2009-1129). The equipment, including accessories and batteries, must not be disposed of in general household waste, and must be recycled similar to electrical and electronic devices. For further information about disposal and recycling option, please contact your local service staff. The partners listed on the following website can be used for disposals within the EU:

1. Go to <http://www.sartorius.com>.
2. Select the summary under "Service".
3. Then select "Information on Disposal".
4. Adresses for local Sartorius disposal contacts can be found in the pdf-files given on this webpage.



NOTE

Sartorius will not take back equipment contaminated with hazardous materials (ABC contamination) either for repair or disposal.

Service adress for disposal:

Please refer to our website (www.sartorius.com) or contact the Sartorius Service Department for more detailed information regarding repair service addresses or the disposal of your device.

10 Technical data

Manufacturer:	Sartorius Lab Instruments GmbH & Co. KG Weender Landstraße 94 – 108 37075 Göttingen Germany
Type:	Centrisart® G-16C
<u>Connection data</u>	
Electr. connection	see the name plate
Protection class:	I
IP code:	20
Connected load (kVA):	1.4 (at 220-240 V / 50-60 Hz) 1.3 (at 120 V / 60 Hz) 1.3 (at 100 V / 50-60 Hz)
Power consumption (kW):	1.01 (at 220-240 V / 50-60 Hz) 1.03 (at 120 V / 60 Hz) 1.06 (at 100 V / 50-60 Hz)
Max. current consumption (A):	5.9 (at 220-240 V / 50-60 Hz) 11.0 (at 120 V / 60 Hz) 13.5 (at 100 V / 50-60 Hz)
Thermal circuit breaker (A):	10.0 (at 220-240 V / 50-60 Hz) 16.0 (at 120 V / 60 Hz) 16.0 (at 100 V / 50-60 Hz)
<u>Performance data</u>	
Max. speed (rpm):	15,300
Max. capacity (ml):	1,600 (4 x 400)
Max. gravitational field (x g):	21,913
Max. kin. energy (Nm):	9,970
<u>Other parameters</u>	
Time range:	10 sec – 99 h 59 min, short run, continuous run
Temperature range:	-10°C to +40°C
Storage locations:	50
<u>Physical data</u>	
Height (mm):	355
Height with open lid (mm):	785
Width (mm):	630
Depth (mm):	600
Weight (kg):	78
Noise level (dB(A)):	57 (at max. speed)
<u>Refrigerant data</u>	
Refrigerant:	R134a
Filling quantity (kg):	0.375
Pressure (bar):	25
CO ₂ equivalent (t):	0.488

10.1 Ambient conditions

- The figures are valid for an ambient temperature of $+23^{\circ}\text{C} \pm 2^{\circ}\text{C}$ and a nominal voltage $\pm 10\%$. The minimum temperature is $< +4^{\circ}\text{C}$ and depends on the rotor type, speed, and ambient temperature.



NOTE

At a nominal voltage of 100V or 200V, a tolerance of +10% / -5% applies.

- For indoor use only.
- Allowable ambient temperature $+5^{\circ}\text{C}$ to $+35^{\circ}\text{C}$.
- Max. relative humidity of air 80% up to 31°C with a linear decrease to 67% relative humidity of air at 35°C .
- Maximum altitude 2,000 m above sea level.

11 Appendix

11.1 Range of accessories

Part no.	Description	Max. speed (rpm)	Max. gravitational field (x g)
S2B-G16	Swing-out rotor, 4 places, for bucket no. B8Bdia85mmS2B	4 500	
S6B-MT00002-G16	Swing-out rotor for microtiter plates, biosafe certificate, incl. 1 set buckets no. B1CMT0002-S6B, 1 set caps no. YCLidB1C and plate holder no. 69CE0007, max. height of plates 55 mm, without cap max. 66 mm, max. load per bucket approx. 290 grams Radius max. 13.3 cm, radius min. 4.4 cm	4 200	2 623
A5B6x50mLSTG16	Fixed angle rotor 6 x 50 ml, for Centrisart® G-16C, incl. hermetic aluminium lid Radius max. 8.4 cm, radius min. 2.1 cm, angle 25°	11 000	11 363
A6B24x1.5mLRVG16	Fixed angle rotor 24 x 1,5/2 ml, for Centrisart® G-16C, incl. hermetic aluminium lid Radius max. 8.2 cm, radius min. 5.0 cm, angle 45°	15 300	21 460
A7B4x80mLSTG16	Fixed angle rotor 4 x 80/85 ml, for Centrisart® G-16C, incl. hermetic aluminium lid Radius max. 9.1 cm, radius min. 1.4 cm, angle 26°	10 000	10 174
A8B6x85mLSTG16	Fixed angle rotor 6 x 85 ml, for Centrisart® G-16C, incl. hermetic aluminium lid Radius max. 9.8 cm, min. Radius 2.8 cm, angle 25°	8 000	7 012
A0B6x50mLCTG16	Fixed angle rotor 6 x 50 ml, for Centrisart® G-16C, incl. hermetic aluminium lid	9 500	9 384
B8Bdia85mmS2B	Round bucket, biosafe certificate, sealable with cap no. YCLidB8B, max. tube length 110 mm, 1 set = 2 pcs. Radius max. 17.2 cm, radius min. 7.5 cm	4 500	3 894

Adapters

Part no.	Description
YCA0.25mLRV	Adapter for reaction vials 0.25/0.4 ml, 1 set = 2 pcs.
YCA0.5mLRV	Adapter for reaction vials 0.5/0.75 ml, Ø 7.9/10 x 28/31 mm, 1 set = 2 pcs.
YCA1.5mLRV	Adapter for 1.5 ml reaction vials for g-forces exceeding 20.000 x g, 1 set = 2 pcs.
YCA0.2mLPCR	Adapter for PCR-tube 0.2 m, 1 set = 2 pcs.
YCA15mLCT	Adapter for 1 culture tube 15 m, 1 set = 2 pcs.

The complete list of accessories can be downloaded from www.sartorius.com.

11.1.1 Maximum speed for tubes

Some tubes, such as centrifuge glass tubes, microtubes, culture tubes, fluoropolymer tubes and especially high-volume tubes can be used in our rotors, buckets, and adapters at higher speeds than their breaking limit.

- Always fill the tubes up to their useful volume (= the volume that is stated for the tube).
- When using glass tubes, the maximum value of 4,000 x g must not be exceeded (except special high-strength glass tubes; please refer to the information provided by the manufacturer).

11.1.2 Rotor radii

The information in the accessories table concerning the radius refers to the values of the respective rotor as shown below. The radius calculation is described in chapter 2.2.2.1 - "Speed, radius, and relative centrifugal force".

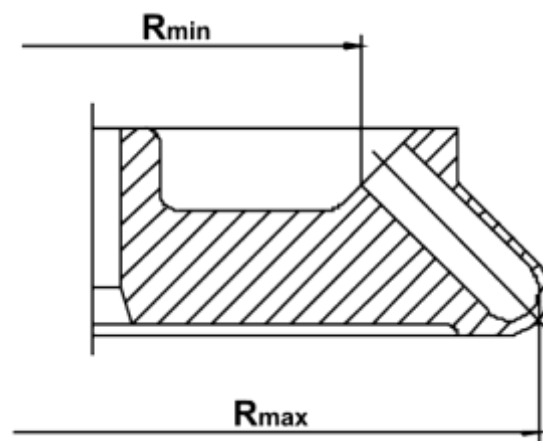

Fig. 28: Minimum and maximum radius of an angle rotor

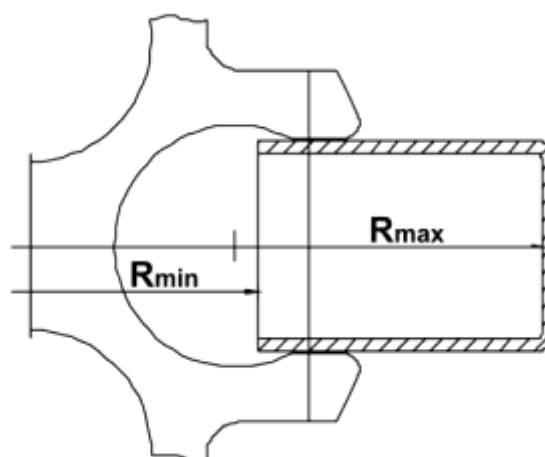

Fig. 29: Minimum and maximum radius of a swing-out rotor

11.2 Speed-gravitational-field-diagram

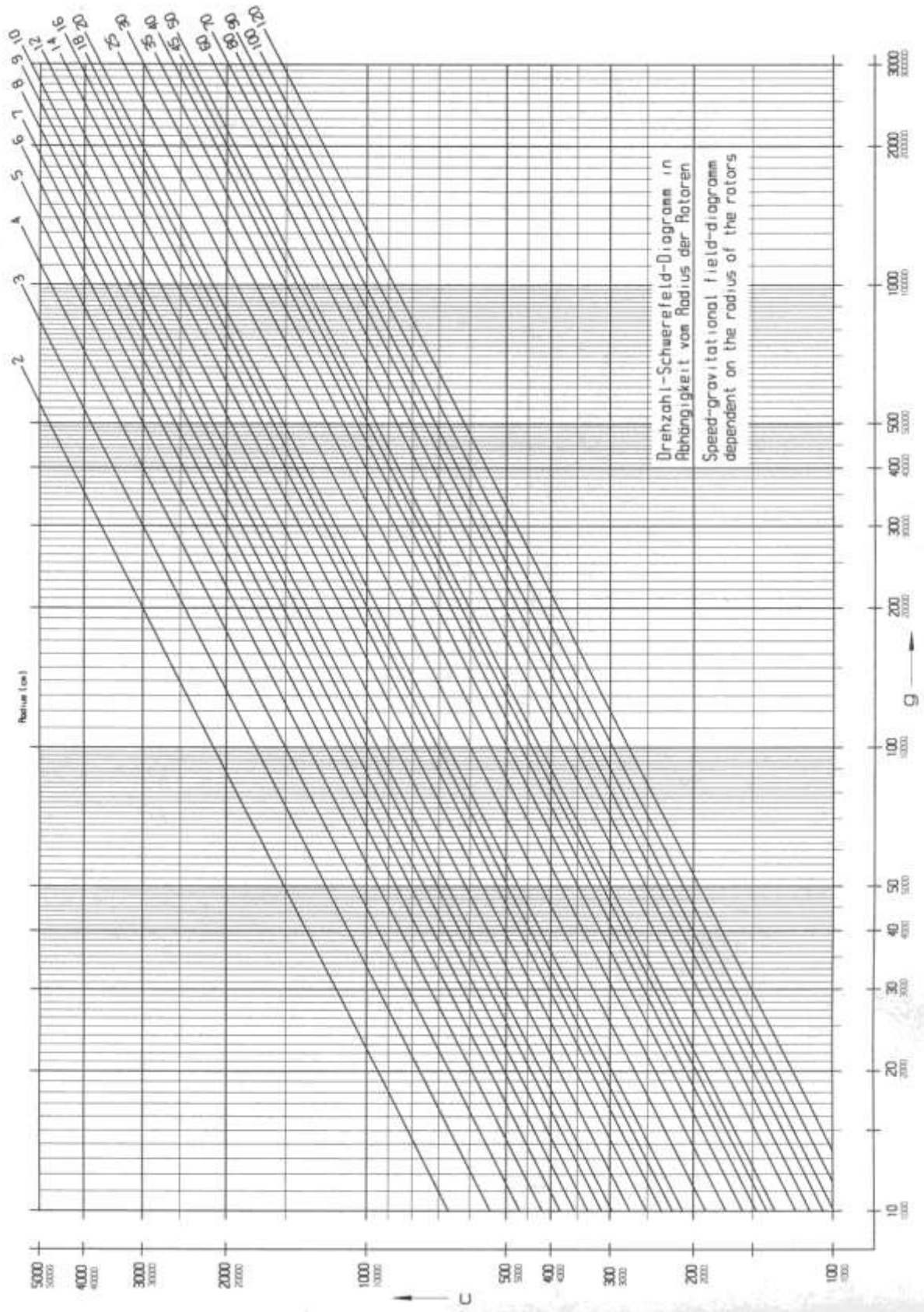

Fig. 30: Speed-gravitational-field-diagram

11.3 Acceleration and deceleration curves

Linear curves are numbered in the direction of increasing acceleration (from right to left).

The deceleration curves are inverted images of the acceleration curves and are assigned the same numbers. An exception is curve 0. It decelerates brakeless (spin-out).

In general, the runtime, until the set speed is reached, depends on the moment of inertia of the rotor.

Linear curves

The slope of the fixed acceleration curves defines the time that is required to accelerate the rotor by 1,000 rpm.

Curve 9 is a special case compared to the other curves. The centrifuge accelerates with maximum power. The runtime, until the set speed is reached, depends solely on the moment of inertia of the rotor.

Linear curve no.	Slop
0	4 [rpm/sec]
1	6 [rpm/sec]
2	8 [rpm/sec]
3	17 [rpm/sec]
4	25 [rpm/sec]
5	33 [rpm/sec]
6	50 [rpm/sec]
7	100 [rpm/sec]
8	200 [rpm/sec]
9	1.000 [rpm/sec]

Fig. 31: Slope of linear curves

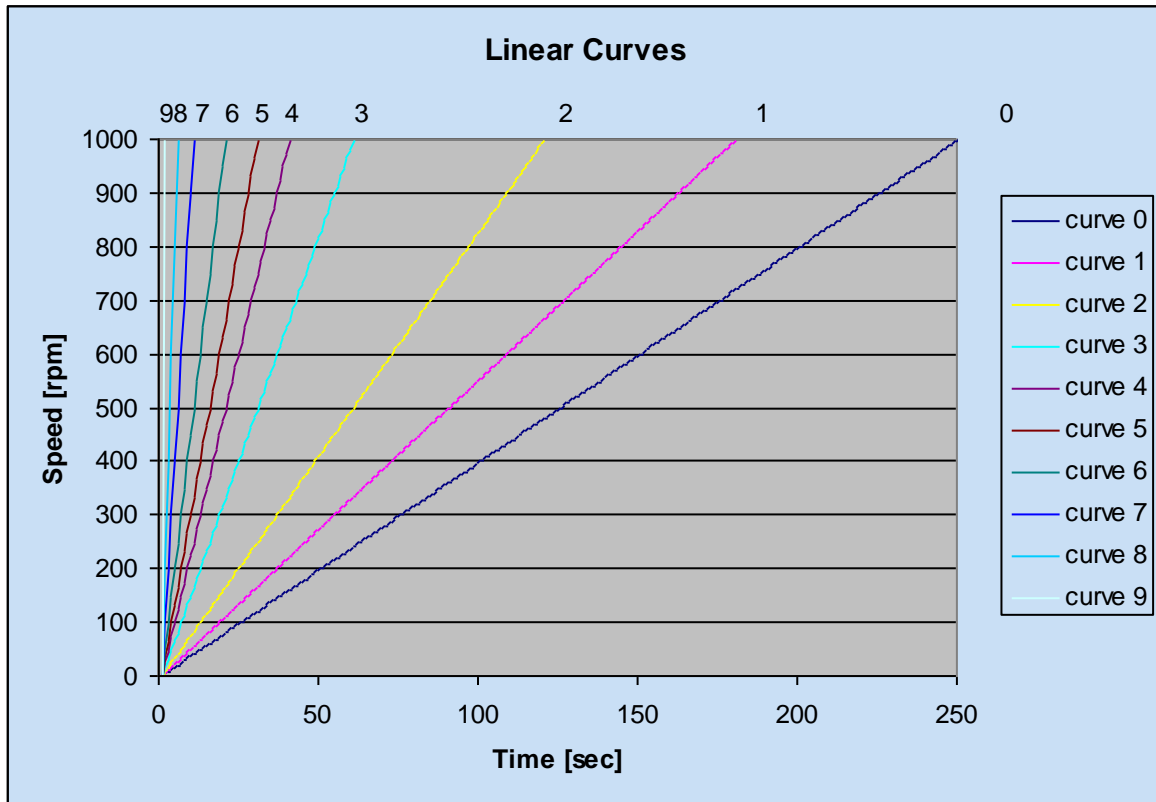

Fig. 32: Diagram of linear curves

11.4 Resistance data



NOTE

The data refer to resistance at 20°C.

Medium	Formula	Concentration [%]	High Density Polyethylene HDPE	Polyamide PA	Polycarbonate PC	Polyoxymethylene POM	Polypropylene PP	Polysulfone PSU	Polyvinyl chloride, hard PVC	Polyvinyl chloride, weak PVC	Polytetrafluorethylene PTFE	Acrylonitrile-butadiene- caoutchouc NBR	Aluminium AL
Acetaldehyde	C ₂ H ₄ O	40	3	2	4	2	3	4	4	-	1	4	1
Acetamide	C ₂ H ₅ NO	saturated	1	1	4	1	1	4	4	-	1	-	1
Acetone	C ₃ H ₆ O	100	1	1	4	1	1	4	4	-	1	4	1
Acrylonitrile	C ₃ H ₃ N	100	1	1	4	3	3	4	4	4	1	4	1
Allyl alcohol	C ₃ H ₆ O	96	1	3	3	2	2	2	2	4	1	1	1
Aluminium chloride	AlCl ₃	saturated	1	3	2	4	1	-	1	-	1	1	4
Aluminium sulfate	Al ₂ (SO ₄) ₃	10	1	1	1	3	1	1	1	1	1	1	1
Ammonium chloride	(NH ₄)Cl	aqueous	1	1	1	2	1	1	1	1	1	1	3
Ammonium hydroxide	NH ₃ + H ₂ O	30	1	3	4	1	1	2	1	-	1	-	1
Aniline	C ₆ H ₇ N	100	1	3	4	1	2	4	4	4	1	4	1
Anisole	C ₇ H ₈ O	100	3	4	4	1	4	4	2	-	1	4	1
Antimony trichloride	SbCl ₃	90	1	4	1	4	1	-	1	-	1	-	4
Benzaldehyde	C ₇ H ₆ O	100	1	3	4	1	1	3	4	4	1	4	1
Benzene	C ₆ H ₆	100	3	2	4	1	3	4	4	-	1	4	1
Boric acid	H ₃ BO ₃	aqueous	1	3	1	2	1	-	-	-	1	1	1
Butyl acrylate	C ₇ H ₁₂ O ₂	100	1	2	4	2	3	4	4	4	1	-	1
Butyl alcohol, normal	C ₄ H ₁₀ O	100	1	1	2	1	1	2	2	4	1	1	1
Calcium chloride	CaCl ₂	alcoholic	1	4	2	3	1	-	-	4	1	1	3
Carbon disulfide	CS ₂	100	4	3	4	2	4	4	4	4	1	3	1
Carbon tetrachloride (TETRA)	CCl ₄	100	4	4	4	2	4	4	4	4	1	3	1
Chlorine	Cl ₂	100	4	4	4	4	4	4	4	4	1	-	3
Chlorine water	Cl ₂ x H ₂ O		3	4	4	4	3	-	3	3	1	-	4
Chlorobenzene	C ₆ H ₅ Cl	100	3	4	4	1	3	4	4	4	1	4	1
Chloroform	CHCl ₃	100	3	3	4	4	3	4	4	4	1	4	3

11 Appendix



Medium	Formula	Concentration [%]	- no data 1 resistant 2 practically resistant 3 partially resistant 4 not resistant										
			High Density Polyethylene	Polyamide	Polycarbonate	Polyoxymethylene	Polypropylene	Polysulfone	Polyvinyl chloride, hard	Polyvinyl chloride, weak	Polytetrafluorethylene	Acrylonitrile-butadiene-caoutchouc	Aluminium
Medium	Formula	[%]	HDPE	PA	PC	POM	PP	PSU	PVC	PVC	PTFE	NBR	AL
Chromic acid	CrO ₃	10	1	4	2	4	1	4	1	-	1	4	1
Chromic potassium sulphate	KCr(SO ₄) ₂ x 12H ₂ O	saturated	1	2	1	3	1	-	1	-	1	-	3
Citric acid	C ₆ H ₈ O ₇	10	1	1	1	2	1	1	1	1	1	1	1
Citric acid	C ₆ H ₈ O ₇	50	1	3	1	2	1	-	-	-	1	1	1
Copper sulphate	CuSO ₄ x 5H ₂ O	10	1	1	1	1	1	1	1	1	1	1	4
Cyclohexanol	C ₆ H ₁₂ O	100	1	1	3	1	1	1	1	4	1	2	1
Decane	C ₁₀ H ₂₂	100	-	1	2	1	3	-	-	-	1	2	1
Diaminoethane	C ₂ H ₈ N ₂	100	1	1	3	1	1	-	3	4	1	1	1
Diesel fuel	—	100	1	1	3	1	1	-	1	3	1	1	1
Dimethyl formamide (DMF)	C ₃ D ₇ NO	100	1	1	4	1	1	4	3	-	1	3	1
Dimethyl sulfoxide (DMSO)	C ₂ H ₆ SO	100	1	2	4	1	1	4	4	-	1	-	1
Dimethylaniline	C ₈ H ₁₁ N	100	-	3	4	2	4	-	-	-	1	-	1
Dioxane	C ₄ H ₈ O ₂	100	2	1	4	1	3	2	3	4	1	3	1
Dipropylene glycol (mono)methyl ether	C ₄ H ₁₀ O	100	3	1	4	1	4	4	4	4	1	-	1
Ethyl acetate	C ₄ H ₈ O ₂	100	1	1	4	1	1	4	4	4	1	4	1
Ethylene chloride	C ₂ H ₄ Cl ₂	100	3	3	4	1	3	4	4	4	1	-	1
Ferrous chloride	FeCl ₂	saturated	1	3	1	3	1	1	1	1	1	-	4
Formaldehyde solution	CH ₂ O	30	1	3	1	1	1	-	-	-	1	2	1
Formic acid	CH ₂ O ₂	100	1	4	3	4	1	3	3	1	1	2	1
Furfural	C ₅ H ₄ O ₂	100	1	3	3	2	4	-	-	-	1	4	1
Gasoline	C ₅ H ₁₂ - C ₁₂ H ₂₆	100	2	1	3	1	3	3	2	-	1	1	1
Glycerol	C ₃ H ₈ O ₃	100	1	1	3	1	1	1	1	2	1	1	1
Heptane, normal	C ₇ H ₁₆	100	2	1	1	1	2	1	2	4	1	1	1
Hexane, n-	C ₆ H ₁₄	100	2	1	2	1	2	1	2	4	1	1	1
Hydrogen chloride	HCl	5	1	4	1	4	1	1	1	-	1	2	4
Hydrogen chloride	HCl	concentrated	1	4	4	4	1	1	2	3	1	4	4
Hydrogen peroxide	H ₂ O ₂	3	1	3	1	1	1	1	1	-	1	3	3
Hydrogen peroxide	H ₂ O ₂	30	1	4	1	4	1	1	1	-	1	3	3
Hydrogen sulphide	H ₂ S	10	1	1	1	1	1	1	1	3	1	3	1

Medium	Formula	Concentration [%]	- no data 1 resistant 2 practically resistant 3 partially resistant 4 not resistant										
			High Density Polyethylene	Polyamide	Polycarbonate	Polyoxymethylene	Polypropylene	Polysulfone	Polyvinyl chloride, hard	Polyvinyl chloride, weak	Polytetrafluorethylene	Acrylonitrile-butadiene-caoutchouc	Aluminium
Medium	Formula	[%]	HDPE	PA	PC	POM	PP	PSU	PVC	PVC	PTFE	NBR	AL
Iodine, tincture of	I ₂		1	4	3	1	1	-	4	4	1	1	1
Isopropyl alcohol	C ₃ H ₈ O	100	1	1	1	1	1	1	1	4	1	-	2
Lactic acid	C ₃ H ₆ O ₃	3	1	3	1	2	1	1	2	-	1	1	1
Magnesium chloride	MgCl ₂	10	1	1	1	1	1	1	1	1	1	1	1
Mercuric chloride	HgCl ₂	10	1	4	1	3	1	1	1	1	1	1	4
Mercury	Hg	100	1	1	1	1	1	1	1	3	1	1	3
Methyl acetate	C ₃ H ₆ O ₂	100	1	1	4	2	1	-	4	4	1	-	1
Methyl alcohol	CH ₄ O	100	1	2	4	1	1	3	1	3	1	2	1
Methyl benzene	C ₇ H ₈	100	3	1	4	1	3	4	4	4	1	4	1
Methyl ethyl ketone (MEK)	C ₄ H ₈ O	100	1	1	4	1	1	4	4	4	1	4	1
Methylene chloride	CH ₂ Cl ₂	100	4	3	4	3	3	4	4	4	1	-	1
Mineral oil	—	100	1	1	1	1	1	1	1	-	1	1	1
Nitric acid	HNO ₃	10	1	4	1	4	1	1	1	-	1	4	3
Nitric acid	HNO ₃	100	4	4	4	4	4	-	4	-	1	4	1
Nitrobenzene	C ₆ H ₅ NO ₂	100	3	4	4	3	2	4	4	4	1	4	1
Oleic acid	C ₁₈ H ₃₄ O ₂	100	1	1	1	2	1	-	1	-	1	3	1
Oxalic acid	C ₂ H ₂ O ₄ x 2H ₂ O	100	1	3	1	4	1	1	1	1	1	2	1
Ozone	O ₃	100	3	4	1	4	3	1	1	-	1	4	2
Petroleum	—	100	1	1	3	1	1	1	1	3	1	1	1
Phenol	C ₆ H ₆ O	10	1	4	4	4	1	4	1	3	1	3	1
Phenol	C ₆ H ₆ O	100	2	4	4	4	1	3	4	3	1	3	1
Phosphoric acid	H ₃ PO ₄	20	1	4	2	4	1	-	-	-	1	2	4
Phosphorus pentachloride	PCl ₅	100	-	4	4	4	1	-	4	4	1	-	1
Potassium hydrogen carbonate	CHKO ₃	saturated	1	1	2	1	1	-	-	-	1	-	4
Potassium hydroxide	KOH	30	1	1	4	3	1	1	1	1	1	-	4
Potassium hydroxide	KOH	50	1	1	4	3	1	1	1	1	1	-	4
Potassium nitrate	KNO ₃	10	1	1	1	1	1	-	-	-	1	1	1
Potassium permanganate	KMnO ₄	100	1	4	1	1	1	-	1	-	1	3	1
Pyridine	C ₅ H ₅ N	100	1	1	4	1	3	4	4	4	1	4	1
Resorcinol	C ₆ H ₆ O ₂	5	1	4	2	3	1	4	2	-	1	-	2
Silver nitrate	AgNO ₃	100	1	1	1	1	1	1	1	1	1	2	4

11 Appendix

Medium	Formula	Concentration [%]	- no data 1 resistant 2 practically resistant 3 partially resistant 4 not resistant	High Density Polyethylene	Polyamide	Polycarbonate	Polyoxymethylene	Polypropylene	Polysulfone	Polyvinyl chloride, hard	Polyvinyl chloride, weak	Polytetrafluorethylene	Acrylonitrile-butadiene-caoutchouc	Aluminium
			HDPE	PA	PC	POM	PP	PSU	PVC	PVC	PTFE	NBR	AL	
Sodium bisulphite	NaHSO ₃	10	1	1	2	4	1	-	-	-	1	1	1	
Sodium carbonate	Na ₂ CO ₃	10	1	1	1	1	1	-	-	-	1	-	3	
Sodium chloride	NaCl	30	1	1	1	1	1	1	1	1	1	1	3	
Sodium hydroxide	NaOH	30	1	1	4	1	1	1	1	1	1	2	4	
Sodium hydroxide	NaOH	50	1	1	4	1	1	1	1	-	1	2	4	
Sodium sulfate	Na ₂ SO ₄	10	1	1	1	1	1	1	1	1	1	1	1	
Spirits	C ₂ H ₆ O	96	1	1	1	1	1	1	1	3	1	-	1	
Styrene	C ₈ H ₈	100	4	1	4	1	3	-	4	4	1	4	1	
Sulphuric acid	H ₂ SO ₄	6	1	4	1	4	1	1	1	-	1	2	3	
Sulphuric acid	H ₂ SO ₄	fuming	4	4	4	4	4	4	4	4	1	4	3	
Tallow	-	100	1	1	1	1	1	-	1	1	1	1	1	
Tetrahydrofuran (THF)	C ₄ H ₈ O	100	3	1	4	1	3	4	4	4	1	3	1	
Tetrahydronaphthalene	C ₁₀ H ₁₂	100	3	1	4	1	4	4	4	4	1	-	1	
Thionyl chloride	Cl ₂ SO	100	4	4	4	2	4	4	4	4	1	-	3	
Tin chloride	SnCl ₂	10	1	4	2	2	1	-	-	-	1	1	4	
Transformer oil	-	100	1	1	3	3	1	1	1	-	1	1	1	
Trichloroethane	C ₂ H ₃ Cl ₃	100	3	3	4	2	4	4	4	4	1	4	4	
Urea	CH ₄ N ₂ O	10	1	1	1	1	1	-	-	-	1	1	1	
Urine	-	100	1	1	1	1	1	-	1	1	1	-	2	
Vinegar	C ₂ H ₄ O ₂	10	1	4	1	1	1	1	1	1	1	2	1	
Vinegar	C ₂ H ₄ O ₂	90	1	4	4	4	1	3	1	4	1	-	1	
Wax	-	100	-	1	1		1	-	-	-	1	-	1	
Wines	-	100	1	1	1	2	1	1	1	1	1	-	4	
Xylene	C ₈ H ₁₀	100	3	1	4	1	4	4	4	4	1	4	1	

11.5 EC declaration of conformity

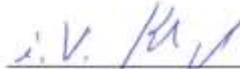
Original		
	EG-/EU-Konformitätserklärung EC / EU Declaration of Conformity	
Hersteller <i>Manufacturer</i>	Sartorius Lab Instruments GmbH & Co. KG 37070 Goettingen, Germany	
	erklärt in alleiniger Verantwortung, dass das Betriebsmittel <i>declares under sole responsibility that the equipment</i>	
Geräteart <i>Device type</i>	Zentrifuge <i>Centrifuge</i>	
Baureihe <i>Type series</i>	Centrisart® G-16	
Modell / Model	G-16-1EU, G-16-1US, G-16-1JP, G-16C-1EU, G-16C-1US, G-16C-1JP	
	in der von uns in Verkehr gebrachten Ausführung allen einschlägigen Bestimmungen der folgenden Europäischen Richtlinien - einschließlich deren zum Zeitpunkt der Erklärung geltenden Änderungen - entspricht und die anwendbaren Anforderungen folgender harmonisierter Europäischer Normen erfüllt: <i>in the form as delivered fulfils all the relevant provisions of the following European Directives - including any amendments valid at the time this declaration was signed - and meets the applicable requirements of the harmonized European Standards listed below:</i>	
2014/30/EU	Elektromagnetische Verträglichkeit <i>Electromagnetic compatibility</i> EN 61326-1:2013	
2011/65/EU	Beschränkung der Verwendung bestimmter gefährlicher Stoffe in Elektro- und Elektronikgeräten (RoHS) <i>Restriction of the use of certain hazardous substances in electrical and electronic equipment (RoHS)</i> EN 50581:2012	
2006/42/EG 2006/42/EC	Maschinen <i>Machines</i> EN ISO 12100:2010, EN 61010-1:2010	
	Die Person, die bevollmächtigt ist, die technischen Unterlagen zusammenzustellen: <i>The person authorised to compile the technical file:</i>	
	Sartorius Lab Instruments GmbH & Co. KG International Certification Management 37070 Goettingen, Germany	
	Jahreszahl der CE-Kennzeichenvergabe <i>Year of the CE mark assignment:</i> 16	
	Sartorius Lab Instruments GmbH & Co. KG Goettingen, 2016-04-20	
		
	Dr. Reinhard Baumfalk Vice President R&D	Dr. Dieter Klausgrete Head of International Certification Management
	Diese Erklärung bescheinigt die Übereinstimmung mit den genannten EG- und EU-Richtlinien, ist jedoch keine Zusicherung von Eigenschaften. Bei einer mit uns nicht abgestimmten Änderung des Produktes verliert diese Erklärung ihre Gültigkeit. Die Sicherheitshinweise der zugehörigen Produktdokumentation sind zu beachten. <i>This declaration certifies conformity with the above mentioned EC and EU Directives, but does not guarantee product attributes. Unauthorised product modifications make this declaration invalid. The safety information in the associated product documentation must be observed.</i>	
	Doc: 2034276-01 SLI15CE007-01.de,en 1 / 1 PMF: 2034275 OP-113_fo1_2015.10.12	

12 Index

A

Acceleration.....	37
Acceleration curve.....	60
Acceleration curves.....	37
Accessories, cleaning and care.....	48
Acid.....	20, 47, 49
Activating the modification mode.....	31
Adapters.....	29, 48
Alkaline solutions.....	20, 47, 49
Ambient conditions.....	56
Ambient temperature.....	56
Anodised coating.....	48
Application examples.....	13
Autoclaving.....	51
Automatic lid opening function.....	37
AutoOpen.....	37

B

Box spanner, size 10 (rotor fastening).....	10
Brake.....	37
Brief mains power failure.....	43
Bucket.....	29
Buckets, cleaning and care.....	49
Buzzer.....	38

C

Capacity.....	55
Carrier.....	29
Carrier systems.....	29
Carriers, cleaning and care.....	49
CE mark in compliance with the directive 2006/42/EC.....	15
Centrifugation of infectious, toxic, radioactive, or pathogenic substances.....	19
Centrifugation principle.....	13
Centrifugation with different tube sizes.....	28
Centrifugation with low capacity.....	29
Centrifuge cannot be started.....	43
Centrifuge decelerates during operation.....	43
Centrifuge is inclined.....	43
Centrifuge was moved during run.....	43
Centrifuge, cleaning and care.....	47

Centrifuges

- definition.....	9
Changes in colour.....	51
Changes in structure.....	51
Chemical and biological safety.....	19
Chemical resistance of plastic.....	49
Cleaning agents.....	50
Cleaning the bores of angle rotors.....	48
Cleaning the centrifuge.....	47
Closing the lid.....	18, 26
CO ₂ equivalent.....	55
Communication error.....	45
Condensation.....	25
Condenser dirty.....	43
Condenser, cleaning and care.....	48
Connected load.....	55
Contamination.....	19, 48
Continuous heat resistance.....	50
Continuous run.....	33
Control system.....	30
Copyright.....	10
Corrosion.....	18, 20, 29, 47, 48, 49, 50
Cracking.....	48
Cracks.....	49
Current consumption.....	55
Customer-provided fuses.....	25
Cycle display (Cycles).....	39
Cycles.....	27
Cycles (cycle display).....	39

D

Damage of the surface.....	49
Dangerous goods.....	20
Dangerous materials.....	50
Deceleration curve.....	60
Deceleration curves.....	37
Declaration of conformity.....	10, 67
Declaration of decontamination.....	53
Decontamination agent.....	48, 50
Deformation of tubes.....	51
Density.....	12, 20
Dimensions.....	23

Direct hazard to the life and health.....	16	Improper loading.....	43
Disinfectants.....	50	Infectious substances.....	50
Disinfection of the rotor chamber and accessories	50	Inflammable substances.....	19
Display.....	30	Informal safety instructions.....	17
Disposal.....	54	Initial start-up.....	26
Documentation.....	10	Input fuse.....	12
Drive problem.....	43	Input lock.....	40
E		Inspection by the manufacturer.....	52
Earth conductor check.....	21	Installation of accessories.....	28
EC declaration of conformity.....	10, 67	Installation of angle rotors with a hermetically sealed lid.....	27
EEPROM error.....	45	Installation of rotors and accessories.....	27
Electrical connection.....	55	Installation of the rotor.....	27
Electrical safety.....	18	Installation site.....	25
Emergency lid release.....	44	Intended use.....	9
Equipotential bonding screw.....	21	Interrupting a centrifugation run.....	31
Error correction.....	43	Interrupting a deceleration process.....	31
Error message.....	43	IP code.....	55
Explanation of the symbols and notes.....	16	K	
Explosive substances.....	19	Kinetic energy.....	12
F		L	
Filling quantity (refrigerant).....	55	Layout of the centrifuge.....	11
Fire preventions.....	19	Leaks.....	29, 51
Form for the return of defective units.....	53	Lid cannot be opened.....	43
Freezing-over of the compressor.....	34	Lid error.....	45
Functional and operating elements.....	11	Lid lock device.....	21
Fuses have tripped.....	43	Lid lock has not released.....	43
G		Lid seal sticks.....	43
General Terms and Conditions of Business Relating to Goods and Services of Sartorius.....	9	Linear curves.....	60
Glass breakage.....	50	Load bearing bolts, cleaning and care.....	49
Glass particles.....	50	Loading a program.....	41
Gravitational field.....	55	M	
Grease for load bearing bolts.....	10, 47, 49	Mains power switch off.....	43
H		Mains switch.....	11
Hazard warnings.....	9, 27, 29	Mains voltage.....	18
Highly corrosive substances.....	18	Maintenance.....	47
I		Malfunctions and error correction.....	43
Imbalance.....	28, 29, 49	Manual mode.....	31
Imbalance error.....	45	Manufacturer.....	55
Imbalance monitoring system.....	21	Marking of the unit.....	15
Importance of the operating manual.....	9	Max. kinetic energy.....	55
Important information.....	16	Maximum number of cycles.....	39
		Maximum speed for tubes.....	58
		Measures in the event of hazards and accidents.....	22

Mechanical safety.....	18	Quitting the modification mode.....	31
Mode of operation.....	13	R	
Motor error.....	45	Radioactive substances.....	19, 47
Motor shaft.....	27, 47	Radius.....	14
Multiple carrier.....	29	Range of accessories.....	57
N		Rapid Temp program.....	35
Name plate.....	11, 12, 55	Reaching the maximum number of cycles.....	39
No indication on the display.....	43	Refrigerant.....	55
No power in the mains supply.....	43	Refrigerant data.....	12, 55
Noise level.....	55	Relative centrifugal force (RCF).....	14, 32
Nominal voltage.....	12	Removal of the transport safety device.....	24
Non-greased bolts.....	49	Remove glass particles and metal dust from the rotor chamber.....	50
Notes on safety and hazards.....	9	Responsibility of the operator.....	17
Notes on transport.....	23	Return of centrifuges, spare parts, or accessories.....	53
O		Return of defective units.....	53
Online download of forms.....	53	Risk of electrical shock.....	18
Opening the lid.....	26	Rotor chamber.....	34, 47
Operating personnel.....	17	Rotor monitoring system.....	21
Operating voltage.....	25	Rotor radii.....	58
Operational safety.....	48	Rotor selection.....	36
Overseas shipping.....	23	Rotor tie-down screw.....	27, 49
P		Rotor wrench.....	10, 27
Packaging.....	24	Rotors for microtiter plate formats.....	27
Parameter error.....	45	Rotors, cleaning and care.....	49
Pathogenic substances.....	19, 47, 50	Runtime.....	32
Plastic accessories, cleaning and care.....	49	Runtime as of the set speed.....	33
Potential hazard to the life and health.....	16	S	
Potentially hazardous situation.....	16	Safety area.....	20
Power consumption.....	12, 55	Safety devices.....	21
Power cord is not plugged in.....	43	Safety distance.....	18, 20, 25
Power supply.....	25	Safety instructions.....	9, 27, 29
Preselection of a curve.....	37	Safety instructions for centrifugation.....	20
Pressure (refrigerant).....	55	Safety, chemical and biological.....	19
Pressure marks.....	49	Safety, electrical.....	18
Prevention of accidents.....	9	Safety, mechanical.....	18
Problem description.....	53	Saving a program.....	41
Process error.....	45	Scope of supply.....	10
ProgLock program lock.....	38	Selection, display, and modification of data.....	31
Program "Rapid Temp".....	35	Serial number.....	12, 46, 52
Program lock (ProgLock).....	38	Service.....	52
Protection class.....	25, 55	Service contact.....	46
Q		Service life.....	47
Quick stop.....	31	Service life of rotors and accessories.....	20

Service life of the accessories.....	51	Temperature inside the rotor chamber	21
Service work	52	Temperature monitoring system.....	21
Set-up and connection.....	25	Temperature range.....	55
Short run	34	Temperature value not reached	43
Slushing oil	10	Thermal circuit breaker.....	55
Solvents.....	20, 47, 49	Thermal stress.....	47
Sound signal (buzzer).....	38	Time range.....	55
Spare part enquiries.....	46	Toxic substances	19, 47
Speed	12, 14, 32, 55	Transport safety device.....	24
Speed-gravitational-field-diagram	59	Tubes	29
Speedometer error.....	45	Type	12, 55
Standards and regulations	10	Type of connection	25
Standstill monitoring system.....	21	Type of the centrifuge	46, 52
Starting a centrifugation run.....	31	U	
Sterilisation of the rotor chamber and accessories	50	Ungreased load- bearing bolts	43
Storage and transport	23	Useful volume	
Storage conditions.....	23	- volume that is stated for the tube	29, 58
Storage locations	55	User interface	30
Stress-corrosion		UV radiation.....	25, 47
see		V	
corrosion.....	49	Vents.....	25
Structural changes.....	19	Vessels.....	29
Supply voltage	25	W	
Switching the centrifuge off	42	Warranty and liability	9
Switching the centrifuge on.....	26	Wear	52
System check.....	21	Weight	23
System error	43, 45	Work on the power supply system	18
T		Y	
Table of error codes.....	45	Year of manufacture	12
Technical data	55		
Temperature error.....	45		

Sartorius Lab Instruments GmbH & Co. KG
Weender Landstrasse 94–108
37075 Goettingen, Germany

Phone: +49.551.308.0
Fax: +49.551.308.3289
www.sartorius.com

The information and figures contained in these instructions correspond to the version date specified below.

Sartorius reserves the right to make changes to the technology, features, specifications and design of the equipment without notice.

Copyright notice:

This operating manual, including all of its components, is protected by copyright. Any use beyond the limits of the copyright law is not permitted without our approval. This applies in particular to reprinting, translation and editing irrespective of the type of media used.

© Sartorius Germany

Last updated:
09/2015