

Operating Instructions
Original Operating Instructions

Cubis®

MCA Models
Precision Balances



Contents

1 About these Instructions	6	4.12 Weighing and Print Profiles.....	27
1.1 Scope.....	6	4.13 Tasks and Applications.....	27
1.2 Symbols Used.....	6	4.14 Menu Structure.....	28
1.2.1 Warnings in Operating Instructions.....	6	4.14.1 Main Menu.....	28
1.2.2 Other Symbols.....	6	4.14.2 "Settings" Menu.....	28
1.3 Target Groups.....	7	4.15 Navigating the Menus.....	33
2 Safety Instructions	8	5 Installation	35
2.1 Intended Use.....	8	5.1 Scope of Delivery.....	35
2.1.1 Modifications to the Device.....	8	5.2 Selecting an Installation Site.....	35
2.1.2 Repairs to the Device.....	8	5.3 Unpacking the Device.....	36
2.2 Personnel Qualification.....	8	5.4 Removing the Control Unit.....	36
2.3 Significance of these Instructions.....	9	5.5 Connecting the Ethernet Cable.....	37
2.4 Functionality of the Device.....	9	5.6 Preparing Below-balance Weighing.....	37
2.5 Safety Information on the Device.....	9	5.7 Positioning the Weighing Pan and Associated Components.....	39
2.6 Electrical Equipment.....	9	5.8 Acclimatization.....	39
2.6.1 Damage to the Device's Electrical Equipment.....	9	6 Getting Started	40
2.6.2 Working on the Device's Electrical Equipment.....	9	6.1 Installing the AC Adapter.....	40
2.6.3 Power Supply Unit and Power Supply Cable.....	9	6.2 Connecting the Power Supply.....	40
2.7 Conduct in an Emergency.....	10	6.3 Attaching the Protective Caps.....	41
2.8 Accessories, Consumables, and Spare Parts.....	10	7 System Settings	42
2.9 Glass Breakage.....	10	7.1 Performing System Settings.....	42
3 Device Description	11	7.2 Switching Off the isoCAL Function.....	42
3.1 Device Overview.....	11	7.3 Assigning a Password.....	42
3.2 Weighing Pan and Associated Components.....	12	7.4 Setting Up Device for Network Printer.....	43
3.3 Connections and Components on the Weighing Module.....	12	7.4.1 Selecting Configuration for Network Printing.....	43
3.4 Connections on the Control Unit.....	13	7.4.2 Setting Up Device for Network Printer via Independent Wi-Fi Network.....	43
3.5 Safety Equipment.....	13	7.4.3 Setting Up Device for Network Printer via Company Network.....	44
3.5.1 Protective Caps on the Weighing Module.....	13	7.4.4 Configure Print Profile.....	44
3.6 Conformity-assessed Devices.....	14	7.5 Parameter List.....	45
3.7 Symbols on the Device.....	14	7.5.1 Parameters in the "User Management" Menu.....	45
4 Operating Concept	15	7.5.2 Parameters in the "Access Management" Menu.....	45
4.1 Operating Elements in the Main Menu.....	15	7.5.3 Parameters in the "Timer-Controlled Actions" Menu.....	46
4.2 Operating Elements in Task Management.....	16	7.5.4 Parameters in the "Weighing and Print Profiles/Weighing" Menu.....	47
4.3 Operating Elements in the Weighing Display.....	17	7.5.5 Parameters in the "Weighing and Print Profiles/YDP30, PDF, CSV, PC Direct, or SBI Direct" menu.....	49
4.4 Advanced Operator Guidance.....	18	7.5.6 Parameters in the "Connections/ Connectors" Menu.....	51
4.5 Messages.....	19	7.5.7 Parameters in the "Connections/ Network" Menu.....	52
4.6 Status Center.....	20	7.5.8 Parameters in the "Connections/ Website/Web Services" Menu.....	52
4.7 Keypad.....	21		
4.8 Status Display of the Buttons.....	21		
4.9 Buttons in the Operating Display.....	22		
4.9.1 Buttons for Navigation or Organization in Displays.....	22		
4.9.2 Buttons for Editing or Managing Entries.....	23		
4.9.3 Weighing and Print Function Buttons.....	24		
4.10 Displays in the Operating Display.....	25		
4.11 User Management.....	27		
4.11.1 User Profiles.....	27		
4.11.2 User Login.....	27		

7.5.9	Parameters in the "Connections/ Interfaces/Serial Communication via Network" (Ethernet) Menu	52	9	Cleaning and Maintenance	67
7.5.10	Parameters in the "Connections/ Interfaces/COM-RS232 Interface" Menu	53	9.1	Preparing the Device	67
7.5.11	Parameters in the "Connections/ Interfaces/USB-B Interface" Menu	53	9.2	Cleaning the Device	67
7.5.12	Parameters in the "Connections/ SBI Protocol" Menu	54	9.3	Assembling and Connecting the Device	68
7.5.13	Parameters in the "Connections/ Climate Module" Menu	54	9.4	Maintenance Schedule	68
7.5.14	Parameters in the "Connections/ Connected Devices/Motion Sensor" (Only for Connected Motion Sensors)	54	9.5	Performing a Software Update	68
7.5.15	Parameters in the "Device Settings/ Date and Time" Menu	55	9.6	Performing a QAPP Center Update	69
7.5.16	Parameters in the "Device Settings/ Safe Weighing" Menu	55	10	Malfunctions	70
7.5.17	Parameters in the "Device Settings/ minUSP" Menu	56	10.1	Warning Messages	70
7.5.18	Parameters in the "Device Settings/ Device ID" Menu	56	10.2	Troubleshooting	70
7.5.19	Parameters in the "Device Settings/ Electronic Signature" Menu	56	11	Decommissioning	71
7.5.20	Parameters in the "Device Settings/ Start-up Behavior" Menu	56	11.1	Decommissioning the Device	71
7.5.21	Parameters in the "Device Settings/ Display Properties" Menu	57	12	Transport	71
7.5.22	Parameters in the "Device Settings/ Sound (Loudspeaker)" Menu	57	12.1	Transporting the Device	71
7.5.23	Parameters in the "Device Maintenance" Menu	57	13	Storage and Shipping	72
8	Operation	58	13.1	Storage	72
8.1	Switching the Device On and Off	58	13.2	Returning Device and Parts	72
8.2	Logging Users In and Out	58	14	Disposal	73
8.3	Leveling the Device	59	14.1	Information on Decontamination	73
8.3.1	Level Device with Motorized Leveling Feet	59	14.2	Disposing of Device and Parts	73
8.4	Activating Applications and Adding a Task	59	14.2.1	Information on Disposal	73
8.4.1	Activating Applications	59	14.2.2	Disposal	73
8.4.2	Adding an Application to a Task	60	15	Technical Data	74
8.5	Adding Weighing and Print Profiles to a Task	60	15.1	Dimensions and Weight	74
8.6	Preparing Weighings	60	15.2	Ambient Conditions	74
8.7	Weighing	61	15.2.1	Installation Site	74
8.8	Overview of Calibration, Adjustment, and Linearization	61	15.2.2	Ambient Temperature for the isoCAL Function	75
8.9	Adjusting with the isoCAL Function	62	15.2.3	Protection Class	75
8.10	Internally Calibrating and Adjusting the Device	63	15.3	Power Supply	75
8.11	Weighing and Printing with ID Marking	63	15.3.1	Device	75
8.11.1	Saving Values for Printouts	63	15.3.2	Power Supply Unit	75
8.11.2	Marking Saved Values as Invalid	64	15.3.3	Safety of Electrical Equipment	76
8.11.3	Marking Saved Values as Valid	64	15.3.4	Electromagnetic Compatibility	76
8.11.4	Printing Saved Values	64	15.4	Materials	76
8.11.5	Exiting the Task	64	15.5	Integrated Clock	76
8.12	Viewing the Data Storage Device	65	15.6	Backup Battery	76
8.13	Running Applications (Examples)	65	15.7	Metrological Data	77
8.13.1	Executing the "Unit Change" Function	65	15.7.1	Models MCA14202S MCA14202P MCA10202S MCA8202S	77
8.13.2	Running the "Statistics" Application	66	15.7.2	Models MCA6202S MCA6202P MCA4202S MCA2202S	78
			15.7.3	Models MCA1202S MCA12201S MCA8201S MCA5201S	79

15.8	Recommended Calibration Weight	80
15.9	isoCAL Function	80
15.9.1	Models MCA14202S MCA14202P MCA10202S	80
15.9.2	Models MCA8202S MCA6202S MCA6202P MCA4202S MCA2202S MCA1202S	80
15.9.3	Models MCA12201S MCA8201S MCA5201S	80
15.10	Data Storage Device	81
15.11	Interfaces	81
15.11.1	Specifications for the COM-RS232 Interface	81
15.11.2	Specifications for the USB-A Interface	81
15.11.3	Specifications for the USB-B Interface	81
16	Accessories	82
16.1	Accessories	82
16.1.1	Printers and Communication	82
16.1.2	Displays and Input/Output Elements	82
16.1.3	Special Applications	83
16.1.4	Weighing Tables	83
16.1.5	Weighing Accessories	83
17	Sartorius Service	84
18	Conformity Documents	84
18.1	EU Declaration of Conformity	84
18.2	Certificate of Compliance	86
18.3	FCC Supplier's Declaration of Conformity	88

1 About these Instructions

1.1 Scope

These instructions are part of the device. These instructions apply to the device in the following versions:

Device	Model
Cubis® Precision Balance	MCA10202S-... MCA1202S-... MCA12201S-... MCA14202P-... MCA14202S-... MCA2202S-... MCA4202S-... MCA5201S-... MCA6202P-... MCA6202S-... MCA8201S-... MCA8202S-...
Software Version	Version, at least
Package release	09-03-02.02.14
QAPP-Center Version	09-06-04.00.06

1.2 Symbols Used

1.2.1 Warnings in Operating Instructions

WARNING

Denotes a danger with the risk that death or severe injury may result if it is **not** avoided.

CAUTION

Denotes a hazard that may result in moderate or minor injury if it is **not** avoided.

NOTICE

Denotes a danger with the risk that property damage may result if it is **not** avoided.

1.2.2 Other Symbols

- ▶ Required action: Describes actions which must be carried out.
- ▷ Result: Describes the result of the actions carried out.
- [] Text inside brackets refers to control and display items.
- [] Text inside brackets indicates status, warning, and error messages.
-  Indicates information for legal metrology for conformity-assessed (verified) devices. Conformity-assessed devices are also referred to as "verified" in these instructions.

Figures on the Operating Display

The figures on the operating display of the device may deviate from those in these instructions.

1.3 Target Groups

These instructions are addressed to the following target groups. The target groups must possess the specified knowledge.

Target group	Knowledge and responsibilities
---------------------	---------------------------------------

User	The user is familiar with the operation of the device and the associated work processes. They understand the hazards which may arise when working with the device and know how to prevent them. They have been trained in the operation of the device. The training is carried out by the operating engineer/laboratory manager or the operator of the device.
Operator	The operator of the device is responsible for compliance with safety requirements and workplace safety regulations. The operator must ensure that all persons who work with the device have access to the relevant information and are trained in working with the device.

2 Safety Instructions

2.1 Intended Use

The device is a high-resolution balance, which can be used in laboratories. The device was developed to accurately determine the mass of materials in liquid, paste, powder, or solid form.

Appropriate containers must be used for loading each type of material. The device can be used in stand-alone operation or can be operated on a PC.

The device is exclusively designed for use in accordance with these instructions. Any further use beyond this is considered **improper**.

If the device is **not** used properly: The protective systems of the device may be impaired. This can lead to unforeseeable personal injury or property damage.

Operating Conditions for the Device

Do **not** use the device in potentially explosive environments. Only use the device indoors.

The device may only be used with the equipment and under the operating conditions described in the Technical Data section of these instructions.

2.1.1 Modifications to the Device

If the device is modified, for example by attaching extra components: Device safety may be affected, or the device may cease to be compliant.

If you have any queries regarding modifications to the device, contact Sartorius.

2.1.2 Repairs to the Device

Device repairs may only be carried out by persons with appropriate specialized knowledge of the device. If the device is **not** repaired by a specialist: The safety of the device may be impaired or the quality marks may lose their validity.

We recommend that any repair work, even that not covered by the warranty, is carried out by Sartorius Service or after consulting with Sartorius Service.

2.2 Personnel Qualification

If people who do **not** have sufficient knowledge on the safe handling of the device carry out work on the device: Those people may injure themselves or other people nearby.

- ▶ Ensure that all individuals working on the device possess the necessary knowledge and qualifications (see Chapter "1.3 Target Groups", page 7).
- ▶ If a particular qualification is required for the actions described: Have these activities carried out by the required target group.
- ▶ If **no** qualification is required for the actions described: Have these activities carried out by the "user" target group.

2.3 Significance of these Instructions

Failure to follow the instructions in this manual can have serious consequences, e.g., exposure of individuals to electrical, mechanical, or chemical hazards.

- ▶ Before working with the device: Read the instructions carefully and completely.
- ▶ If these instructions are lost, request a replacement or download the latest version from the Sartorius website (www.sartorius.com).
- ▶ Ensure that the information contained in these instructions is available to all individuals working on the device.

2.4 Functionality of the Device

A damaged device or worn parts may lead to malfunctions or cause hazards which are difficult to recognize.

- ▶ Only operate the device when it is safe and in perfect working order.
- ▶ In the event of damage to the housing, disconnect the device from the power supply and prevent it from being restarted.
- ▶ Do not open the device housing. Have any damage repaired immediately by Sartorius Service.

2.5 Safety Information on the Device

Symbols, e.g. warnings, safety stickers, are safety information for the handling of the device. Missing safety information may lead to serious injuries.

- ▶ Do **not** conceal, remove, or modify the symbols.
- ▶ Replace the symbols if they become illegible.

2.6 Electrical Equipment

2.6.1 Damage to the Device's Electrical Equipment

Damage to the electrical equipment of the device, e.g. damage to the insulation, can be life-threatening. Contact with parts under voltage represents a direct danger to life.

- ▶ If the device's electrical equipment is defective, disconnect the device from the power supply and contact Sartorius Service.
- ▶ Keep live parts away from moisture. Moisture can cause short-circuits.

2.6.2 Working on the Device's Electrical Equipment

Only Sartorius Service personnel may work on or modify the electrical equipment of the device. The device may only be opened by Sartorius Service personnel.

2.6.3 Power Supply Unit and Power Supply Cable

Serious injury can result, e.g. from electric shocks, if an unsuitable and inadequately dimensioned power supply cable or unsuitable AC adapter is used.

- ▶ Only use the original power supply cable and AC adapter.
- ▶ If the AC adapter or power supply cable must be replaced: Contact Sartorius Service. Do **not** repair or modify the power supply unit or power supply cables.

2.7 Conduct in an Emergency

If there is immediate danger of personal injury or if there is a risk of damage to the device, e.g., due to malfunctions or dangerous situations, the device must be immediately taken out of operation.

- ▶ Disconnect the device from the power supply by disconnecting the power supply cable.
- ▶ Malfunctions should be remedied by Sartorius Service.

2.8 Accessories, Consumables, and Spare Parts

Unsuitable accessories, consumables, and spare parts can adversely affect functionality and safety, and have the following consequences:

- Risk of injury to persons
 - Damage to the device
 - Device malfunctions
 - Device failure
- ▶ Only use approved accessories and spare parts supplied by Sartorius.
 - ▶ Only use accessories, consumables, and spare parts that are in proper working order.

2.9 Glass Breakage

Glass components can break if they fall or are handled incorrectly. Glass fragments can cause cuts.

- ▶ Only lift the device by its base.
- ▶ When lifting and transporting, ensure that **no** personnel or objects are in the way.
- ▶ Only operate the operating display with your fingers. Do **not** use pointed or sharp objects.

3 Device Description

3.1 Device Overview

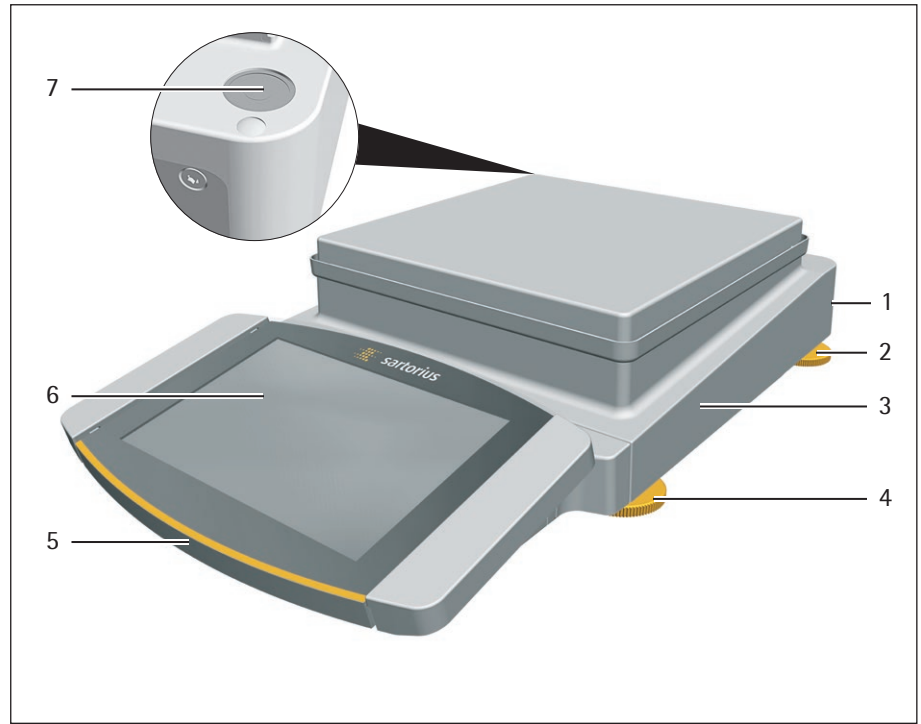

Fig. 1: Precision balance (example)

Pos.	Name	Description
1	Manufacturer's ID label	Not depicted
2	Leveling foot	Depends on model: Not adjustable, is screwed in for leveling.
3	Weighing module	
4	Leveling foot	Motorically or manually adjustable
5	Control unit	
6	Operating display	Touchscreen
7	Level	

3.2 Weighing Pan and Associated Components

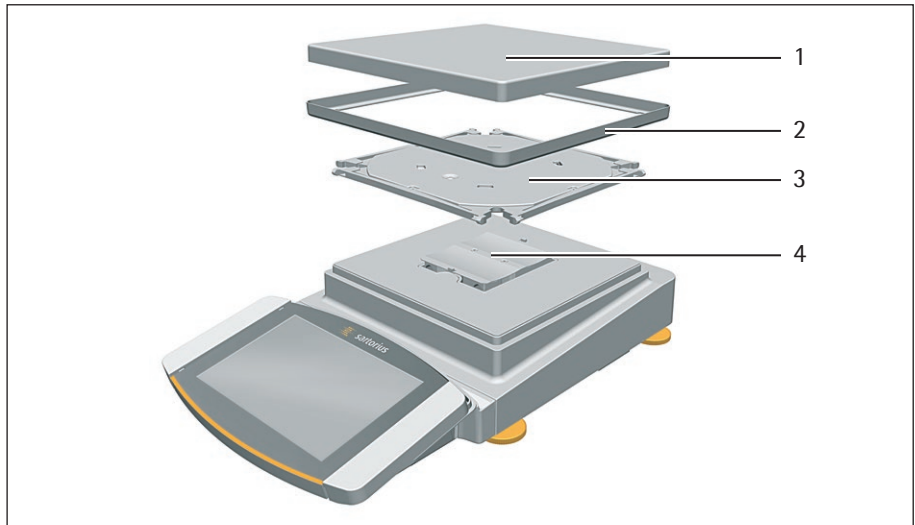

Fig. 2: Precision balance (example)

Pos.	Name
1	Weighing pan
2	Shield disk
3	Pan support
4	Pan retainer

3.3 Connections and Components on the Weighing Module

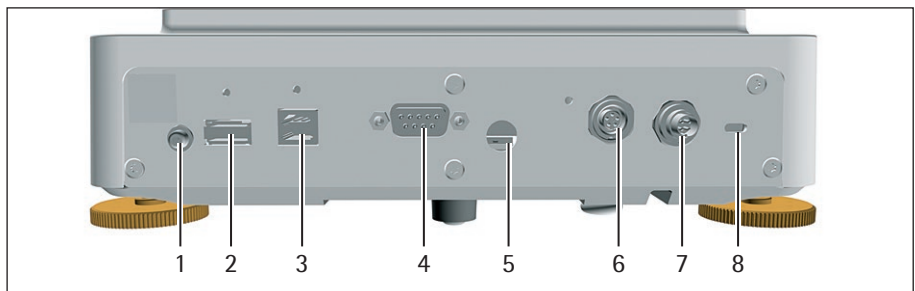

Fig. 3: Connections to the weighing module (example)

Pos.	Name	Description
1	On key	
2	USB-A connection	For USB accessories, e.g. printers, USB mass storage devices, barcode scanners
3	USB-B connection	For connection to a PC
4	COM-RS232 connection	9-pin, for connection to a PC or PLC
5	Access switch	Protects the device from changes to the device settings. Is sealed for conformity-assessed devices.
6	Peripheral connection	For connecting Sartorius accessories
7	Power supply	For connection to the power supply
8	Slot	For attaching a "Kensington" anti-theft device

3.4 Connections on the Control Unit

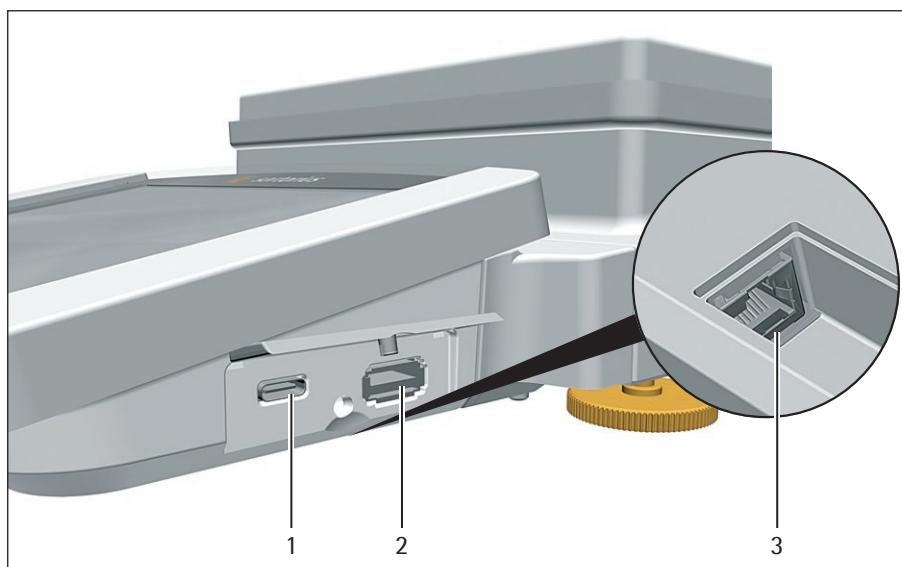

Fig. 4: Connections on the control unit (example)

Pos.	Name	Description
1	USB-C connection	For USB mass storage
2	USB-A connection	For USB accessories, e.g. printers, USB mass storage devices, barcode scanners
3	Ethernet connection	For connecting an Ethernet cable

3.5 Safety Equipment

3.5.1 Protective Caps on the Weighing Module

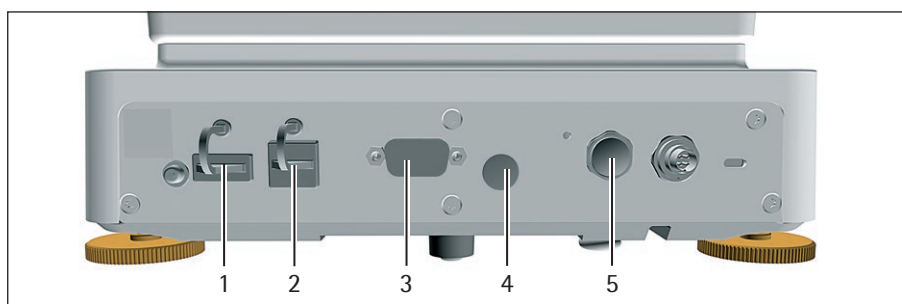

Fig. 5: Connections to the Weighing Module

Pos.	Name	Description
1	Protective cap for USB-A connection	Plastic attachment hood, fastened to the device.
2	Protective cap for USB-B connection	Plastic attachment hood, fastened to the device.
3	Protective cap for COM-RS232 connection	Removable plastic sealing cap.
4	Protective cap for access switch	Removable plastic sealing cap.
5	Protective cap for peripheral connection	Removable plastic sealing cap.

3.6 Conformity-assessed Devices

Some settings of conformity-assessed models are protected against user changes, e.g. "external calibration" for devices in accuracy class II. This measure is intended to ensure the suitability of the devices for use in legal metrology.

3.7 Symbols on the Device



Fig. 6: ID label on the device (example)

Pos.	Designation	Description
1	Manufacturer's ID label	Displays the metrological data of the device. Conformity-assessed models only

4 Operating Concept

4.1 Operating Elements in the Main Menu

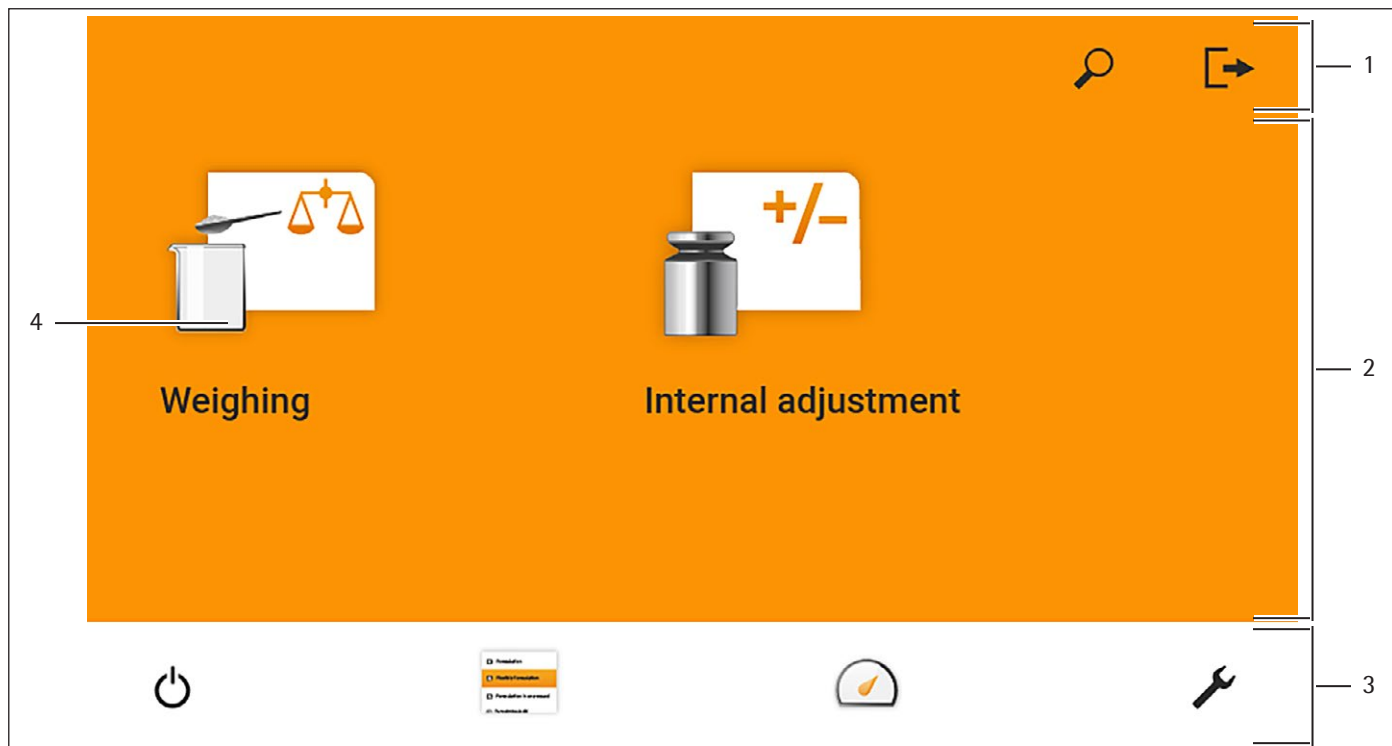

Fig. 1: Operating elements in the main menu (example)

Pos.	Name	Description
1	Navigation and function bar	<ul style="list-style-type: none"> – Enables navigation and searching in menus and lists. – In the "Settings" Menu: Displays the name of the menu.
2	Available tasks	Displays all tasks available for the active user.
3	Function bar	Displays available submenus and operating functions for the current display and current user.
4	Task	Starts the described task.

4.2 Operating Elements in Task Management

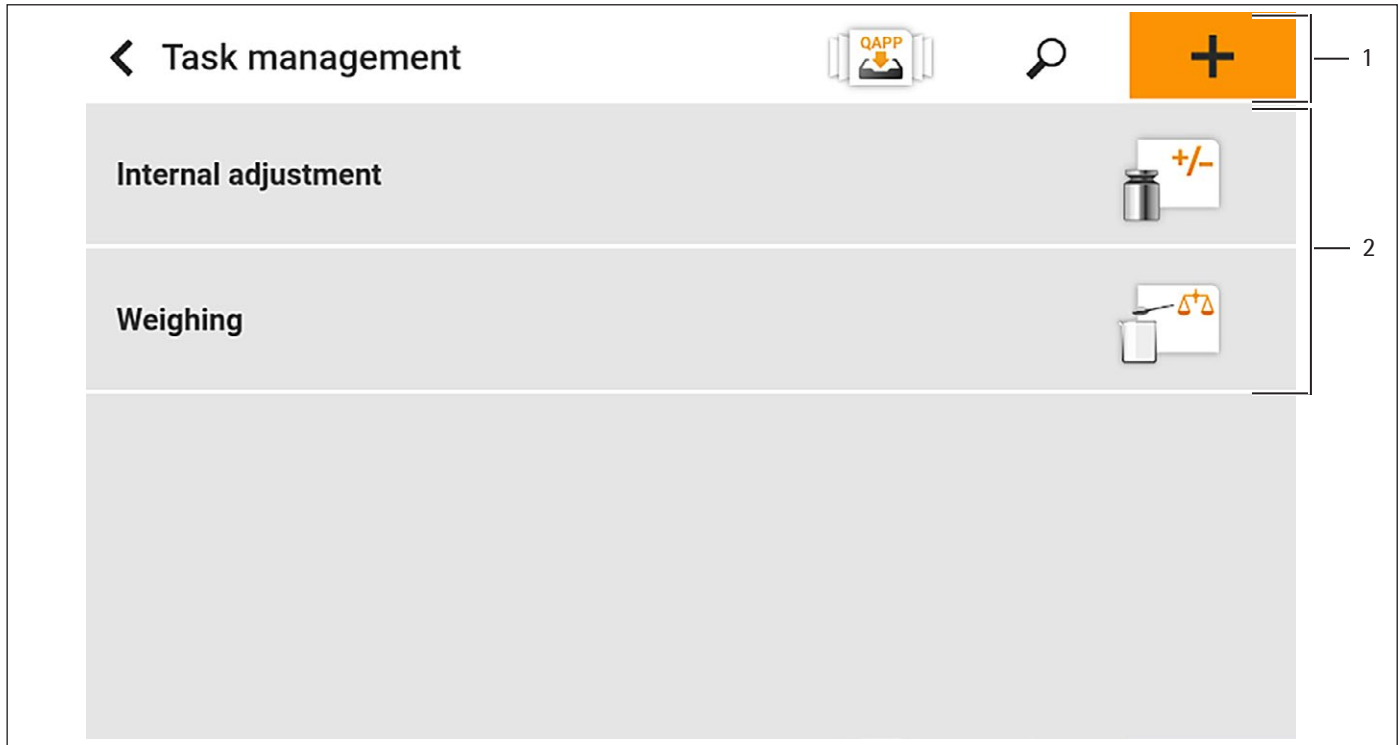

Fig. 2: Operating elements in Task Management (example)

Pos.	Name	Description
1	Navigation and function bar	<ul style="list-style-type: none"> – Enables navigation and searching in menus and lists. – Enables the addition of tasks. – Opens the QAPP center. – Displays the name of the menu.
2	Available tasks	<ul style="list-style-type: none"> – Displays all available tasks. – Opens a summary of the properties for the displayed task.

4.3 Operating Elements in the Weighing Display

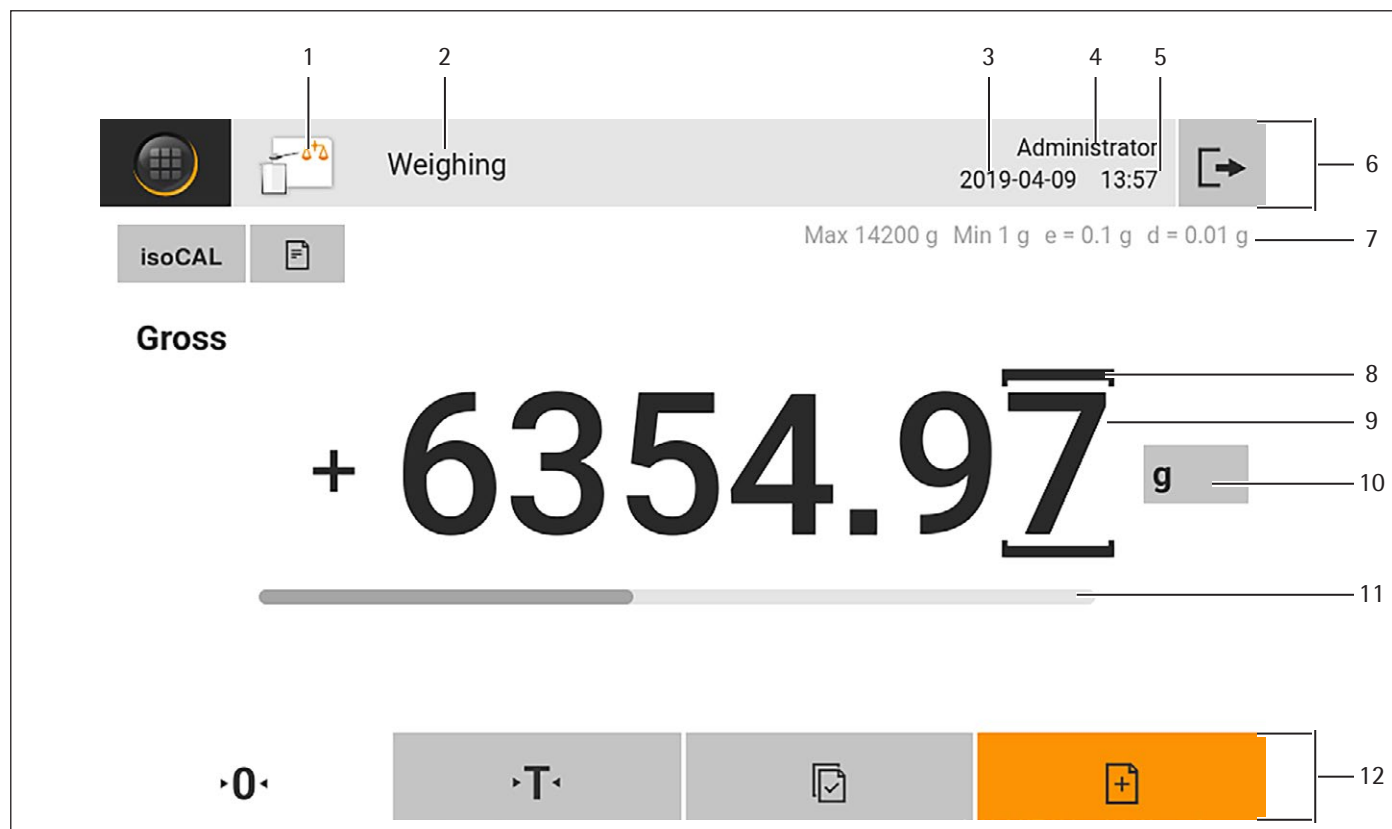

Fig. 3: Weighing display (example)

Pos.	Name	Description
1	Application symbol	Displays the symbol for the active application.
2	Task name	Displays the name of the active task.
3	Date display	Displays the current date.
4	User name	Displays the name of the active user profile.
5	Time display	Displays the current time.
6	Navigation bar	Enables navigation in menus.
7	Metrological data	
8	Labeled points	Labels the differentiated points.
9	Weight value display	In the selected unit and resolution
10	Weighing unit	Displays the selected unit, e.g. grams, [g]. Enables the unit and resolution to be selected.
11	Bar graph	Displays the measured value as a percentage of weighing capacity utilization.
12	Function bar	Displays available operating functions for the current display.

4.4 Advanced Operator Guidance

Advanced applications have advanced operator guidance.

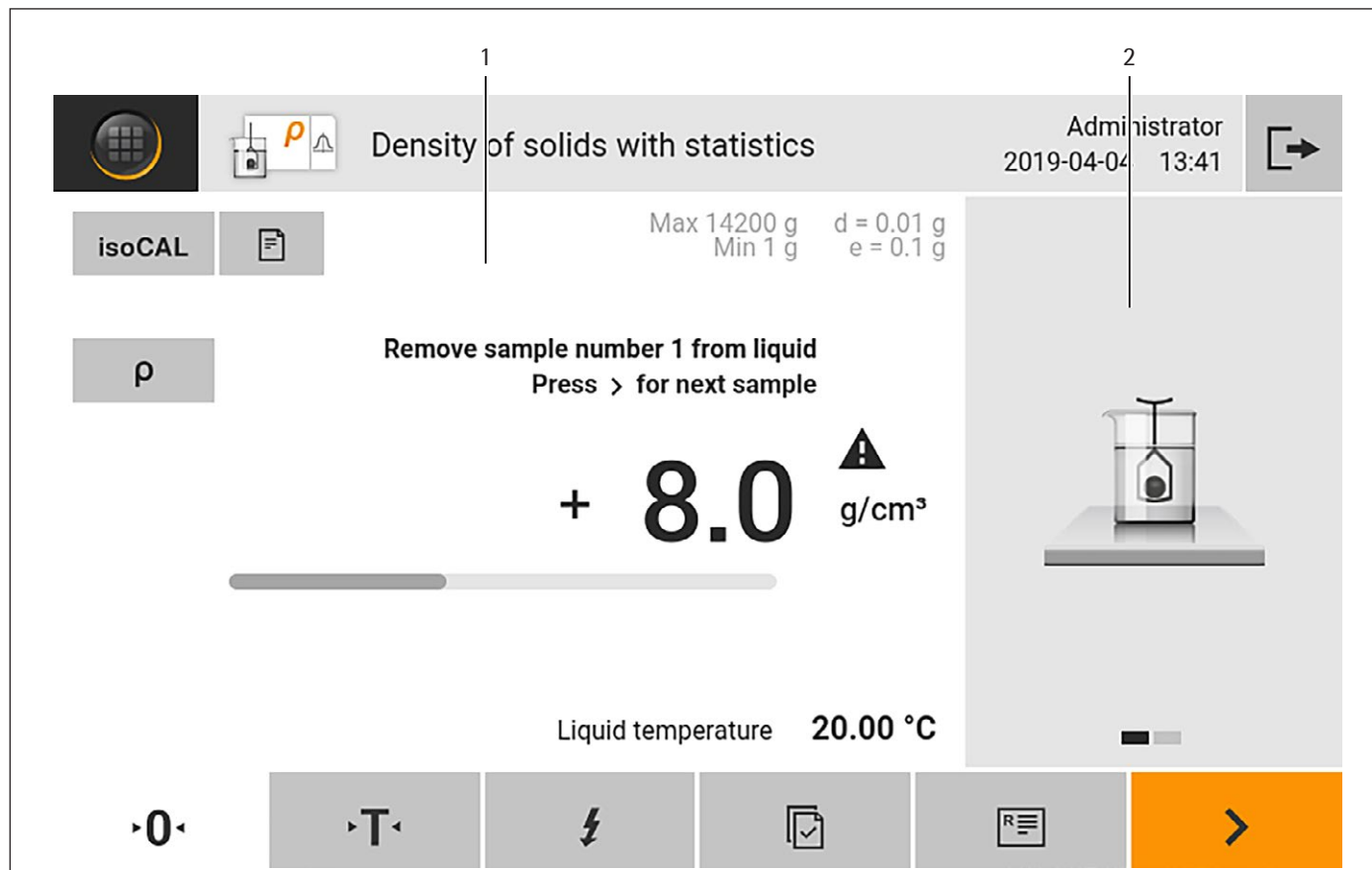

Fig. 4: Advanced operator guidance (example)

Pos.	Name	Description
1	Weighing display with operator guidance	
2	Advanced operator guidance	Guides the user through the active task. Includes 2 or 3 convertible displays depending on the selected application: <ul style="list-style-type: none"> – First display: Shows the step currently being carried out as a graphic display. – Second display: Shows the current parameters for the task. – Third display, only for applications with statistics function: Represents statistical information as a curve.

4.5 Messages

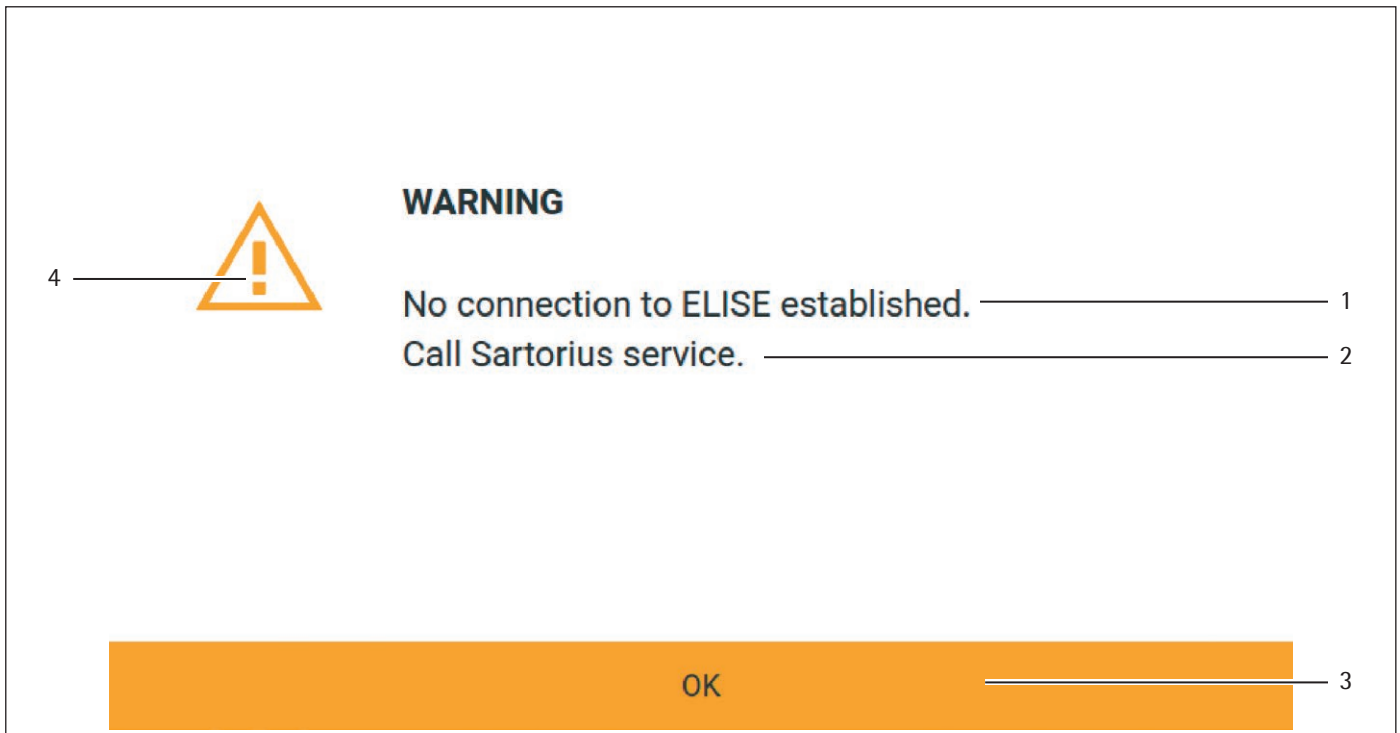

Fig. 5: Error message (example)

Pos.	Name	Description
1	Description	Specifies the cause.
2	Remedy	Specifies the measures necessary to eliminate the cause of the message.
3	Confirm	Confirms and closes the message.
4	Message type	Indicates that the message is a status message, warning message, or an error message.

4.6 Status Center

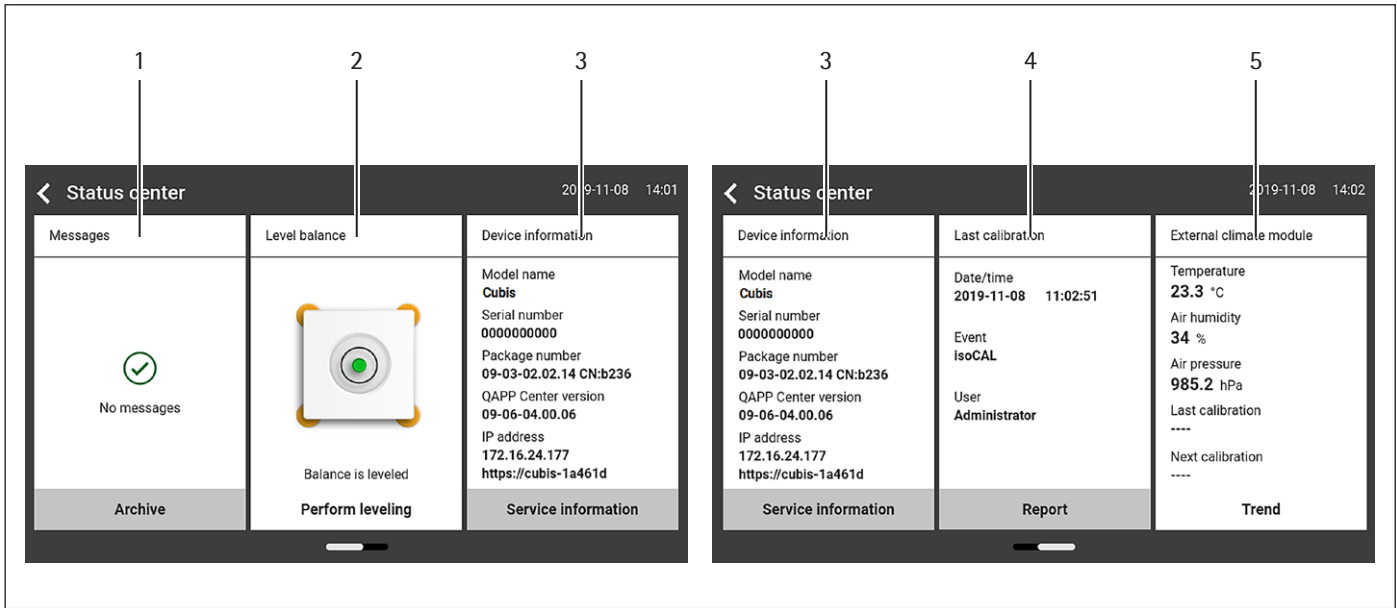

Fig. 6: Status Center (example)

Pos.	Name	Description
1	Messages	Displays information, warning, and error messages.
2	Leveling status	Displays the status of the level.
3	Status for the device	Displays the general device information.
4	Calibration and adjustment report	Displays the data for the last adjustment and calibration.
5	Climate data status	Displays the data from the optional climate module.

4.7 Keypad

The keypad is used for entering values in entry fields. If an entry field is activated: The alphanumeric keypad or numerical keypad appears.

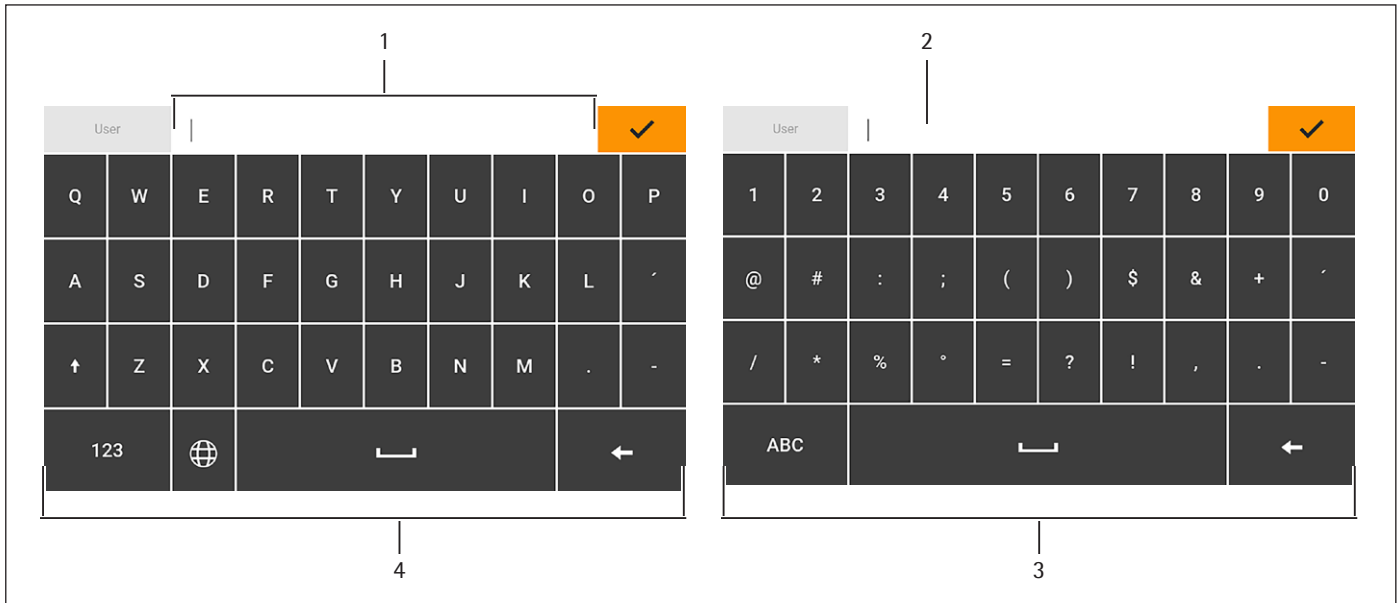





Fig. 7: Alphanumeric keypad and numerical keypad (example)

Pos.	Name	Description
1	Entry field	
2	Input assistance	Indicates which values must be entered in the input field, e.g. numbers only.
3	Numeric keypad	
4	Alphanumeric keypad	







4.8 Status Display of the Buttons

Symbol	Name	Description
	Predominant button	Indicates that the function must be executed. The button is color-highlighted.
	Secondary button	Indicates that the function can be executed. The button is color-highlighted.
	Inactive button	Indicates that the function currently cannot be executed. The button is grayed out.







4.9 Buttons in the Operating Display







4.9.1 Buttons for Navigation or Organization in Displays

Symbol	Name	Description
	[Menu] button	Quits the active task and opens the main menu.
	[Back] button	<ul style="list-style-type: none"> – Returns to the previous display. – In the main menu: Accesses the last-performed task.
	[Search] button	Displays options for browsing tasks and list elements.
	[Filter] button	Displays options for filtering tasks and list elements.
	[Sort] button	Displays options for sorting tasks and list elements.
	[Standby] button	Switches the operating display to standby mode.
	[Task Management] button	Opens Task Management.
	[Status Center] button	Opens the Status Center.
	[Setup] button	Opens the "Settings" menu.
	[User Logout] button	Logs the currently active user out and accesses the login display.
	[User Login] button	Accesses the login display.
	[Next] button	Accesses the next display, e.g. the next processing step for a wizard.
	[Active Search] button	Displays an active search for tasks or list elements.
	[Active Filter] button	Displays an active filter for tasks or list elements.
	[Sort Ascending] button	Sorts tasks or list elements in ascending order.
	[Sort Descending] button	Sorts tasks or list elements in descending order.
	[10 Positions Forward] button	Jumps forwards 10 positions in tasks or list elements.
	[10 Positions Right] button	Jumps 10 positions to the right in tasks or list elements.



Symbol	Name	Description
Service Information	[Service Information] button	Opens the "Settings" / "Device Settings" / "Device Information" / "Service" menu.
Archive	[Status Archive] button	Opens an overview of all status messages, warning messages, and error messages.
Perform leveling	[Leveling] button	Opens the Leveling Wizard.
	[Warning] button	Opens the list of current warning messages.
	[Error] button	Opens the list of current error messages.
	[Info] button	<ul style="list-style-type: none"> – Opens a display with additional information using the current menu. – In the Status Center: Opens the list of current status messages.
	[QAPP Center] button	Opens the QAPP center.
	[Details] button	Shows additional information about an element.
	[Display Image] button	Displays available images or videos.
	[Close Menu] button	Closes the menu.









4.9.2 Buttons for Editing or Managing Entries

Symbol	Name	Description
	[New] button	<ul style="list-style-type: none"> – In Task Management: Starts the wizard for creating a new task. – In Profile Management: Starts the wizard for creating a new weighing or print profile.
	[Activate QAPP] button	Opens the display for activating an application.
	[OK] button	Saves a selection or entry.
	[More] button	Shows the keypad for entering a user-defined value.
	[Select All] button	Selects all elements of a list.
	[Deselect All] button	Deselects the selection for all elements of a list.
	[Cancel] button	<ul style="list-style-type: none"> – Cancels the current process without saving the changed settings or values. – In the display for editing the print memory: Marks the selected value as invalid.



Symbol	Name	Description
	[Edit] button	Accesses the Adjustment Wizard for editing the displayed element, e.g. for setting the parameters for a task.
	[Delete] button	Deletes the selected element.
	[User Activated] button	Logs in a deactivated user.
	[User Deactivated] button	Logs out the currently logged-in user.
License	[License] button	Opens the entry field for the license key for activating a QAPP package or application.
	[Keypad] button	Shows the keypad.
	[Select Character Set] button	Accesses the Adjustment Wizard for selecting a character set.
▶ PT1	[Show Preset Tare 1 Function] button	Shows the preset tare 1 function.
◀ PT1	[Hide Preset Tare 1 Function] button	Hides the preset tare 1 function.
	[Lock] button	Opens the entry field to change the password for the active user.







4.9.3 Weighing and Print Function Buttons

Symbol	Name	Description
	[Leveling] button	Opens the Leveling Wizard.
isoCAL	[isoCAL] button	Starts the isoCAL function.
Prc	[Result] button	Toggles between the result and weight value display for the current application, e.g. weighing in percent.
▶ 0 ◀	[Zero] button	Starts zeroing.
▶ T ◀	[Tare] button	Starts taring.
▶ T1 ◀	[Tare 1]	Stores the current weight value in the tare 1 memory.
Tare 1 0.00 g	[Enter Tare 1]	Opens an entry field for manually entering the tare 1 value.
T1 	[Delete Tare 1]	Deletes the tare 1 memory.
	[Start] button	Starts the selected application.

Symbol	Name	Description
	[Quit] button	Quits the active application and opens the Print Memory display.
	[Confirm] button	Confirms the current display and initializes the next step.
	[Save] button	Saves the weight value and sends it to the print memory.
	[Print memory] button	Opens the Print Memory display.
	[Print] button	<ul style="list-style-type: none"> – If the Print Memory is displayed: Exports the saved print orders via the integrated data interfaces.
g	[Unit change] button	<ul style="list-style-type: none"> – Toggles between the weight units and the resolution. – Accesses the "Unit change" function menu.
	[Restart] button	If an application is active: Deletes the saved values and restarts the application.
	[Report] button	If an application is active, e.g. density determination: Displays a report about the progress of the application.
	[Result report] button	If an application is active, e.g. density determination: Displays a report about the result of the application.

4.10 Displays in the Operating Display

Symbol	Name	Description
	[Leveling] display	Indicates that the device is not leveled.
	[Print memory] display	Indicates that the elements are located in the print memory.
g	[Unit symbol] display	Indicates the set weight unit, e.g. [g] for "grams".
Gross	[Result] display	Indicates whether the weight value being displayed is a gross value or the result of an application.
	[Invalid weight value] display	<ul style="list-style-type: none"> – Together with the unit, the display shows the calculated weight value of an application, e.g. for the "Totalizing" application. The displayed weight value is less than the specified minimum weight. – For conformity-assessed devices without unit display: <ul style="list-style-type: none"> – Negative gross value – The device has not yet reached the necessary operating temperature to accurately determine the weight. – The device is not leveled. – The device requires the isoCAL function to be executed.

Symbol	Name	Description
	[Sign] display	Indicates whether the value being displayed is positive or negative.
	[Current page] display	<ul style="list-style-type: none"> – Indicates that the current display is a multi-page display. – Indicates which page of a multi-page display is being displayed currently.
	[Copy] button	Indicates that data are being copied.
	[Selection] display	Indicates that an entry is selected in a list.
	[Target value] display	Displays the target value in the bar graph display.
	[Factory mode] display	Indicates that the device is being operated in the factory default mode.

4.11 User Management

4.11.1 User Profiles

In the factory, 4 user profiles are created for the device. One role is assigned to each user profile. Each role has rights to operate the device. The rights assigned to each role depend on which device functions the user has to use. User profiles can be adapted.

Additional user profiles, roles, and rights may be activated in the QAPP center.

4.11.2 User Login

The user must log in to the login display with a user profile. Various setting options and tasks are displayed in the operating display depending on the user profile and role.

4.12 Weighing and Print Profiles

Weighing and print profiles can be created. These profiles can be assigned to a task.

Preset profiles can be used in a task. The preset profiles can be adjusted individually to the application and saved in new profiles for weighing and printing.

4.13 Tasks and Applications

Device functions such as weighing or calibration and adjustment are carried out using tasks. Applications must be assigned to a task.

A task is visible to all users who are approved for this task.

The device is supplied with some freely accessible applications in the "Essentials" QAPP package which can be used to carry out the most important functions.

Additional applications can be unlocked via the QAPP center for a fee.

4.14 Menu Structure

4.14.1 Main Menu

► Navigating in menus (see Chapter 4.15, page 33).

Level 1	Level 2	Level 3	Description
Task management			Displays all available tasks. Opens a summary of the properties for the displayed task.
	QAPP center		Display the available QAPP packages.
Status Center			Display information on the device status, e.g. level status.
Settings	General device information		
	User Management		
	Access Management		Only available if the "User Management" extension has been licensed in the QAPP center.
	Timer-controlled actions		
	Weighing and Print Profiles		
	Connections		
	Device Settings		
	Device Maintenance		

4.14.2 "Settings" Menu

Depending on the approved applications, the device may display additional menus.

► Navigating in menus (see Chapter 4.15, page 33).

Level 1	Level 2	Level 3	Description
Device information	General device information	Manufacturer	Display information about the device's manufacturer.
		Model name	Display the device's model name.
		Serial number	Display the device's serial number.
		Package version	Display the version of the device firmware with check number.
		QAPP Center Version	Display the version of the QAPP center.
		IP address	Display the IP address of the device.
		Host name	Display the device's host name in a network.
		MAC address	Display the MAC address of the device.
		Certification body SHA1 fingerprint	Display the certification body's SHA1 fingerprint.
		HTTPS certificate SHA1 fingerprint	Display the HTTPS certificate's SHA1 fingerprint.
		Service	Service contact
	Telephone number		Display the telephone number for Sartorius Service.

Level 1	Level 2	Level 3	Description
		E-mail	Display the e-mail address for Sartorius Service.
		Hotline	Display the technical hotline for Sartorius Service.
		Contract	Display the responsible contact for maintenance measures.
		Next scheduled maintenance	Display the date for the next scheduled maintenance.
		Warning date	Display the warning date for maintenance.
		Maintenance cycle	Display the maintenance cycle.
		Website	Display the website for Sartorius Service.
		Device qualification	Display the qualification date.
	View data storage device		Display, filter, or browse the contents of the data storage device.
	View audit trail		If an audit trail license has been purchased: Display, filter, or browse the contents of the audit trail memory.
	Diagnosics information	Package version	Display the version of the device firmware with check number.
		Balance version	Display the version of the BAC processor.
		Application version	Display the version of the APC processor.
		MCU version	Display the version of the MCU processor.
		Draft shield version	Display the version of the WPC processor.
	Software licenses		The list of all open source software modules used.
User Management	4 standard user profiles		Display or edit the standard user profiles. If the "User Management" extension has been configured in the QAPP center: Display or edit additional user profiles, roles, and rules.
Access Management	Role management	3 user profiles	If the "User Management" extension has been configured in the QAPP center: Define the role names, description, and rights for the user profile.
	Rules		If the "User Management" extension has been configured in the QAPP center: Define the rules for failed attempts at password entry.
	Local password rules		If the "User Management" extension has been configured in the QAPP center: Define the permissible characters, length, and validity time for the password.
	LDAP server configuration		If the "User Management" extension has been configured in the QAPP center: Configure the data for device communication with an LDAP server.

Level 1	Level 2	Level 3	Description
Timer-controlled actions	Start task		Display, edit or delete properties for starting the task.
	Display message		Display, edit or delete the message name and content.
	Standby mode		Display, edit or delete execution of the action for standby mode.
	Wake-up from standby		Display, edit or delete the execution time and name for wake-up from standby.
	Switch-off		Display, edit, or delete the execution time for the action.
	Automatic backup		Display, edit, or delete the backup name and properties.
	Export audit trail		Display and select options for export.
Weighing and Print Profiles	Weighing	List of available weighing profiles	Display all available weighing profiles. Edit, create or delete the weighing profiles.
	YDP30	List of available print profiles	Display all available print profiles. Edit, create or delete the print profiles.
	PDF	PDF document on USB	Display all available print profiles. Edit, create or delete the print profiles.
	CSV	Spreadsheet (CSV) on USB	Display all available print profiles. Edit, create or delete the print profiles.
	PC direct	PC direct (USB keyboard emulation)	Display all available PC direct profiles. Edit, create or delete the PC direct profiles.
	SBI direct	SBI print	Display all available SBI direct profiles. Edit, create or delete the SBI direct profiles.
Connections	Connectors	USB	Define the settings for the connected USB stick.
		YDP30-NET	Enter the IP/host address and the parameters for the printer.
		FTP	If this extension has been configured in the QAPP center: The connection to the FTP or FTPS servers facilitates file transfer using the FTP or FTPS protocol.
		FTPS	
		Network printer	Enter the IP/host address and the protocol for the network printer.
		SMB	If the "Windows File Server" extension has been configured in the QAPP center: The connection to the Windows file server facilitates file transfer using the Server Message Block (SMB protocol).
	Network	General settings	Define the device host name.
		Ethernet	Display and edit settings for the device's Ethernet connection.
		Wi-Fi	Define and edit settings for the device's Wi-Fi connection.
	Website / web services	Website access	Determines the settings for the display of the website for the device.
		Remote access	Define the settings for controlling the device remotely.
		Web service password	Define the password for the web services.

Level 1	Level 2	Level 3	Description
	Interfaces	Serial communication over network	Display and edit the profile for the Ethernet connection.
		COM-RS232 interface	Display and edit the profile for the RS232 connection.
		USB-B interface	Display and edit the profile for the USB-B connection.
	SBI protocol	Format	Configure the settings for the data output and data output format.
		Output	Define whether the output takes place with or without stability.
		Automatic data output	Activate or deactivate the output rate for automatic data output.
	Climate modules		Define the settings for the connected climate module.
	Connected devices	Motion sensor	Define the number and function of the gestures and the sensitivity. Only available if a motion sensor is connected to the device.
		File transfer	Display, edit, or delete settings for the USB connection. Define the settings for FTP transfer if this extension has been configured in the QAPP center.
	Device Settings	Date and time	NTP configuration
Set the date and time			Enter a date and time. Determine the time zone.
Safe weighing		isoCAL execution mode	Set the isoCAL function.
		Safety level	Set the alert level for the message indicating that the isoCAL function must be executed.
minUSP		minUSP function	If this extension has been activated in the QAPP center: Activate or deactivate the minimum weight.
		Starting point of operating range	If this extension has been activated in the QAPP center: Define the starting point value.
		Mark weight values < minUSP as invalid	If this extension has been activated in the QAPP center: Activates the identification of weight values that are less than the minimum weight.
Device ID		Device ID 1–2	Determine the device identifier.
Electronic signature		Sign report	If the QAPP extension has been activated: Activate or deactivate the electronic signature.
Start-up behavior		Initial zeroing/taring	Activate or deactivate automatic zeroing and taring when starting the device.
	Automatic login	Activate or deactivate automatic log-in of the last user when starting the device.	
	Automatic start of last task	Activate or deactivate automatic start of the last task when starting the device.	

Level 1	Level 2	Level 3	Description
	Display properties	Display brightness	Define the brightness of the operating display.
		On/off switch	Activate or deactivate the "energy saving" function.
		Color scheme	Define the settings for the operating display color scheme if this extension has been configured in the QAPP center.
	Sound (loudspeaker)	Touch sounds	Activate or deactivate the acoustic signal when operating a button.
		Message sounds	Activate or deactivate the acoustic signal for messages.
		Sound for end-of-action	Activate or deactivate the acoustic signal for the end of an action.
Device Maintenance	Update firmware	USB stick	Update the firmware. The menu is not available for conformity-assessed devices.
	Refreshed QAPP center	USB stick	Update the QAPP center using the connected USB stick.
	Update customized QAPP	USB stick	Update the customized QAPP using the connected USB stick.
	Device data backup	USB stick	Save the device data on a connected USB stick.
	Restore device data	USB stick	Load the device data from a connected USB stick.
	Export device data	Role management	Save device role management for an administrator, user, or guest on a connected USB stick.
		User management	Save device user management for an administrator, user, or guest on a connected USB stick.
	Import device data		Load the device data from a connected USB stick.
	Restore factory settings		Reset the device to factory settings and delete all configurations. The audit trail and data memory will be retained.
Create diagnostic file		Save information about the device configuration and the ongoing operation on a connected USB stick.	

4.15 Navigating the Menus

Procedure

- ▶ To open a menu from the main menu: Tap on the desired menu button in the function bar.
- ▶ The menu opens and the name of the open menu is displayed in the navigation bar.
- ▶ To return to the main menu from other displays: Press the [Menu] button or press the [Back] button (multiple times) until the main menu is displayed.

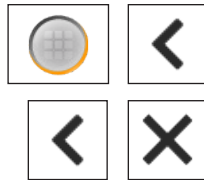

- ▶ To exit a display: Press the [Back] or [Cancel] button.

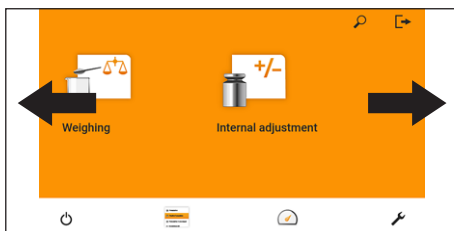

- ▶ To scroll through the tasks available in the main menu: Swipe the task bar to the left or right.

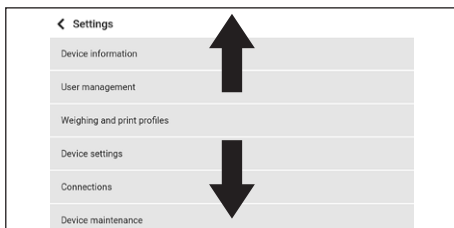

- ▶ To scroll through the list of options in an administration menu (settings, tasks, applications, ...): Swipe the list downwards or upwards.

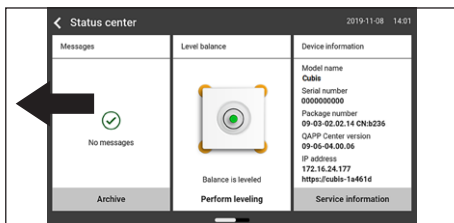

- ▶ To display the next page in a display containing several pages, e.g. in the Status Center: Swipe the display to the left.

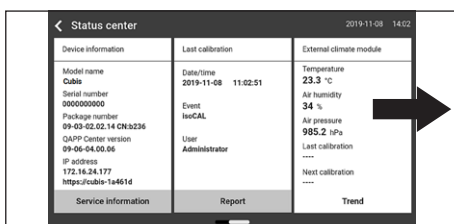

- ▶ To display the previous page in a display with several pages: Swipe the display to the right.

- ▶ If a value needs to be selected from a list:
 - ▶ Scroll to the desired value in the display. In order to do so, swipe the display upwards or downwards.
 - ▶ Press the desired value.
 - ▶ To confirm the selection: Press the [OK] button.
- ▶ The selected value is saved and the list closes.



- ▶ If elements from a display need to be filtered or a display needs to be browsed:
 - ▶ Press the [Search] or [Filter] button.
 - ▷ The keypad is displayed.
 - ▶ Type the searched value or value to be filtered into the entry field (1) using the keypad.
 - ▶ Press the [OK] button.
- ▶ To close the entry field for searching and filtering without starting a search or filter operation: Enter **no** value in the entry field or delete the entered value.
 - ▶ Press the [OK] button.

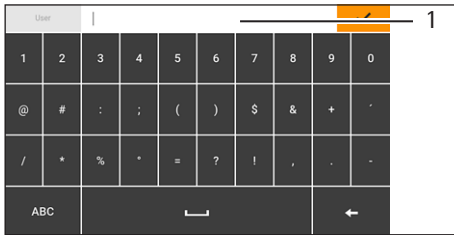

- ▶ If language-specific characters need to be entered using the keypad:
 - ▶ Press and hold a letter on the keypad.
 - ▷ If language-specific characters are available for the letter being pressed: A display opens containing all the language-specific characters available for the letter being pressed.
 - ▶ To select a language-specific character and return to the keypad display: Tap on the desired language-specific character.

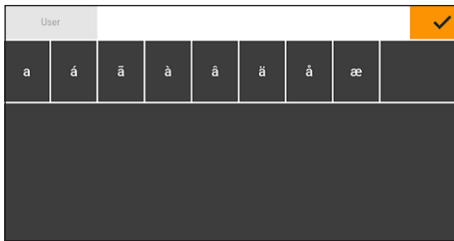

5 Installation

5.1 Scope of Delivery

Item	Quantity
Device	1
Weighing pan	1
Shield disk	1
Pan support	1
Power supply unit	1
Country-specific power supply cable with test seal	1
USB connection cable	1
In-use dust cover for control unit	1
In-use dust cover for the weighing module	1

5.2 Selecting an Installation Site

Procedure

- Make sure that the following conditions are met at the installation site:

Condition	Features
Ambient conditions	Suitability tested (see Chapter "15.2 Ambient Conditions", page 74)
Setup surface	<p>Stable, even surface that is not exposed to vibrations</p> <p>Not directly against a wall</p> <p>Sufficiently dimensioned for the device and the peripheral devices (device space requirements see Chapter "15.1 Dimensions and Weight", page 74; peripheral device space requirements see instructions for the peripheral devices, e.g. printer)</p> <p>Sufficient load-bearing capacity for the device and the peripheral devices even when full (device weight see Chapter "15.1 Dimensions and Weight", page 74; weight of the peripheral devices see instructions for the peripheral devices, e.g. printer)</p>
Access	Barrier-free

5.3 Unpacking the Device

Procedure

- ▶ Lift the device with the styrofoam padding out of the packaging.
- ▶ Place the device in the styrofoam padding on its side.
- ▶ Lift the Styrofoam padding off the device.
- ▶ Place the device on its base.
- ▶ Keep all parts of the original packaging, e.g. to return the device.

5.4 Removing the Control Unit

The control unit can be removed. This enables the flexible setup of the display and control unit at the workplace.

Tool: 1 Torx Allen key, T20

Material: 1 soft support base

Requirements

The weighing pan and all associated components are **not** placed on the device, e.g. shield ring, pan support.

Procedure

- ▶ Turn over the device and place on a soft surface.

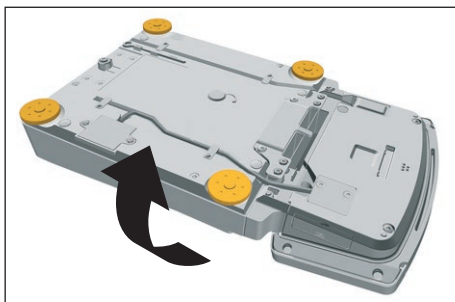

- ▶ To loosen the control unit's retainer: Use the Torx Allen key to remove both screws.
- ▶ Remove the control unit and re-insert both screws into the threaded holes.

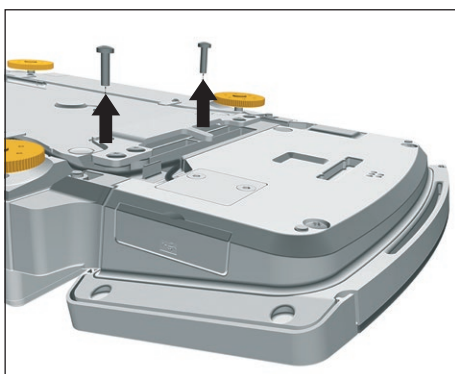

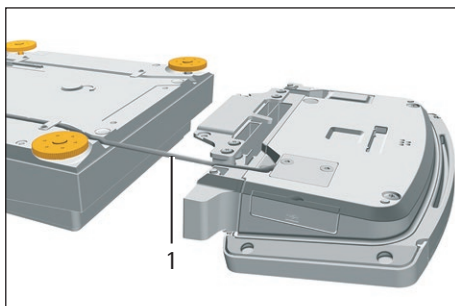

- ▶ Pull the connection cable (1) between the control unit and the weighing module out of the control unit's retainer and unroll it.

- ▶ Turn the device over again and place it on an even surface.

5.5 Connecting the Ethernet Cable

Material: 1 Ethernet cable
1 soft support base

Requirements

The weighing pan and the associated components have **not** been set up.

Procedure

- ▶ If the control unit is attached to the weighing module: Turn over the device and place on a soft surface.
- ▶ If the control unit is removed from the weighing module: Turn over the control unit and place on a soft surface.
- ▶ Remove the cover (3) of the Ethernet connection socket on the underside of the display and control unit.
- ▶ Plug the Ethernet cable into the Ethernet connection socket.
- ▶ If the control unit is attached to the weighing module: Place the Ethernet cable into the cable channel (1) and turn the cable lock (2) using the Ethernet cable.
- ▶ If the control unit is removed from the weighing module: Place the Ethernet cable in the cable channel.
- ▶ Place the device back on the device base on a level surface.

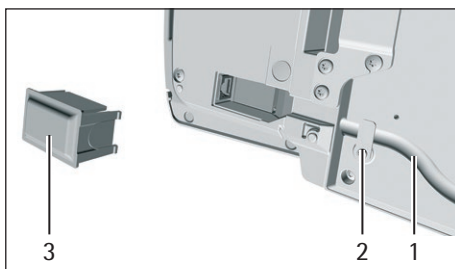

5.6 Preparing Below-balance Weighing

The device can be configured for below-balance weighing. Samples can be suspended for weighing using below-balance weighing, e.g. samples, which do **not** fit on the weighing pan.

For below-balance weighing, the hook must be installed in the device base and the device set up on a weighing table with recess.

M

In legal metrology:

- The below-balance weighing equipment may **not** be used.
- The cover of the below-balance weighing equipment may **not** be opened.

Material: 1 soft support base
1 draft protection shield
1 weighing table with recess

Requirements

The weighing pan and the associated components have **not** been set up.

Procedure

- ▶ Turn over the device and place on a soft surface.

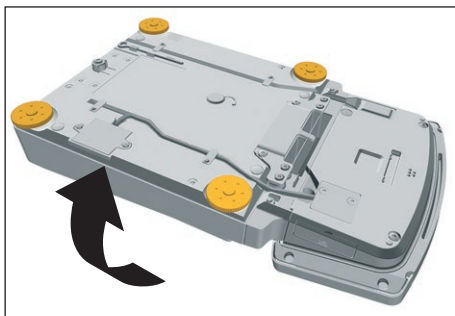

- ▶ Remove the hook for below-balance weighing (1) from the retainer on the underside of the base of the device.

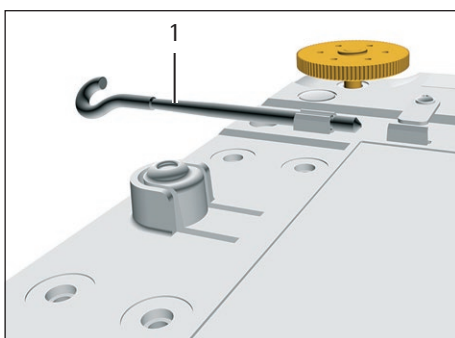

- ▶ Pull out the cover (2) of the below-balance weighing equipment.
- ▶ **NOTICE** Damage to the device from cross-threading! Ensure that the hook for below-balance weighing is inserted straight into the thread opening (1).

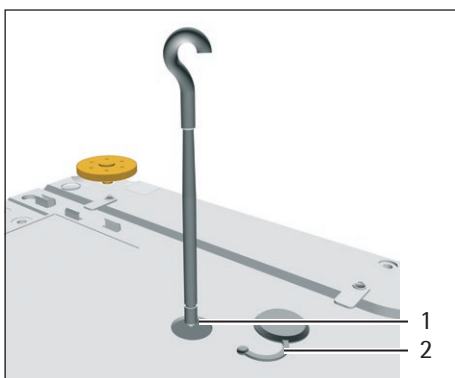

- ▶ Set up the device on the weighing table with recess. The hook for below-balance weighing may **not** touch the floor.
- ▶ Install a draft protection shield.
- ▶ Suspend the sample on the hook for below-balance weighing, e.g. with a wire.

5.7 Positioning the Weighing Pan and Associated Components

Procedure

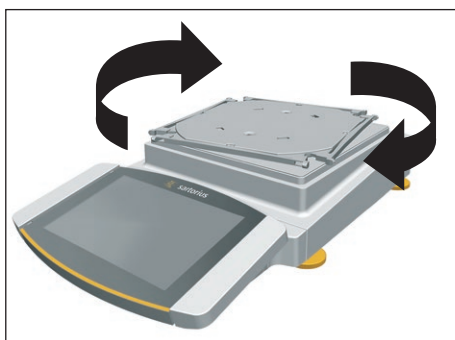

- ▶ Place the pan support down on the retainer, diagonally to the weighing module, and apply gentle pressure.
- ▶ Carefully turn the pan support clockwise until the two buttons engage.
- ▶ The pan support is now attached.

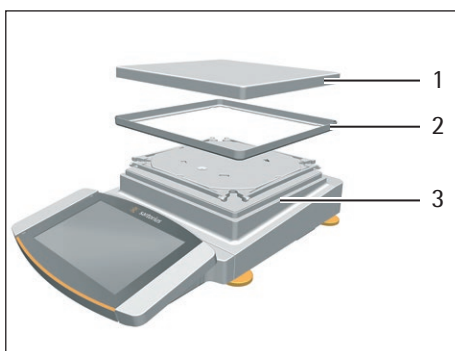

- ▶ Place the shield ring (2) on the weighing module (3).
- ▶ Place the weighing pan (1) on the pan support.

5.8 Acclimatization

When a cold device is brought into a warmer area: The temperature difference can lead to condensation of humidity in the device (moisture formation). Moisture in the device can lead to malfunctions.

- ▶ Allow the device to acclimatize for approx. 2 hours at the installation site. Ensure that the device is disconnected from the power supply during that time.

6 Getting Started

6.1 Installing the AC Adapter

Procedure

- ▶ **NOTICE** Improper connection may damage the device! If the device is connected using electronic components, e.g. printer, PC: The device must be disconnected from the power supply. Ensure that the device is disconnected from the power supply.
- ▶ Connect the device using electronic components (see electronic components instructions).

Procedure

- ▶ Plug the DC supply cable of the AC adapter into the device's "power supply" connection socket and tighten the threaded fitting.



- ▶ Connect the power supply cable to the AC adapter connection.

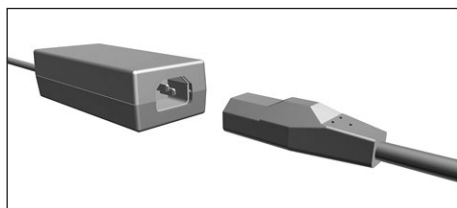

6.2 Connecting the Power Supply

Procedure

- ▶ **⚠ WARNING** Severe injuries caused by using a defective power supply cable! Check the power supply cable for damage, e.g., cracks in the insulation.
 - ▶ If required: Contact Sartorius Service.
- ▶ Check whether the country-specific power plug matches the power connections at the installation site.
 - ▶ If required: Contact Sartorius Service.
- ▶ **NOTICE** Damage to the device due to excessive input voltage! Check whether the voltage specifications on the AC adapter match those of the power supply at the installation site.
 - ▶ If the input voltage is too high: Do **not** connect the device to the power supply.
 - ▶ Contact Sartorius Service.
- ▶ Connect the mains plug of the power supply cable to the wall outlet at the installation site.
 - ▷ The [Booting device...] display appears in the operating display.
 - ▷ The [Starting system...] display appears in the operating display.
 - ▷ The [Starting application...] display appears in the operating display.
 - ▷ The [Loading] display appears in the operating display.
 - ▷ The device performs an initial tare function.

6.3 Attaching the Protective Caps

If connections of the device are **not** being used during operation: The connections must be sealed with the protective caps supplied.

Procedure

- ▶ Check whether all unused connections have been sealed with a protective cap.
- ▶ Place the protective caps (1) for the electrical connections on the unused connections.

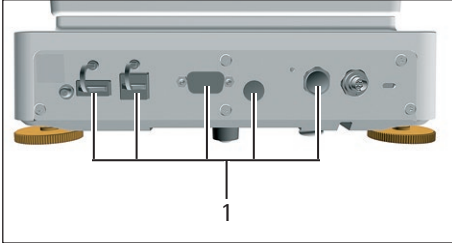

7 System Settings

7.1 Performing System Settings

Default settings can be adjusted for the device and the applications in order to align with the ambient conditions and individual operating requirements.

The following settings are necessary to operate the device together with connected components:

- Set up the communication of the connected devices
- Set up additional components

The following settings are recommended to set up the device:

- Set the menu language
- Select date/time format
- Set date/time
- Assigning a Password
- Set the behavior of the isoCAL function

Procedure

- ▶ Open the main menu.
- ▶ Press the [Setup] button.
- ▶ To adjust settings: Open the desired submenu.
- ▶ Select the desired configuration value (configuration values, see Chapter "7.5 Parameter List", page 45).
- ▶ Exit the menu.

7.2 Switching Off the isoCAL Function

M

If the isoCAL function is switched off for a conformity-assessed device: The device can only be used for legal-for-trade applications in restricted temperature ranges (see Chapter "15.2.2 Ambient Temperature for the isoCAL Function", page 75). The isoCAL function **cannot** be switched off for all model versions.

Procedure

- ▶ In the "Settings/Device Settings/isoCAL" menu, for the "isoCAL function" parameter, select the "Off" configuration value.

7.3 Assigning a Password

Procedure

- ▶ Log into the device using the user profile; a password should be assigned.
- ▶ Open the "Settings/User Management" menu.
- ▶ Press the [Lock] button.
- ▷ The user password input field is displayed.
- ▶ Enter the desired password in the entry field and confirm with the [OK] button.

7.4 Setting Up Device for Network Printer

7.4.1 Selecting Configuration for Network Printing

Two configurations are possible:

- The device and the network printer communicate via an independent Wi-Fi network with standard Wi-Fi components. No security guidelines or network settings need to be taken into consideration here. This configuration is recommended if no other network functions are being used and simple printing is enough.
- The device communicates with a company network via Wi-Fi. The network printer is connected to the company network. All the device's network functions can be used in the entire company network. This configuration has 2 restrictions:
 - The company network must have a DHCP server.
 - Login via Wi-Fi only supports standard authentication methods and no special security guidelines. This connection **cannot** be used in company networks that require special security guidelines.

Procedure

- ▶ Check which configuration is suitable for network printing.

7.4.2 Setting Up Device for Network Printer via Independent Wi-Fi Network

Requirements

- The device administrator or service rights are activated via user management.
- The network printer is connected to a Wi-Fi router.

Procedure

- ▶ Check the suitability of the Wi-Fi router and Wi-Fi stick (for suitability, see Chapter "16.1.1 Printers and Communication", page 82).
- ▶ Insert the Wi-Fi stick into the device in a USB connection.
- ▶ Open the "Settings/Connections/Network/Wi-Fi" menu.
- ▶ Press the [Edit] button.
- ▶ Enter the service set identifier for the router under "Wi-Fi SSID". The service set identifier is specified on the back of the Wi-Fi router.
- ▶ Enter the router password under "Wi-Fi password". The password is specified on the back of the Wi-Fi router.
- ▶ Press the [Back] button.
- ▷ The status "Ready" appears in the "Wi-Fi" overview display within 10 seconds.

Creating a Network Printer

Procedure

- ▶ Open the "Settings/Connections/Connectors/YDP30-NET" menu.
- ▶ Press the [New] button.
- ▶ Enter a name for the network printer under "Connector name", e.g. printer YDP30-NET.
- ▶ Enter the network printer IP address under "IP or host". The IP address of the computer is specified in the network printer "Network Settings" printout.
- ▶ Confirm the entries. In order to do so, press the [OK] button.

7.4.3 Setting Up Device for Network Printer via Company Network

Requirements

- The device administrator or service rights are activated via user management.
- The company network has a DHCP server.
- The network printer is connected to the company network.

Procedure

- ▶ Open the "Settings/Connections/Network/Wi-Fi" menu.
- ▶ Press the [Edit] button.
- ▶ Enter the service set identifier for the company network under "Wi-Fi SSID". The service set identifier is available from the company network administrator.
- ▶ Enter the company network password under "Wi-Fi password". The password is available from the company network administrator.
- ▶ Press the [Back] button.
- ▷ The status "Ready" appears in the "Wi-Fi" overview display within 10 seconds.

Creating a Network Printer

Procedure

- ▶ Open the "Settings/Connections/Connectors/YDP30-NET" menu.
- ▶ Press the [New] button.
- ▶ Enter a name for the network printer under "Connector name", e.g. printer YDP30-NET.
- ▶ Enter the network printer "HOST NAME" under "IP or host". The HOST NAME of the computer is specified in the network printer "Network Settings" printout.
- ▶ If connection with the host name is delayed: Enter the network printer IP address under "IP or host". The IP address of the computer is specified in the network printer "Network Settings" printout.
- ▶ Confirm the entries. In order to do so, press the [OK] button.
- ▶ If the IP address changes depending on the DHCP network settings: Enter the new IP address of the network printer again.

7.4.4 Configure Print Profile

Procedure

- ▶ Open the "Settings"/Weighing and Print Profile/YDP30" menu.
- ▶ Edit a pre-configured print profile or create a new print profile by pressing the [New] button, e.g. network printer YDP30-NET.
- ▶ Follow the wizard's instructions in the operating display for more settings.
- ▶ Confirm the entries. In order to do so, press the [OK] button.
- ▶ Add the created print profile to a task (see Chapter "8.5 Adding Weighing and Print Profiles to a Task", page 60).

7.5 Parameter List

7.5.1 Parameters in the "User Management" Menu

Parameter	Settings	Explanation
User name	User input	Assign a name for the user profile.
User description	User input	Enter a description for the user profile.
Role	Administrator	If the QAPP extension "User Management" has been activated: Activates the administrator functions.
	User*	If the QAPP extension "User Management" has been activated: Activates the user functions.
	Guest	If the QAPP extension "User Management" has been activated: Activates the guest functions.
Language		Set the language for the user profile.
User color profile	Sartorius Standard*	If the QAPP extension "Color Scheme" has been activated: Define a user color for the user profile.
Login method		Determine whether the user password is saved locally on the device or provided by an LDAP network server.
* Factory setting		

7.5.2 Parameters in the "Access Management" Menu

Parameter	Settings	Explanation
Role management	Administrator	If the QAPP extension "User Management" has been activated: Define the role names, description, and rights for the administrator.
	User	If the QAPP extension "User Management" has been activated: Define the role names, description, and rights for the user.
	Guest	If the QAPP extension "User Management" has been activated: Define the role names, description, and rights for the guest.
Rules	Autom. logout after inactivity	If the QAPP extension "User Management" has been activated: Switches the device into standby mode after the selected time.
	Max. failed attempts	If the QAPP extension "User Management" has been activated: Define the number of maximum failed attempts for password entry.
	After maximum failed entries ...	If the QAPP extension "User Management" has been activated: Activates the action after failed attempts at entering the password.
Local password rules		If the QAPP extension "User Management" has been activated: Define the permissible characters, length, and validity time for the password.
LDAP server configuration		If the QAPP extension "User Management" has been activated: Configure the data for device communication with an LDAP server.
* Factory setting		

7.5.3 Parameters in the "Timer-Controlled Actions" Menu

Parameter	Settings	Explanation
Start task	Execution date	Activates the date and time for starting the task.
	Repeat period	Repeats in minutes, hours, days, months, or years.
	Name	Saves a name for the timer-controlled action.
	Action execution	Sets the execution of the action to cancelable or not cancelable.
	Task to start	Activates the desired task.
Display message	Execution date	Activates the date and time for displaying the message.
	Repeat period	Repeats in minutes, hours, days, months, or years.
	Name	Saves a name for the message.
	Message title	Saves a message title.
	Message content	Saves message content.
Standby mode	Execution date	Activates the date and time for standby mode.
	Repeat period	Repeats in minutes, hours, days, months, or years.
	Name	Saves a name for standby mode.
	Action execution	Sets the execution of the action to cancelable or not cancelable.
Wake-up from standby	Execution date	Activates the date and time for execution.
	Repeat period	Repeats in minutes, hours, days, months, or years.
	Name	Saves a name for wake-up from standby.
Switch-off	Execution date	Activates the date and time for switch-off.
	Repeat period	Repeats in minutes, hours, days, months, or years.
	Name	Saves a name for switch-off.
	Action execution	Sets the execution of the action to cancelable or not cancelable.
Automatic backup	Execution date	Activates the date and time for automatic backup.
	Repeat period	Repeats in minutes, hours, days, months, or years.
	Name	Saves a name for automatic backup.
	Action execution	Sets the execution of the action to cancelable or not cancelable.
	Backup to connector	Activates the desired connector, e.g. a USB stick.
Export audit trail	Execution date	Activates the date and time for exporting the audit trail.
	Repeat period	Repeats in minutes, hours, days, months, or years.
	Name	Saves a name for the audit trail export.
	Action execution	Sets the execution of the action to cancelable or not cancelable.
	Export to connector	Activates the desired connector for the export, e.g. a USB stick.
	Modules for export	Activates the respective module to be saved, e.g. audit trail, menu settings, etc.

* Factory setting

7.5.4 Parameters in the "Weighing and Print Profiles/Weighing" Menu

Parameter	Settings	Explanation
Ambient conditions	Very stable	Sets the ambient conditions to "very stable": Activates a fast change in the weight values in the event of a load change with a high output rate. Recommended for the following work environment: <ul style="list-style-type: none"> – Very stable table near the wall – Closed and calm room
	Stable	Sets the ambient conditions to "stable". Recommended for the following work environment: <ul style="list-style-type: none"> – Stable table – Slight movement in the room – Slight draft
	Unstable*	Sets the ambient conditions to "unstable": Activates the delayed change in weight values with a reduced output rate. Recommended for the following work environment: <ul style="list-style-type: none"> – Simple office desk – Room with moving machinery or personnel – Slight air movement
	Very unstable	Sets the ambient conditions to "very unstable": Activates a significantly delayed change in the weight values and long wait for stability with a further reduction in the output rate. Recommended for the following work environment: <ul style="list-style-type: none"> – Noticeable and slow floor vibrations – Noticeable building vibrations – Weighed goods moved – Very strong air movements
Application filter	Weighing (final readout)*	Activates a filter that enables a fast change in the display for very fast load changes. Display changes with minimal load changes (in the digit range) occur more slowly.
	Dosing (filling mode)	Activates a filter that enables a very fast change in the display with minimal load changes (e.g. when filling containers).
	Sensor mode (low filtering)	Activates a weak but fast filter that always behaves in the same way for load changes (e.g. when filling automated systems).
	Dynamic mode (without filtering)	Deactivates the active application filter.
Stability	Very high accuracy	Sets the stability to "very high accuracy".
	High accuracy	Sets the stability to "high accuracy".
	Medium accuracy*	Sets the stability to "medium accuracy".
	Fast	Sets the stability to "fast".
	Very fast	Sets the stability to "very fast".
	Very slow	Sets the stability to "very slow".
* Factory setting for the "Standard Weighing" factory-set weighing profile		

Parameter	Settings	Explanation
Stability delay	Very short	Sets the stability delay to "very short": The stability symbol is displayed after the stability criterion is reached.
	Short*	Sets the stability delay to "short": The stability symbol only appears after a short delay in order to provide a reliable result despite fluctuations.
	Medium	Sets the stability delay to "medium": The stability symbol only appears after a longer delay in order to provide a reliable result in case of higher fluctuations.
	Long	Sets the stability delay to "long": The stability symbol only appears after a long delay in order to balance out major instability.
Zeroing/Taring	Without stability	Without stability: The function of the [Zero] or [Tare] key is executed immediately once the key is pressed.
	After stability*	After stability: The function of the [Zero] or [Tare] key is only executed after stability is achieved.
	At stability	At stability: The function of the [Zero] or [Tare] key is executed if stability exists when the key is pressed.
Automatic zeroing	On*	Activates automatic zeroing. The display is automatically set to zero in case of a deviation of 0 less than (X).
	Off	Deactivates automatic zeroing. Zeroing must be triggered with the [Zero] key.
Preset tare 1	On*	Activates the second tare memory (preset tare).
	Off	Deactivates the second tare memory (preset tare).
Available units		The availability of units may depend on national legislation and is therefore country-specific. Multiple selection is possible.
	mg – milligrams	The device displays the weight in milligrams.
	g – grams*	The device displays the weight in grams.
	kg – kilograms	The device displays the weight in kilograms.
	ct – carats	The device displays the weight in carats.
	oz – ounces	The device displays the weight in ounces.
	lb – pounds	The device displays the weight in pounds.
	ozt – troy ounces	The device displays the weight in troy ounces.
	tlh – Hong Kong taels	The device displays the weight in taels (Hong Kong).
	tls = Singapore taels	The device displays the weight in taels (Singapore).
	tlt – Taiwanese taels	The device displays the weight in taels (Taiwan).
	tlc = Chinese taels	The device displays the weight in taels (China).
	GN – grain	The device displays the weight in grains.
	dwt = pennyweight	The device displays the weight in pennyweights.
	mom – mommes	The device displays the weight in mommes.
	tol – tolas	The device displays the weight in tolas.
bat – baht	The device displays the weight in baht.	
MS – mesghals	The device displays the weight in mesghals.	
N – newtons	The device displays the weight in newtons.	

* Factory setting for the "Standard Weighing" factory-set weighing profile

Parameter	Settings	Explanation
Available resolutions	All digits on*	"All digits on": All decimal places are shown in the display. Not available on conformity-assessed devices.
	Last digit off at load change	"Reduced by 1 decimal place for load change": The last decimal place on the display is switched off until stability is achieved.
	Last digit scale interval 1	"Last digit scale interval 1": The last decimal place always shows the 1st division.
	Last digit off	"Last digit off": The last decimal place is switched off.
Profile name	User input	Saves a name assigned for the weighing profile, e.g. "My Weighing".
Profile description	User input	Saves a description for the weighing profile entered (optional).

* Factory setting for the "Standard Weighing" factory-set weighing profile

7.5.5 Parameters in the "Weighing and Print Profiles/YDP30, PDF, CSV, PC Direct, or SBI Direct" menu

Parameter	Settings	Explanation
GLP printing	Off*	Deactivates the GLP printout.
	On	The GLP printout is always switched on. All printouts contain a GLP header and a GLP footer.
Date/time	Off*	Exports the measured value without the date and time.
	On	Exports the measured value with the date and time.
Block pressure (N,T,GC)	Off*	Exports the measured value without the gross, net, and tare value.
	On	Exports the measured value with the gross, net, and tare value.
Memory ID	Off*	Deactivates the ID marking for the data storage device.
	On	Activates the ID marking for the data storage device.
Connectors	YDP30	Displays the activated connector for printing.
	YDP30-NET	Displays the activated connector for printing.
	USB stick	Displays the connector for the PDF document or spreadsheet (CSV).
Data fields	Title	Spreadsheet format (CSV): Sends the output with title.
	Header	Spreadsheet format (CSV): Sends the output with header.
	Value	Spreadsheet format (CSV): Sends the output with the value.
	Unit	Spreadsheet format (CSV): Sends the output with the unit.
Decimal separator	Period	Spreadsheet format (CSV): Transmits the value with a decimal period to the PC program, e.g. 99.963 g.
	Comma*	Spreadsheet format (CSV): Transmits the value with a decimal comma to the PC program, e.g. 99,963 g.
Column separator	Tab*	Spreadsheet format (CSV): Activates the tab character between the individual data fields in the spreadsheet.
	Space	Spreadsheet format (CSV): Activates the space between the individual data fields in the spreadsheet.

* Factory setting

Parameter	Settings	Explanation
Print mode	Report with print preview*	Displays the data to be printed in the operating display before printing.
	Immediate output without preview	Prints the determined data directly on the connected printer.
Paper	Continuous*	Continuously prints the individual printouts on the strip printer.
GLP header or GLP footer: Content 1 to 20	Not used	If the respective selected lines 1 to 20 are not used for this protocol.
	Horizontal line	Prints a horizontal line.
	Dashed line	Prints a dashed line.
	Blank line	Prints a blank line.
	User text 1	Prints an entered description, e.g. the name of the print profile.
	User text 2	Prints an additional entered description.
	Manufacturer	Prints the device manufacturer, e.g. "Sartorius".
	Model name	Prints the device model name.
	Serial number	Prints the device serial number.
	Package version	Prints the device package version.
	Task name	Prints the respective task name.
	QAPP version	Prints the QAPP version of the application.
	Last calibration	Prints the date/time of the last calibration/adjustment.
	Device ID 1	Prints the entered device ID 1.
	Device ID 2	Prints the entered device ID 2.
	Date/time	Prints the current date and time.
	Time zone	Prints the name of the selected time zone.
	User name	Prints the name of the user.
	Signature	Prints a line for signature.
	minUSP	Prints the minimum weight according to USP.
Air temperature, internal module	Prints the current determined air temperature.	
Air humidity, internal module	Prints the current determined air humidity.	
Air pressure, internal module	Prints the current determined air pressure.	
Air temperature, external module	Prints the current determined air temperature of a connected climate module.	
Air humidity, external module	Prints the current determined air humidity of a connected climate module.	
Air pressure, external module	Prints the current determined air pressure of a connected climate module.	
User text 1	User input	Saves the entered description, e.g. the name of the print profile.
User text 2	User input	Saves an additional description.
Profile name	Printer YDP30 (only weight values)	Saves a name assigned for the print profile, e.g. "Printer YDP30".
Profile description	User input	Saves an entered description for the print profile.
* Factory setting		

7.5.6 Parameters in the "Connections/Connectors" Menu

Parameter	Settings	Explanation
USB	Connector name	Saves the entered name for a USB stick.
	Destination directory	Saves the name of a destination directory.
YDP30-NET	Connector name	Saves the entered name for a USB stick.
	IP or host	Enter the IP or host address for the printer.
	Port	Define the port for the printer.
FTP or FTPS	Connector name	If the QAPP extension has been activated: Saves the entered name of an FTP or FTPS server.
	IP address	If the QAPP extension has been activated: Enter the IP address for the device.
	Port	If the QAPP extension has been activated: Define the port for the device.
	Sub-directory	If the QAPP extension has been activated: Saves the name of a sub-directory.
	User	If the QAPP extension has been activated: Saves the name of a user.
	Password	If the QAPP extension has been activated: Saves a password for FTP or FTPS access.
Network printer	Connector name	Saves the entered name for a USB stick.
	IP or host	Enter the IP or host address for the printer.
	Protocol	Define the protocol for the printer: Socket, IPP, HTTP or LDP.
SMB	Connector name	If the QAPP extension "Windows File Server" has been activated: Saves the entered name of a Windows file server.
	//Host/Share	If the QAPP extension "Windows File Server" has been activated: Enter the host and share names of the Windows file server.
	Sub-directory	If the QAPP extension "Windows File Server" has been activated: Saves the name of a sub-directory.
	User	If the QAPP extension "Windows File Server" has been activated: Saves the name of a user.
	Password	If the QAPP extension "Windows File Server" has been activated: Saves a password for access to the Windows file server.

* Factory setting

7.5.7 Parameters in the "Connections/Network" Menu

Parameter	Settings	Explanation
General settings	Host name	Saves the device host name.
Ethernet	IPv4 method	Sets the method to DHCP, Manual or Off.
	IPv6 method	Sets the method to Auto, Manual or Off.
	DNS 1	Saves the value for DNS 1.
	DNS 2	Saves the value for DNS 2.
Wi-Fi	Wi-Fi SSID	Saves the name of the WI-FI SSID.
	Wi-Fi password	Saves a password for Wi-Fi access.
	IPv4 method	Sets the method to DHCP, Manual or Off.
	IPv6 method	Sets the method to Auto, Manual or Off.
	DNS 1	Saves the value for DNS 1.
	DNS 2	Saves the value for DNS 2.
* Factory setting		

7.5.8 Parameters in the "Connections/Website/Web Services" Menu

Parameter	Settings	Explanation
Website access	Deactivated	Deactivates the display of the website for the device.
	On, without authentication*	Sets the display options of the website for the device to "without authentication".
Remote access	Display only*	Permits remote access in view mode via a browser.
	View and remote control	Permits remote access via a browser.
Web service password	User input	Saves a password for web service access.
* Factory setting		

7.5.9 Parameters in the "Connections/Interfaces/Serial Communication via Network" (Ethernet) Menu

Parameter	Settings	Explanation
Protocol	Off	Deactivates the serial transmission via Ethernet.
	SBI*	Enables SBI communication. The data is output to a PC or control unit. Enables the use of ESC commands from a PC to control the basic balance functions with ASCII protocol.
	SICS	Enables SICS communication. The data is output to a PC or control unit. Enables the use of commands from a PC to control the basic balance functions with SICS protocol.
	xBPI	Extended range of commands to control numerous balance functions with binary protocol for direct communication with the weighing module.
Log communication	On	Activates the automatic data recording for this interface.
	Off*	Deactivates the automatic data recording for this interface.
Port	User input	Saves the entered port number for the Ethernet interface.
* Factory setting		

7.5.10 Parameters in the "Connections/Interfaces/COM-RS232 Interface" Menu

Parameter	Settings	Explanation
Protocol	Off*	Deactivates the RS232 connection.
	SBI	Enables SBI communication. The data is output to a PC or control unit. Enables the use of ESC commands from a PC to control the basic balance functions with ASCII protocol.
	xBPI	Extended range of commands to control numerous balance functions with binary protocol for direct communication with the weighing module.
Log communication	Off*	Deactivates the automatic data recording for this interface.
	On	Activates the automatic data recording for this interface.
Baud rate	600 baud	Sets the baud rate to 600 baud.
	1200 baud	Sets the baud rate to 1200 baud.
	2400 baud	Sets the baud rate to 2400 baud.
	4800 baud	Sets the baud rate to 4800 baud.
	9600 baud*	Sets the baud rate to 9600 baud.
	19200 baud	Sets the baud rate to 19200 baud.
	38400 baud	Sets the baud rate to 38400 baud.
	57600 baud	Sets the baud rate to 57600 baud.
Data bits	7 data bits	Sets the number of data bits to 7.
	8 data bits*	Sets the number of data bits to 8.
Parity	Odd*	Applies an odd parity.
	Even	Applies an even parity.
	None	Does not apply a parity.
Stopbits	1 stop bit*	Sets the number of stop bits to 1.
	2 stop bit	Sets the number of stop bits to 2.
Handshake	Software	Sets the handshake protocol to software handshake.
	Hardware*	Sets the handshake protocol to hardware handshake.
	None	Does not set a handshake protocol.

* Factory setting

7.5.11 Parameters in the "Connections/Interfaces/USB-B Interface" Menu

Parameter	Settings	Explanation
Protocol	Off*	Deactivates the USB-B connection.
	SBI	Enables SBI communication. The data is output to a PC or control unit. Enables the use of ESC commands from a PC to control the basic balance functions with ASCII protocol.
	SICS	Enables SICS communication. The data is output to a PC or control unit. Enables the use of commands from a PC to control the basic balance functions with SICS protocol.
	xBPI	Extended range of commands to control numerous balance functions with binary protocol for direct communication with the weighing module.
	PC direct	Enables data output to a spreadsheet program via a direct PC connection.
Log communication	Off*	Deactivates the automatic data recording for this interface.
	On	Activates the automatic data recording for this interface.

* Factory setting

7.5.12 Parameters in the "Connections/SBI Protocol" Menu

Parameter	Settings	Explanation
Format	Value without header	The data output only exports the measured value without ID code.
	Value (with header)*	The data output exports the measured value with ID codes.
	Date & time, value (two lines)	The data output exports the measured value, date, and time.
Output	Without stability*	The data is output without the weight value being stable.
	With stability	The data is output only when the weight value is stable.
Automatic data output	Off*	Deactivates the automatic data output. The data output must be triggered by means of an SBI command with "ESC P".
	Each weight value	Starts the automatic data output with each value according to the display result.
	1 second	Starts the automatic data output every second.
	2 seconds	Starts the automatic data output every 2 seconds.
	5 seconds	Starts the automatic data output every 5 seconds.
	10 seconds	Starts the automatic data output every 10 seconds.
	30 seconds	Starts the automatic data output every 30 seconds.
	60 seconds	Starts the automatic data output every 60 seconds.

* Factory setting

7.5.13 Parameters in the "Connections/Climate Module" Menu

Parameter	Settings	Explanation
Climate modules		

7.5.14 Parameters in the "Connections/Connected Devices/Motion Sensor" Menu (Only for Connected Motion Sensors)

Parameter	Settings	Explanation
Number of gestures	2 gestures (left, right)*	Activates the control of functions with 2 gestures. Gestures: left, right.
	4 gestures (left, right, up, down)	Activates the control of functions with 4 gestures. Gestures: left, right, down, up.
	Any gesture	Activates the control of functions with any gesture.
Gesture to the left	Start/cancel taring	The gesture starts a taring process or cancels a taring process.
Gesture to the right	Start/cancel zeroing	The gesture starts the zeroing process or cancels the zeroing process.
Gesture upwards		
Gesture downwards		

* Factory setting

7.5.15 Parameters in the "Device Settings/Date and Time" Menu

Parameter	Settings	Explanation
NTP configuration	NTP operating status	Activates or deactivates the time synchronization with the NTP server.
	Server IP	Saves the entered server ID for the NTP server.
Set the date and time	Date format	Sets the date display format to DD/MM/YYYY, MM/DD/YYYY, DD.MM.YYYY, YYYY-MM-DD (ISO)*, YYYY:MM:DD, DD-MMM-YYYY or MMM-DD-YYYY.
	Set date	Saves the entered date.
	Time format	Sets the time display format to HH.MM.SS, HH:MM:SS (ISO)* or HH:MM:SS am/pm.
	Set time	Saves the entered time.
	Time zone	Saves the selected time zone.

* Factory setting

7.5.16 Parameters in the "Device Settings/Safe Weighing" Menu

Parameter	Settings	Explanation
isoCAL execution mode	Off	Deactivates the isoCAL function. This setting change is not available for all models.
	Show status field, manual start	If the device must be calibrated: The [isoCAL] button is displayed as the predominant button in the operating display. The isoCAL function must be manually triggered using the [isoCAL] button.
	On, automatic execution*	Activates the isoCAL function. The device is automatically adjusted as soon as a trigger starts the isoCAL function.
	On, automatic execution with linearization (only if possible)	Activates the isoCAL and linearization function. The device is automatically adjusted and then linearized as soon as a trigger starts the isoCAL function.
Safety level	Off	If the isoCAL function must be carried out: The device displays a status message.
	Warning*	If the isoCAL function must be carried out: The device displays a warning message. Some device functions are limited until isoCAL has been executed: The displayed weight value is marked as invalid; printed data are marked with [!].
	Strict	If the isoCAL function must be carried out: The device displays an error message. Some device functions are limited until isoCAL has been executed: The displayed weight value is marked as invalid; the starting of functions and saving of data in tasks is disabled; data output is deactivated.

* Factory setting

7.5.17 Parameters in the "Device Settings/minUSP" Menu

Parameter	Settings	Explanation
minUSP function	Off*	If this extension has been activated in the QAPP center: Deactivates minimum weight.
	On	If this extension has been activated in the QAPP center: Activates the minimum weight.
Starting point of operating range	User input	If this extension has been activated in the QAPP center: Define the starting point value.
Mark weight values < minUSP as invalid	Off*	If this extension has been activated in the QAPP center: Deactivates the identification of weight values that are less than the minimum weight.
	On	If this extension has been activated in the QAPP center: Activates the identification of weight values that are less than the minimum weight.

* Factory setting

7.5.18 Parameters in the "Device Settings/Device ID" Menu

Parameter	Settings	Explanation
Device ID 1	User input	Saves the entered device ID.
Device ID 2	User input	Saves the entered device ID.

7.5.19 Parameters in the "Device Settings/Electronic Signature" Menu

Parameter	Settings	Explanation
Sign report	Off*	If the QAPP extension has been activated: Deactivates electronic signature.
	On	If the QAPP extension has been activated: Activates electronic signature.

* Factory setting

7.5.20 Parameters in the "Device Settings/Start-up Behavior" Menu

Parameter	Settings	Explanation
Initial zeroing/taring	Off	Deactivates automatic zeroing and taring when starting the device.
	On*	Activates automatic zeroing and taring when starting the device.
Automatic login	Off	Deactivates "Automatic login". No user is logged in automatically when starting the device.
	Administrator*	Activates "Automatic login". The administrator is logged in automatically when starting the device.
	Operator	Activates "Automatic login". The selected user is logged in automatically when starting the device.
Automatic start of last task	Off*	No task is started automatically after device login.
	On	After logging-in on the device, the task being performed by the last user to be logged in starts automatically.

* Factory setting

7.5.21 Parameters in the "Device Settings/Display Properties" Menu

Parameter	Settings	Explanation
Display brightness	Bright	Sets the lighting intensity on the operating display to "bright".
	Medium	Sets the lighting intensity on the operating display to "medium".
	ECO mode*	Activates eco mode. For longer periods of downtime, the operating display darkens automatically.
On/off switch	Standby mode*	The [Standby] button switches the device into standby mode. The device can be reactivated by pressing the [Standby] button.
	Off	The [Standby] button switches the device off. The device must be reactivated by pressing the ON key.
Color scheme	Sartorius Standard*	If the QAPP extension has been activated: Selects the color scheme for the "Sartorius Standard" operating display. Additional color schemes can be unlocked via the QAPP center.
* Factory setting		

7.5.22 Parameters in the "Device Settings/Sound (Loudspeaker)" Menu

Parameter	Settings	Explanation
Touch sounds	Activated	Deactivates the acoustic signal for touch and keypad operation.
	Deactivated*	Activates the acoustic signal for touch and keypad operation.
Message sounds	Activated	Deactivates the acoustic signal for messages.
	Deactivated*	Activates the acoustic signal for messages.
Sound for end-of-action	Activated	Deactivates the acoustic signal for the completion of an action.
	Deactivated*	Activates the acoustic signal for the completion of an action.
* Factory setting		

7.5.23 Parameters in the "Device Maintenance" Menu

Parameter	Settings	Explanation
Update firmware		Starts a firmware update. Not for conformity-assessed devices.
Update QAPP Center	USB stick	Updates the QAPP center using the connected USB stick.
Update customized QAPP	USB stick	Updates the customized QAPP using the connected USB stick.
Backup device settings	USB stick	Saves the device data on a connected USB stick.
Restore device settings	USB stick	Loads the device data from a connected USB stick.
Export device data	Role management	Saves device role management for an administrator, user, or guest on a connected USB stick.
	User management	Saves device user management for an administrator, user, or guest on a connected USB stick.
Import device data	USB stick	Loads the device data from a connected USB stick.
Restore factory settings		Resets the device to factory settings and deletes all configurations. The audit trail and data memory will be retained.
Create diagnostic file		Saves information about device configuration and operation on a connected USB stick.

8 Operation

8.1 Switching the Device On and Off

The device only delivers accurate values if it has reached the necessary operating temperature. The warm-up time after switching the device on must therefore be complied with.

If the device is being switched on for the first time or if the device is switched on after being reset to factory settings: The Setup Wizard opens. All steps in the Setup Wizard must be completed.

Requirements

The device is connected to the power supply.

Procedure

- ▶ If the device does **not** switch on automatically after it is connected to the power supply: Press the ON key on the weighing module.
- ▶ **NOTICE** Pointed or sharp-edged objects may damage the operating display! Touching the operating display with objects, such as pens, may damage the touchscreen surface of the operating display. Only touch the operating display with your fingertips.
- ▶ If the Setup Wizard is shown: Follow the instructions in the Setup Wizard in the operating display.
- ▶ If the login display is displayed: Log into the device using a user profile.
- ▷ If the device is switched on after the Setup Wizard is complete and **no** passwords have been assigned for the user profiles: The user profile for the last user to be logged in is loaded.
- ▶ To allow the device to reach the necessary operating temperature to accurately determine the weight: Comply with the warm-up time of 30 minutes after switching the device on.
- ▷ If this relates to a conformity-assessed device: The weight value is marked as **invalid** during the warm-up period.
- ▶ To switch the device off: Disconnect the device from the power supply.

M

8.2 Logging Users In and Out

Procedure

- ▶ If the name of the desired user profile is displayed in the entry field (1) of the login display: Press the [Login] button.
- ▶ If the name of the desired user profile is **not** displayed in the entry field of the login display:
 - ▶ Tap on the entry field in the login display.
 - ▷ The user selection opens.
 - ▶ Press the name of the desired user profile.
 - ▶ If a password has been assigned for the desired user: Enter the password in the entry field and press the [OK] button.
 - ▷ The user profile opens and the main menu or the last task being performed by the active user is displayed.
- ▶ To log out the active user profile from the device: Press the [Log-out] button.

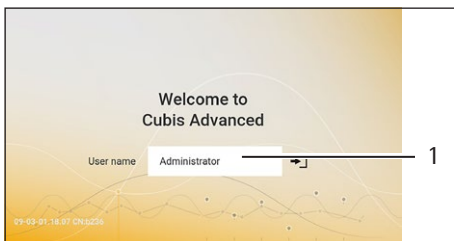

8.3 Leveling the Device

8.3.1 Level Device with Motorized Leveling Feet

Leveling compensates any inclines at the device's installation site. If leveling is necessary: The [Leveling] button appears in the weighing display and a message appears in the Status Center.

Procedure

- ▶ If the weighing display is displayed: Press the [Leveling] button.
- ▶ When the Status Center is displayed: Press the [Level] button.
- ▷ The Leveling Wizard opens.
- ▶ Follow the wizard's instructions.

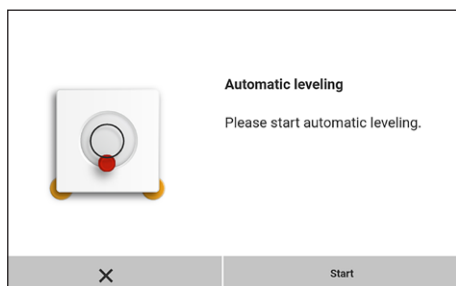

8.4 Activating Applications and Adding a Task

8.4.1 Activating Applications

All applications from the QAPP package "Essentials" are activated for the device at the factory. Additional applications may be activated in the QAPP center.

Procedure

- ▶ Open Task Management.
- ▶ Press the [QAPP center] button.
- ▷ An overview of all available QAPP packages is displayed.
- ▶ Select the desired software application package e.g. pharmaceuticals.
- ▶ To scroll through the contents of a displayed QAPP package: Swipe the contents of the QAPP package upwards or downwards.

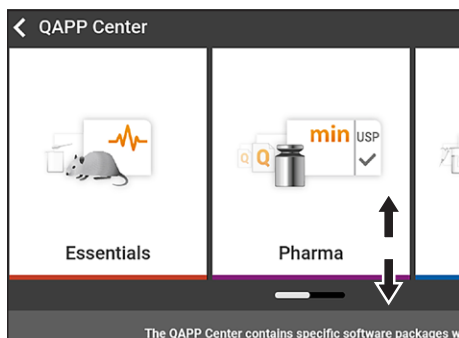

- ▶ Select the desired QAPP package:
- ▷ A list of all the applications contained in the QAPP package is displayed.
- ▶ If the selected QAPP package is to be approved with all the applications it contains or all QAPP packages are to be approved:
 - ▶ Press the [License] button.
 - ▷ The input field for the license key appears.
 - ▶ If an additional cost is associated with the QAPP package: Enter the license key in the entry field and press the [OK] button.
 - ▶ If no additional cost is associated with the QAPP package: Press the [OK] button.

- ▶ If an individual application from the displayed QAPP package is to be activated:
 - ▶ Press the desired application.
 - ▷ A display opens containing details about the selected application.
 - ▶ Press the [License] button.
 - ▷ The input field for the license key appears.
 - ▶ If an additional cost is associated with the application: Enter the license key in the entry field and press the [OK] button.
 - ▶ If no additional cost is associated with the application: Press the [OK] button.

8.4.2 Adding an Application to a Task

Applications must be added to a task so that they can run.

Procedure

- ▶ Open Task Management.
- ▶ Press the [New] button.
- ▷ A list of all activated applications is displayed.
- ▶ To select an application: Press the desired application.
- ▷ The wizard for creating a new task starts.
- ▶ Follow the wizard's instructions in the operating display.

8.5 Adding Weighing and Print Profiles to a Task

To be able to use a weighing or print profile: Add a weighing or print profile to a task. Weighing and print profiles can be configured in the Settings menu.

Procedure

- ▶ Open the task.
- ▶ Create or edit a task.

8.6 Preparing Weighings

The device must be prepared before every weighing.

Procedure

- ▶ Level the device.
- ▶ Zero the device. In order to do so, press the [Zero] button.
- ▶ If the device **cannot** be zeroed: Remove the sample to be weighed and re-zero the device.
- ▶ Calibrate the device.

8.7 Weighing

NOTICE

Chemicals may damage the device or accessories!

Chemicals can attack the device or the connected accessories internally and externally. This may damage the device and accessories.

- ▶ Use appropriate containers when weighing chemicals.

Procedure

- ▶ Start a task with weighing function.
- ▶ Zero the device. In order to do so, press the [Zero] button.
- ▶ If below-balance weighing is being carried out: Suspend the sample on the hook for below-balance weighing, e.g. with a wire.
- ▶ If a container is being used for the sample:
 - ▶ Place the container on the weighing pan.
 - ▶ Tare the device. In order to do so, press the [Tare] button.
 - ▶ Place the sample in the container or fill the container.
- ▶ If **no** container is used for the sample and **no** below-balance weighing is being carried out: Place the sample on the weighing pan.
- ▶ Once the weight value is displayed in black and the weighing unit is displayed: Read off the measured value.

8.8 Overview of Calibration, Adjustment, and Linearization

During calibration, a calibration weight is used to determine how much the displayed value deviates from the actual value. This deviation is compared against a preset target value. The subsequent adjustment eliminates this deviation. During linearization, the deviation of the values from the ideal characteristic curve is corrected.

Calibration and adjustment must be performed regularly:

- Daily, every time the device is switched on
- After every leveling
- After changing the ambient conditions (temperature, humidity, or air pressure)
- After setting the device up at a new installation site

Calibration and adjustment may be performed in different ways:

- Adjusting with the isoCAL function
- Internal or external calibration or adjustment



Only internal adjustment/calibration is possible for all conformity-assessed devices in legal metrology.

8.9 Adjusting with the isoCAL Function

The device can be automatically internally calibrated and adjusted using the isoCAL function.

Requirements

- The device is **not** located in the menu.
- Alphanumeric inputs are **not** active.
- The load on the weighing pan remains unchanged for 2 minutes.
- The load on the weighing pan amounts to no more than 2% of the maximum load.
- The device does **not** register an input for 2 minutes.

If all requirements for starting the isoCAL function are met and one of the following conditions occurs: The isoCAL function is automatically triggered.

Possible conditions are:

- The ambient temperature has changed since the last adjustment/calibration.
- The interval time was exceeded (interval time, see Chapter "15.9 isoCAL Function", page 80).
- The device has been leveled.
- The device has been disconnected from the power supply since the last adjustment/calibration (only for conformity-assessed models).

Procedure

- ▶ If the isoCAL automatic start function is set and the [isoCAL] button is displayed as the predominant button in the operating display:
 - ▶ Wait until the isoCAL function starts automatically.
 - ▷ In the operating display, a time display counts down to 0.
 - ▷ If **no** load change or **no** operation takes place on the device before the expiration of the time display: The isoCAL function starts.
- ▶ If the isoCAL manual start function is set and the [isoCAL] button is displayed as the predominant button in the operating display:
 - ▶ Press the [isoCAL] button.
 - ▶ If information is displayed stating that the weighing pan is loaded: Unload the weighing pan.
 - ▷ The isoCAL function starts.
- ▷ If the isoCAL function is complete: The device confirms the completion of the calibration/adjustment process with an acoustic signal, and the calibration report is displayed.
- ▶ To close the calibration report and return to the previous display: Press the [OK] button.

8.10 Internally Calibrating and Adjusting the Device

Requirements

The weighing pan is unloaded.

Procedure

- ▶ Open the main menu.
- ▶ Press the "Internal Adjustment" task.
- ▷ The internal calibration/adjustment function is executed.
- ▷ If automatic leveling is set for a model with motorized adjusting feet: The device levels itself automatically.
- ▷ If the calibration/adjustment function is complete: The device confirms the completion of the calibration/adjustment process with an acoustic signal, and the calibration report is displayed.
- ▶ To close the calibration report and return to the main menu: Press the [OK] button.

8.11 Weighing and Printing with ID Marking

8.11.1 Saving Values for Printouts

Every lot and every sample can be assigned an ID number. The ID numbers are saved in the print memory and exported during the printing process.

Requirements

The prompt for the lot IDs and sample IDs is activated for the "Weighing" task.

Procedure

- ▶ Open the main menu.
- ▶ Start the "Weighing" task: To do so, tap on the task.
- ▷ The input field for the lot ID is displayed.
- ▶ If a barcode scanner is connected to the device: Enter the lot ID in the entry field or scan using the barcode scanner.
- ▶ If **no** barcode scanner is connected to the device: Type the lot ID into the entry field.
- ▶ Press the [OK] button.
- ▷ The weighing display is displayed.
- ▶ Zero the device. In order to do so, press the [Zero] button.
- ▶ Place the sample on the weighing pan.
- ▶ Press the [Confirm] button.
- ▷ The input field for the sample ID is displayed.
- ▶ Type the sample ID into the entry field.
- ▶ Press the [OK] button.
- ▷ The [Print memory] button appears in the operating display.
- ▷ The weight value and entered IDs are saved.
- ▶ If additional values are to be saved:
 - ▶ Remove the sample being weighed.
 - ▶ Place the next sample on the weighing pan and press the [Confirm] button.
 - ▶ Type the sample ID into the entry field.
 - ▶ Press the [OK] button.

8.11.2 Marking Saved Values as Invalid

Procedure

- ▶ Press the [Print Memory] button.
- ▷ The print memory opens and a list of all saved values is displayed.
- ▶ Press the [Edit] button.
- ▶ Press the desired items.
- ▷ An overview of all data to be printed is displayed for the selected items.
- ▶ Press the [Yes] button.
- ▶ If a reason for the invalidity of the value needs to be displayed on the printout: Enter a reason in the entry field and press the [OK] button.
- ▶ If **no** reason for the invalidity of the value needs to be displayed on the printout: Press the [No] button.

8.11.3 Marking Saved Values as Valid

Procedure

- ▶ Press the [Print Memory] button.
- ▷ The print memory opens and a list of all saved values is displayed.
- ▶ Press the items which are desired to be marked as invalid.
- ▷ An overview of all data to be printed is displayed for the selected items.
- ▶ Press the [Yes] button.

8.11.4 Printing Saved Values

Procedure

- ▶ Press the [Print Memory] button.
- ▷ The print memory opens and a list of all saved values is displayed.
- ▶ To start the print process using the print profile embedded in the current task: Press the [Print] button.
- ▷ A PDF file is produced and sent to the printer defined in the print profile. For two print profiles with different connectors: The print processes will be started in succession.

8.11.5 Exiting the Task

Procedure

- ▶ Press the [Exit] or [Menu] button.
- ▷ If additional values are to be saved in the print memory:
 - ▷ A dialog for prematurely ending the task appears.
 - ▶ To return to the weighing display and print the saved values: Tap on the [Yes] button and print the saved values.
 - ▶ To exit the task and delete the saved values from the print memory: Press the [No] button.
- ▷ The task ends and the main menu is displayed.

8.12 Viewing the Data Storage Device

The data storage device stores weight values with date, time, and process number. The content of the data storage device can be searched and sorted using a filter. The data storage device has a ring buffer. This means that the oldest data records can be overwritten by new ones. The data storage device is designed for a specific number of data records (for the number of data records see Chapter "15.10 Data Storage Device", page 81).

The user alone is responsible for making sure that there is sufficient storage capacity and the saved weighed values are present.

M

The data storage device is verifiable. The proper functioning of the data storage device must be ensured for verification by saving and checking some values.

Procedure

- ▶ Open the "Settings/Device Settings/Device Information" menu.
- ▶ Press the "View data storage device" menu entry.
- ▷ A list of all the values saved in the data storage device is displayed.
- ▶ If only the values for a desired date need to be displayed:
 - ▶ Press the [Filter] button.
 - ▶ Type the desired date into the entry field.
 - ▶ To filter the list with the date entered: Press the [OK] button.
- ▶ If the list needs to be searched for a particular ID:
 - ▶ Press the [Search] button.
 - ▶ Type the desired ID into the entry field.
 - ▶ To start the search with the entered ID: Press the [OK] button.

8.13 Running Applications (Examples)

8.13.1 Executing the "Unit Change" Function

The "Unit Change" function enables the user to switch between the different units and resolutions defined in the weighing profile of the active task. The units and resolutions can be set at the beginning of the weighing process.

Procedure

- ▶ Start the desired task.
- ▶ Press the [Unit Change] button.
- ▷ All units defined in the weighing profile for the active task are displayed in a list.
- ▷ All resolutions for the weight value defined in the weighing profile for the active task are displayed in a list.
- ▶ Press the desired unit.
- ▶ To set the resolution for the selected unit: Press the desired resolution.
- ▶ To confirm the selection and return to the weighing display: Press the [OK] button.
- ▷ The current weight value is displayed in the selected unit and resolution.

8.13.2 Running the "Statistics" Application

The "Statistics" application saves up to 100 weight values and evaluates these statistically.

The following values are saved and exported by the statistics application:

- Number of components
- Mean value
- Standard deviation
- Variation coefficient
- Sum of all values
- Lowest value (minimum)
- Highest value (maximum)
- Spread: Difference between maximum and minimum

The "Statistics" application can be combined with the following functions:

- Unit Change, only available in the weighing display, before saving the initial weight value
- ID marking
- Automatic taring

Procedure

- ▶ Open the main menu.
- ▶ Start the task for the "Statistics" application.
- ▶ Zero the device.
- ▶ Place the sample on the weighing pan.
- ▶ To start the recording of the statistics: Press the [Confirm] button on the keypad.
- ▷ The current weight value is saved and the device is automatically tared.
- ▶ To save the next value: Place a new sample on the weighing pan and press the [Confirm] button.
- ▶ To display an overview of the saved data: Press the [Report] button.
- ▶ To print the current statistics: Press the [Print] button.
- ▶ To exit the current statistics, and to delete the saved values: Press the [Exit] button.

9 Cleaning and Maintenance

9.1 Preparing the Device

Procedure

- ▶ Turn the device off.
- ▶ Disconnect the device from the power supply. To do so, disconnect the power supply cable from the wall outlet.
- ▶ Remove the weighing pan and all associated components from the weighing module, e.g. shield ring, pan support.

9.2 Cleaning the Device

NOTICE

Corrosion or damage to the device due to unsuitable cleaning agents!

- ▶ Do **not** use corrosive, chloride-containing, or aggressive cleaning agents.
 - ▶ Do **not** use cleaning agents that contain abrasive ingredients, e.g. scouring agents, steel wool.
 - ▶ Do **not** use solvent-based cleaning agents.
 - ▶ Check whether the cleaning agents used are compliant materials (see Chapter "15.4 Materials", page 76).
 - ▶ Make sure that cleaning materials, such as cloths, are only slightly damp.
-

Procedure

- ▶ **NOTICE** Malfunction or damage to the device due to the ingress of moisture or dust!
 - ▶ Remove dust and powdery sample residue with a brush or hand-held vacuum cleaner.
- ▶ **NOTICE** Corrosion or damage to the weighing pan due to unsuitable cleaning agents
 - ▶ Wipe down the weighing pan and the shield ring with a cleaning agent and a cloth. The cleaning agent must be suitable for stainless steel and titanium.
- ▶ Wipe the associated components of the weighing pan with a brush or a damp cleaning cloth, e.g. shield ring, pan support.
- ▶ Wipe the device housing with a damp cloth. For more severe contamination, use a mild soap solution.

Tip

We recommend cleaning the weighing pan on a regular basis, e.g. weekly. Do **not** allow deposits to form on the weighing pan.

Protective oil may be applied to the weighing pan for additional protection. The protective oil must be suitable for stainless steel and titanium.

9.3 Assembling and Connecting the Device

Procedure

- ▶ Replace the weighing pan and the associated components on the weighing module (see Chapter "5.7 Positioning the Weighing Pan and Associated Components", page 39).
- ▶ Re-connect the device to the power supply (see Chapter 6.2, page 40).

9.4 Maintenance Schedule

Interval	Component	Action	Chapter, page
Monthly to every 2 years, depending on the operating conditions	Device	Contact Sartorius Service	17, 84

9.5 Performing a Software Update

A software update can be installed from a USB mass storage device using the device's USB-A connection. A software update can extend or change functionality.

Requirements

- The device is switched on.
- The software update is saved on a USB mass storage device.

Procedure

- ▶ Download the software update from the Sartorius website onto the USB mass storage device.
- ▶ If this relates to a zip file: Unzip the software update on the stick. The files must be saved at root level. The files must **not** be set aside in a folder.
- ▶ Insert the USB mass storage device with the software update into one of the device's USB-A connection sockets.
- ▶ Select the "Update Firmware" menu entry in the "Settings/Device Maintenance" menu.
- ▶ Select "USB stick" as the connector.
- ▷ The software update takes approx. 3 minutes.
- ▷ Once the software update is complete: The software version number is updated in the login display.

9.6 Performing a QAPP Center Update

The QAPP center update can be installed from a USB mass storage device using the device's USB-A connection.

Requirements

- The device is switched on.
- The QAPP center update is saved on a USB mass storage device.

Procedure

- ▶ Download the QAPP center update from the Sartorius website onto the USB mass storage device.
- ▶ If this relates to a zip file: Unzip the software update on the stick. The files must be saved at root level. The files must **not** be set aside in a folder.
- ▶ Insert the USB mass storage device with the software update into one of the device's USB-A connection sockets.
- ▶ Select the "Update Firmware" menu entry in the "Settings/Device Maintenance" menu.
- ▶ Select "USB stick" as the connector.
- ▶ Tap on the desired update.
- ▶ Once the software update is complete: Confirm successful installation with the [OK] button.

10 Malfunctions

10.1 Warning Messages

Warning message	Fault	Cause	Remedy	Chapter, page
Disp.Err.	The value to be output cannot be shown in the operating display.	The data to be displayed is not compatible with the set display format.	Adjust the display settings in the menu, e.g. resolution, unit, decimal places.	
High	The device is overloaded.	The device's maximum weighing capacity has been exceeded.	Reduce the applied weight to below the device's maximum weighing capacity.	15.7, 77
Low	The modulation of the weighing converter inside the weighing module is too low.	No weighing pan has been placed on the balance. A previously forgotten weight was removed after starting the device.	Insert the weighing pan into the device and switch the device off and on again.	
Com.Err.	The device is not receiving any weight values.	No communication exists between the display and control unit and the weighing module.	Wait until the display and control unit restores the communication with the weighing module. If the problem occurs again: Contact Sartorius Service.	17, 84

10.2 Troubleshooting

Fault	Cause	Remedy	Chapter, page
The operating display is blank.	The device is disconnected.	Check the connection to the power supply.	6.2, 40
	The AC adapter is not connected.	Connect the power supply cable to the power supply.	6.2, 40
The displayed weight value changes constantly.	The installation site is unstable.	Adjust the parameters in the "Environment Monitoring" Submenu.	7.4.3, 44
		Change the installation site.	5.2, 35
	A foreign object is positioned between the weighing pan and the housing.	Remove the foreign object.	
The weight readout displayed by the device is obviously wrong.	The device was not calibrated.	Calibrate the device.	8.7, 61
	The device was not tared before weighing.	Tare the device.	

11 Decommissioning

11.1 Decommissioning the Device

Procedure

- ▶ Turn the device off.
- ▶ Disconnect the device from the power supply.
- ▶ Disconnect the device from all connected devices and all accessories, e.g. printer.
- ▶ Clean the device (see Chapter 9.2, page 67).
- ▶ If below-balance weighing has been set up:
 - ▶ Remove the hook for below-balance weighing from the thread (1).
 - ▶ Insert the hook for below-balance weighing back into its retainer on the underside of the weighing module.
 - ▶ Re-insert the cover (2) of the below-balance weighing equipment.

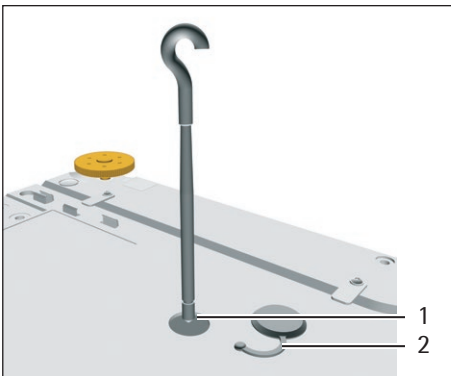

12 Transport

12.1 Transporting the Device

Procedure



- ▶ Only lift the device by its base.
- ▶ When lifting and transporting, ensure that **no** personnel or objects are in the way.
- ▶ Get help from additional persons when lifting and transporting the device.
- ▶ Use suitable conveyance devices, e.g. trolleys, for long transport routes.

13 Storage and Shipping

13.1 Storage

Procedure

- ▶ Turn the device off.
- ▶ Disconnect the device from the power supply.
- ▶ Disconnect the device from all connected devices and all accessories, e.g. printer.
- ▶ Clean the device (see Chapter 9.2, page 67).
- ▶ Store the device according to the ambient conditions (see Chapter 15.2, page 74).

13.2 Returning Device and Parts

Defective devices or device components can be returned to Sartorius. Returned devices must be clean, decontaminated, and properly packed, e.g. in the original packaging.

Transport damage as well as measures for subsequent cleaning and disinfection of the device or device components by Sartorius shall be charged to the sender.

WARNING

Risk of injury due to contaminated devices!

Devices contaminated with hazardous materials [nuclear, biological, or chemical (NBC)] will **not** be accepted for repair or disposal.

- ▶ Observe the information on decontamination (see Chapter 14.1, page 73).
-

Procedure

- ▶ Switch off the device.
- ▶ Disconnect the device from the power supply.
- ▶ Disconnect the device from all connected devices and all accessories, e.g. printer.
- ▶ Clean the device.
- ▶ Contact Sartorius Service for instructions on how to return devices or device components (please refer to www.sartorius.com for return instructions).
- ▶ Pack the device and the device components properly for return, e.g. in the original packaging.

14 Disposal

14.1 Information on Decontamination

The device does **not** contain any hazardous materials that would necessitate special disposal actions.

Contaminated samples used during the process are potentially hazardous materials that could cause biological or chemical hazards.

If the device has come into contact with hazardous substances: Steps must be taken to ensure proper decontamination and declaration. The operator is responsible for adhering to local government regulations on the proper declaration of transport and disposal and the proper disposal of the device.

WARNING

Risk of injury due to contaminated devices!

Devices contaminated with hazardous materials (NBC contamination) will **not** be accepted by Sartorius for repair or disposal.

14.2 Disposing of Device and Parts

14.2.1 Information on Disposal

The device and the device accessories must be disposed of properly by disposal facilities.

A lithium cell battery, type CR2032, is installed inside the device. Batteries must be disposed of properly by disposal facilities.

The packaging is made of environmentally friendly materials that can be used as secondary raw materials.

14.2.2 Disposal

Requirements

The device has been decontaminated.

Procedure

- ▶ Dispose of the device. Follow the disposal instructions on our website (www.sartorius.com).
- ▶ Inform the disposal facility that there is a lithium cell battery, type CR2032, installed inside the device.
- ▶ Dispose of the packaging in accordance with local government regulations.

15 Technical Data

15.1 Dimensions and Weight

	Unit	Value
Dimensions (L x W x H)	mm	470 x 240 x 95
Weighing pan size	mm	206 x 206
Weight, approx.	kg	5.4

15.2 Ambient Conditions

15.2.1 Installation Site

	Unit	Value
Installation site		
Standard laboratory rooms		
Installation site according to IEC 60259-1, maximum altitude above sea level	m	3000
For indoor use only		
Temperature		
In operation	°C	+5 – +40
In operation for conformity-assessed devices: See information on the device's ID plate		
During storage and transport	°C	-20 – +60
Relative humidity		
At temperatures of up to 31°C	%	80
Then linear decrease from 80% at 31°C to 50 % at 40°C		
No heat from heating systems or direct sunlight		
No drafts from open windows, AC systems, or doors		
No vibrations		
No "heavy traffic" areas (personnel)		
No electromagnetic fields		
No dry air		

15.2.2 Ambient Temperature for the isoCAL Function

		MCA14202S	MCA14202P	MCA10202S	MCA8202S
	Unit	Value	Value	Value	Value
Scope of application as per Directive 2014/31/EU					
With isoCAL function	°C	+10 – +30	+10 – +30	+10 – +30	+10 – +30
Without isoCAL function	°C	+17 – +27	+17 – +27	+17 – +27	+10 – +30

		MCA6202S	MCA6202P	MCA4202S	MCA2202S
	Unit	Value	Value	Value	Value
Scope of application as per Directive 2014/31/EU					
With isoCAL function	°C	+10 – +30	+10 – +30	+10 – +30	+10 – +30
Without isoCAL function	°C	+10 – +30	+10 – +30	+10 – +30	+10 – +30

		MCA1202S	MCA12201S	MCA8201S	MCA5201S
	Unit	Value	Value	Value	Value
Scope of application as per Directive 2014/31/EU					
With isoCAL function	°C	+10 – +30	+10 – +30	+10 – +30	+10 – +30
Without isoCAL function	°C	+10 – +30	+10 – +30	+10 – +30	+10 – +30

15.2.3 Protection Class

	Value
IP protection according to IEC 60529-1	IP 54

15.3 Power Supply

15.3.1 Device

Only by Sartorius AC adapter YEPS03-15V0

15.3.2 Power Supply Unit

	Unit	Value
Item No.		YEPS03-15V0
Primary		
AC voltage	V	100–240 (±10%)
Frequency	Hz	50–60 (±5%)
Current consumption, maximum	A	1.0
Secondary		
DC voltage at 2 A output current	V	14.25–15.75
Power, maximum	W	30
Short circuit protection: Electronic		
Protection class according to IEC 62368-1		I

	Unit	Value
Pollution level according to IEC 61010-1		2
Overvoltage category according to IEC 606641-1		II
Installation site according to IEC 62368-1, maximum altitude above sea level	m	5000
Temperature		
In operation	°C	0 – +40
During storage and transport	°C	-20 – +80
Connector for mains connection according to IEC 60320-1/C14: 3-pin		
Power supply cable		
Power supply cable according to IEC 60320-1/C14: Country-specific, 3-pin, two-sided plug		
Other data: See label on AC adapter		

15.3.3 Safety of Electrical Equipment

According to EN 61010-1/IEC 61010-1 Safety requirements for electrical equipment for measurement, control, and laboratory use – Part 1: General Requirements

15.3.4 Electromagnetic Compatibility

Interference resistance

Suitable for use in industrial areas

Transient emissions

Class B

Suitable for use in residential areas and areas that are connected to a low voltage network that also supplies residential buildings.

15.4 Materials

Housing: Die-cast aluminum, plastic PBT, Optiwhite float glass and stainless steel 1.4401/1.4404, PA handles, aluminum trim

Control unit: Die-cast aluminum, painted, float glass and plastic PBT, PP

15.5 Integrated Clock

	Unit	Value
Maximum deviation per month (RTC)	s	30

15.6 Backup Battery

	Unit	Value
Lithium battery, type CR2032		
Service life at room temperature, minimum	Years	10

15.7 Metrological Data

15.7.1 Models MCA14202S | MCA14202P | MCA10202S | MCA8202S

		MCA14202S	MCA14202P	MCA10202S	MCA8202S
	Unit	Value	Value	Value	Value
Scale interval (d)	mg	10	10 20 50	10	10
Maximum capacity (Max)	g	14200	3500 7000 14200	10200	8200
Repeatability at 5% load					
Standard deviation of the load values, tolerance	mg	10	10	7	7
Standard deviation of the load values, typical value	mg	5	5	5	4
Repeatability at approx. maximum capacity					
Standard deviation of the load values, tolerance	mg	10	10	7	7
Standard deviation of the load values, typical value	mg	5	5	5	4
Linearity deviation					
Tolerance	mg	30	50	20	20
Typical value	mg	10	20	6	6
Deviation when load is off-center, positions according to OIML R76					
Test weight	g	5000	5000	5000	5000
Tolerance	mg	20	40	20	30
Typical value	mg	10	10	10	10
Sensitivity drift between +10°C and +30°C	ppm/K	1.5	1.5	1.5	2
Tare maximum capacity: Less than 100 % of maximum capacity					
Accuracy class according to Directive 2014/31/EU		I	I	I	II
Verification scale interval (e) according to Directive 2014/31/EU	g	0.1	0.1	0.1	0.1
Minimum load (Min) according to Directive 2014/31/EU	g	1	1	1	0.5
Minimum initial weighing according to USP (United States Pharmacopeia), Chap. 41					
Optimum minimum initial weighing	g	8.2	8.2	8.2	8.2
Typical minimum initial weighing	g	8.2	8.2	8.2	8.2
Typical stabilization time	s	0.8	0.8	0.8	1
Typical measurement time	s	1.5	1.5	1.5	1.5

15.7.2 Models MCA6202S | MCA6202P | MCA4202S | MCA2202S

		MCA6202S	MCA6202P	MCA4202S	MCA2202S
	Unit	Value	Value	Value	Value
Scale interval (d)	mg	10	10 20 50	10	10
Maximum capacity (Max)	g	6200	1500 3000 6200	4200	2200
Repeatability at 5% load					
Standard deviation of the load values, tolerance	mg	7	7	7	7
Standard deviation of the load values, typical value	mg	4	4	4	4
Repeatability at approx. maximum capacity					
Standard deviation of the load values, tolerance	mg	7	40	7	7
Standard deviation of the load values, typical value	mg	4	15	4	4
Linearity deviation					
Tolerance	mg	20	50	20	20
Typical value	mg	6	20	6	6
Deviation when load is off-center, positions according to OIML R76					
Test weight	g	2000	2000	2000	1000
Tolerance	mg	20	30	30	20
Typical value	mg	10	30	10	10
Sensitivity drift between +10°C and +30°C	ppm/K	2	2	2	2
Tare maximum capacity: Less than 100% of maximum capacity					
Accuracy class according to Directive 2014/31/EU		II	II	II	II
Verification scale interval (e) according to Directive 2014/31/EU	g	0.1	0.1	0.1	0.1
Minimum load (Min) according to Directive 2014/31/EU	g	0.5	0.5	0.5	0.5
Minimum initial weighing according to USP (United States Pharmacopeia), Chap. 41					
Optimum minimum initial weighing	g	8.2	8.2	8.2	8.2
Typical minimum initial weighing	g	8.2	8.2	8.2	8.2
Typical stabilization time	s	1	1	1	0.8
Typical measurement time	s	1.5	1.5	1	1

15.7.3 Models MCA1202S | MCA12201S | MCA8201S | MCA5201S

		MCA1202S	MCA12201S	MCA8201S	MCA5201S
	Unit	Value	Value	Value	Value
Scale interval (d)	mg	10	100	100	100
Maximum capacity (Max)	g	1200	12200	8200	5200
Repeatability at 5% load					
Standard deviation of the load values, tolerance	mg	7	50	50	50
Standard deviation of the load values, typical value	mg	4	20	20	20
Repeatability at approx. maximum capacity					
Standard deviation of the load values, tolerance	mg	7	50	50	50
Standard deviation of the load values, typical value	mg	4	20	20	20
Linearity deviation					
Tolerance	mg	20	100	100	100
Typical value	mg	6	30	30	20
Deviation when load is off-center, positions according to OIML R76					
Test weight	g	500	5000	5000	2000
Tolerance	mg	20	200	200	200
Typical value	mg	10	100	100	100
Sensitivity drift between +10°C and +30°C	ppm/K	2	4	4	4
Tare maximum capacity: Less than 100% of maximum capacity					
Accuracy class according to Directive 2014/31/EU		II	II	II	II
Verification scale interval (e) according to Directive 2014/31/EU	g	0.1	1	1	1
Minimum load (Min) according to Directive 2014/31/EU	g	0.5	5	5	5
Minimum initial weighing according to USP (United States Pharmacopeia), Chap. 41					
Optimum minimum initial weighing	g	8.2	82	82	82
Typical minimum initial weighing	g	8.2	82	82	82
Typical stabilization time	s	0.8	0.8	0.8	0.8
Typical measurement time	s	1	1	1	1

15.8 Recommended Calibration Weight

		MCA14202S	MCA14202P	MCA10202S	MCA8202S
	Unit	Value	Value	Value	Value
External test weight	g	14000	14000	10000	7000
Recommended accuracy class		E2	E2	E2	E2

		MCA6202S	MCA6202P	MCA4202S	MCA2202S
	Unit	Value	Value	Value	Value
External test weight	g	5000	5000	3000	1500
Recommended accuracy class		E2	E2	E2	E2

		MCA1202S	MCA12201S	MCA8201S	MCA5201S
	Unit	Value	Value	Value	Value
External test weight	g	700	12000	8000	5000
Recommended accuracy class		E2	F1	F1	F1

15.9 isoCAL Function

15.9.1 Models MCA14202S | MCA14202P | MCA10202S

	Unit	Value
isoCAL is triggered by the following criteria:		
In the event of a temperature change	K	1.5
After a time interval	h	12
After successful leveling		

15.9.2 Models MCA8202S | MCA6202S | MCA6202P | MCA4202S | MCA2202S | MCA1202S

	Unit	Value
isoCAL is triggered by the following criteria:		
In the event of a temperature change	K	2
After a time interval	h	12
After successful leveling		

15.9.3 Models MCA12201S | MCA8201S | MCA5201S

	Unit	Value
isoCAL is triggered by the following criteria:		
In the event of a temperature change	K	4
After a time interval	h	12
After successful leveling		

15.10 Data Storage Device

	Value
Maximum number of data records	150000

15.11 Interfaces

15.11.1 Specifications for the COM-RS232 Interface

Type of interface: Serial interface
Interface operation: Full duplex
Level: RS232
Connection: D-sub connector, 9-pin
Pin assignment

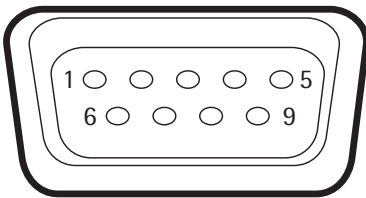

- Pin 1: **Not** assigned
- Pin 2: Data output (TxD)
- Pin 3: Data input (RxD)
- Pin 4: **Not** assigned
- Pin 5: Internal ground
- Pin 6: **Not** assigned
- Pin 7: Clear to Send (CTS)
- Pin 8: Request to Send (RTS)
- Pin 9: **Not** assigned

15.11.2 Specifications for the USB-A Interface

Communication: USB host (master)
Connectable devices: Sartorius printers, USB memory sticks, USB barcode scanners, USB keyboards

15.11.3 Specifications for the USB-B Interface

Communication: USB device (slave)
Type of interface: Virtual serial interface (virtual COM-port, VCP) and "PC direct" communication

16 Accessories

16.1 Accessories

This table contains an excerpt of the accessories that can be ordered. For information on other products, contact Sartorius.

16.1.1 Printers and Communication

Item	Quantity	Order number
Thermal transfer thermal printer for GLP/GMP printouts on continuous paper and labels	1	YDP30
Thermal transfer thermal network printer with Ethernet connection for GLP/GMP printouts on continuous paper and labels	1	YDP30-NET
Wireless nano USB adapter for company network or independent Wi-Fi network, e.g., operation with a Sartorius network printer YDP30-NET (only for Europe)	1	YWLAN01MS
Wireless nano router, e.g., for Sartorius network printer YDP30-NET for operation in an independent Wi-Fi network (only for Europe)	1	YWLAN02MS
Display cable, 3 m, for separate installation of display and weighing units, installation by Sartorius Service or at the factory	1	VF4754
Installation of display cable, 3 m, for separate installation of display and weighing units	1	VF4016
RS232C connection cable, 9-pin, 3 m, for connection to a PC with 9-pin COM interface	1	VF4761
USB QR barcode scanner	1	YBR05
Sartorius Wedge, software for data communication between the PC and device	1	YSW02

16.1.2 Displays and Input/Output Elements

Item	Quantity	Order number
MCE operating display with color TFT display and touch screen	1	69MS0128
Motion sensor for triggering a maximum of 4 functions via gesture control, selection via menu	1	YHS02MS

16.1.3 Special Applications

Item	Quantity	Order number
Grid pan for models with a scale interval of 10 mg or 100 mg for weighing in laboratory hoods, safety barriers, and workbenches, reduced wind attack surface of the weighing pan, replaces standard weighing pan	1	YWP07MS

16.1.4 Weighing Tables

Item	Quantity	Order number
Weighing table		
Made from synthetic stone, with vibration dampening	1	YWT03
Made from wood and synthetic stone	1	YWT09
Wall console	1	YWT04

16.1.5 Weighing Accessories

Item	Quantity	Order number
Weighing scoop made from chrome-nickel steel, L 90 mm x W 32 mm x H 8 mm	1	641214
Stand for weighing modules with scale intervals of 10 mg 100 mg for raising the control units		YDH03MS

17 Sartorius Service

Sartorius Service is available for queries regarding the device. For information about the service addresses, services provided, or to contact a local representative, please visit the Sartorius website (www.sartorius.com).

When contacting Sartorius Service with questions about the system or in the event of malfunctions, be sure to have the device information, e.g. serial number, hardware, firmware, and configuration, to hand. Consult the information on the manufacturer's ID label and in the "General Device Information" menu (see Chapter "4.14 Menu Structure", page 28).

18 Conformity Documents

18.1 EU Declaration of Conformity

The attached Declaration of Conformity hereby confirms compliance of the device with the directives cited.



The declaration of conformity supplied here is for conformity-assessed (verified) balances for use in the EEA. Please keep it in a safe place.



Original



sartorius

EG-/EU-Konformitätserklärung EC / EU Declaration of Conformity

Hersteller
Manufacturer

Sartorius Lab Instruments GmbH & Co. KG
37070 Goettingen, Germany

erklärt in alleiniger Verantwortung, dass das Betriebsmittel
declares under sole responsibility that the equipment

Geräteart
Device type

Elektronische Präzisions-, Milligramm-, Analysen-, Semimikro-, Mikro-Klein- und Hochlastwaage |
Netzgerät | Handsensor | Klimamodul
*Electronical Precision, Milligram, Analytical, Semi micro, Micro-Small, and High-Capacity Balance | Power Supply |
Hand sensor | Climatic module*

Baureihe
Type series

MCAvw-2x-y, MCEvw-2x-y | YEPS03-15V0 | YHS02MS | YCM20MC, YCM20MC-DAKKS
v = 2.7, 3.6, 6.6, 10.6, 124, 125, 224, 225, 323, 324, 524, 623, 1202, 1203, 2202, 2203, 3203, 4202,
5201, 5202, 5203, 6202, 8201, 8202, 10202, 11201, 12201, 14202, 20201, 32202, 36200, 36201,
50201, 70200, 70201;
w = S, P; x = S00, S01, CEU, CFR, CCN, OBR, OIN, ORU, OJP; y = A, E, F, I, M, O, R, U

in der von uns in Verkehr gebrachten Ausführung allen einschlägigen Bestimmungen der folgenden
Europäischen Richtlinien - einschließlich deren zum Zeitpunkt der Erklärung geltenden Änderungen -
entspricht und die anwendbaren Anforderungen folgender harmonisierter Europäischer Normen -
einschließlich deren zum Zeitpunkt der Erklärung geltenden Änderungen - erfüllt:

*in the form as delivered fulfils all the relevant provisions of the following European Directives -
including any amendments valid at the time this declaration was signed - and meets the applicable
requirements of the harmonized European Standards including any amendments valid at the time this
declaration was signed - listed below:*

2014/30/EU

Elektromagnetische Verträglichkeit
Electromagnetic compatibility
EN 61326-1:2013

2006/42/EG
2006/42/EC

Maschinen
Machines
EN ISO 12100:2010, EN 61010-1:2010*

2011/65/EU

Beschränkung der Verwendung bestimmter gefährlicher Stoffe in Elektro- und Elektronikgeräten (RoHS)
Restriction of the use of certain hazardous substances in electrical and electronic equipment (RoHS)
EN 50581:2012

Die Person, die bevollmächtigt ist, die technischen Unterlagen zusammenzustellen:

The person authorised to compile the technical file:

Sartorius Lab Instruments GmbH & Co. KG
Electronics & Product Compliance
37070 Goettingen, Germany

Sartorius Lab Instruments GmbH & Co. KG
Goettingen, 2019-07-01

Dr. Reinhard Baumfalk
Head of Product Development
Lab Products and Services Division

Dr. Dieter Klausgrete
Senior Scientist Certification Management

*: angewandte, jedoch für Maschinen nicht harmonisierte Norm /
applied standard, which however is not harmonized for machines

Doc: 2369814-01 SLI18CE001-01.de,en 1 / 1 PMF: 2369813 OP-113_fo1_2015.10.12



Certificate: 70185847
Project: 70185847

Master Contract: 167555
Date Issued: 2018-09-24

APPLICABLE REQUIREMENTS

CSA Standards:

CAN/CSA-C22.2 No. 61010-1-12 - Safety Requirements for Electrical Equipment for Measurement, Control, and Laboratory Use, Part 1: General Requirements

UL Standards:

UL Std. No. 61010-1 (3rd Edition) - Safety Requirements for Electrical Equipment for Measurement, Control, and Laboratory Use - Part 1: General Requirements

CONDITIONS OF ACCEPTABILITY

- (1) Equipment is intended to be used with power supply FSP Group Inc, Model FSP030-DGAN3 or Sinpro Electronics Co Ltd, Model SPU31-106 or PSFD rated output 15Vdc, 2A. The equipment can also be used with any other power supply approved for Canada and USA under the 60950-1 or 61010-1 or equivalent standards and which provides Reinforced insulation between mains and secondary circuits. It must be rated for 3000m and up to 40°C and must provide an output of 15Vdc LPS with a minimum of 1A
- (2) Detachable cord set, to be delivered with the product, consisting of minimum NEMA 5-15 Plug, 3 x 18AWG cable and C13 Appliance coupler. For countries outside Canada and the USA the cable must be equivalent and must fulfill the national requirements for detachable cord sets.

18.3 FCC Supplier's Declaration of Conformity

FCC Supplier's Declaration of Conformity

Device type Electronical Precision, Milligram, Analytical, Semi Micro, Micro-Small and High-Capacity Balance

Type series **MCAvw-2x-y, MCEvw-2x-y**

v = 2.7, 3.6, 6.6, 10.6, 124, 125, 224, 225, 323, 324, 524, 623, 1202, 1203, 2202, 2203, 3203, 4202, 5201, 5202, 5203, 6202, 8201, 8202, 10202, 11201, 12201, 14202, 20201, 32202, 36200, 36201, 50201, 70200, 70201

w = S, P

x = S00, S01, CEU, CFR, CCN, OBR, OIN, ORU, OJP

y = A, E, F, I, M, O, R, U

**Party issuing Supplier's Declaration of Conformity /
Responsible Party – U.S. Contact Information**

Sartorius Corporation
5 Orville Dr Suite 200
11716 Bohemia, NY
USA
Telephone: +1.631.254.4249

FCC Compliance Statement

This device complies with Part 15 of the FCC Rules. Operation is subject to the following two conditions: (1) This device may not cause harmful interference, and (2) this device must accept any interference received, including interference that may cause undesired operation.

Information to the user

Note: This equipment has been tested and found to comply with the limits for a **class B** digital device, pursuant to part 15 of the FCC Rules. These limits are designed to provide reasonable protection against harmful interference in a residential installation. This equipment generates, uses and can radiate radio frequency energy and if not installed and used in accordance with the instructions, may cause harmful interference to radio communications. However, there is no guarantee that interference will not occur in a particular installation. If this equipment does cause harmful interference to radio or television reception, which can be determined by turning the equipment off and on, the user is encouraged to try to correct the interference by one or more of the following measures:

- Reorient or relocate the receiving antenna.
- Increase the separation between the equipment and receiver.
- Connect the equipment into an outlet on a circuit different from that to which the receiver is connected.
- Consult the dealer or an experienced radio/TV technician for help.

Connections between the device and peripherals must be made using shielded cables in order to maintain compliance with FCC radio frequency emission limits.

Any modifications made to this device that are not approved by Sartorius may void the authority granted to the user by the FCC to operate this equipment.

Doc: 2384181-00 SLL18FCC001-00.en 1 / 1 PMF: 2369813 OP-113_fo1_2015.10.12

Sartorius Lab Instruments GmbH & Co. KG
Otto-Brenner-Strasse 20
37079 Goettingen, Germany

Phone: +49.551.308.0
www.sartorius.com

The information and figures contained in these instructions correspond to the version date specified below.

Sartorius reserves the right to make changes to the technology, features, specifications and design of the equipment without notice.

Masculine or feminine forms are used to facilitate legibility in these instructions and always simultaneously denote the other gender as well.

Copyright notice:

This instruction manual, including all of its components, is protected by copyright.

Any use beyond the limits of the copyright law is not permitted without our approval.

This applies in particular to reprinting, translation and editing irrespective of the type of media used.

© Sartorius Germany

Last updated:
09 | 2019