



Biostat® B

The Multi-Talented
Bioreactor for Research
and Development

Simplifying Progress

SARTORIUS

Biostat® B at a Glance

Our Biostat® B is the ideal benchtop bioreactor for your lab. The multi-talented control tower opens up a new world of flexibility for your changing requirements. Use it as single or twin configuration, choose your cultivation chamber from our proven range of options (pictures below):

- Conventional stirred-tank Univessel® Glass
- Single-use stirred-tank Univessel® SU
- Wave-mixed RM Rocker with Flexsafe® RM bags



Univessel® Glass



Univessel® SU



RM Rocker

Proven Technology

With several thousand installations in over 50 countries, Biostat® B is the most successful benchtop bioreactor in the world. Benefit from our experience and collaboration with customers worldwide.

Configurable Design

Contact your Sartorius representative and configure your Biostat® B bioreactor solution matching your specific needs. Benefit from our flexible and scalable options.

Reliable Quality

Every Biostat® B is thoroughly tested before it leaves our production facilities in Germany. Benefit from our global service and application specialist network for professional installation and training.



Applications

- Process development, optimization and characterization
- Scale-up and scale-down studies
- Seed expansion and small scale production
- Cell bank production
- Protein supply
- Stem cell expansion and production (RM rocker)

Cells

- Mammalian
- Insect
- Microbial
- Yeast
- Fungi
- Plant

Industries

- Biopharmaceuticals
- Vaccines
- Cell therapies
- Industrial biotechnology
- Basic research
- Education

Process Modes

- Batch
- Fed-batch
- Continuous
- Perfusion

▶ Watch Video:
www.sartorius.com/video-biostat-b

Biostat® B – The Universal



Univessel® Glass

Our proven autoclavable borosilicate glass culture vessel is available in four different volumes: 1 L, 2 L, 5 L and 10 L for all kinds of cell culture and microbial applications.

Fully interchangeable glass and single-use stirred-tank culture vessels.

Univessel® SU

Our single-use 2 L stirred-tank vessel for cell culture applications combines scalable design with all the benefits of disposable solutions. No more worries about challenging timelines, workload or cross-contamination. Get started within minutes.



Benefits

- Classic stirred-tank design simplifies your scale-up and scale-down studies
- Extensive performance and engineering data package available
- Save additional investment and use our special design for small autoclaves

Benefits

- Fully single-use vessel, DO and pH sensors
- Proven, scalable stirred-tank design
- Connection kit to upgrade existing bioreactor controllers



Controller for Your Lab

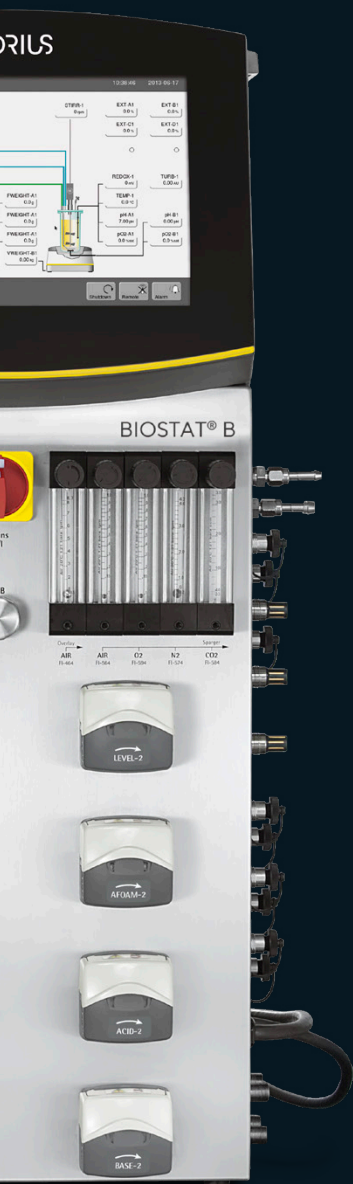

Benefits

- Easy-to-use rocker with advanced alarms and safety features for reliable cultivation
- Space-saving, individual control of two RM bags on the same rocker platform
- Inline viable biomass measurement for reduced sampling need and contamination risk



RM Rocker

Our proven wave-mixed bioreactor consists of a rocker unit with bag holder and pillow-shaped Flexsafe® RM single-use bags for culture volumes from 100 mL to 25 L. Use it as basic system or in combination with the Biostat® B control tower and single-use optical pH and DO sensors to enable advanced control strategies for batch, fed-batch and continuous perfusion.

New Flexsafe® Bag Family

Cell Growth

Excellent & reproducible growth behavior.

Assurance of Supply

Guaranteed consistent quality & continuous supply.

Robustness

Superior strength & flexibility of material.

One for All

No matter what size or process step.

Watch Video:

www.sartorius.com/sartorius/en/EUR/flexsafe

Biostat® B – Configurable Flexibility

Designed to meet your specific needs, Biostat® B covers a wide range of applications, extending from use as a flexible basic unit for preclinical research to a fully qualified system that complies with the requirements of a validated GMP environment.

12" Touch Screen

with closed frame; protected against water splashes and dust deposits. Easy-to-use and reliable operation of your Biostat® B due to intuitive design of human-machineinterface and advanced touch-screen technology – even while wearing laboratory gloves.

Control Tower

The control tower contains both the aeration, pump and temperature control modules, saving valuable bench space in your lab.

New Standards for Interference-Free Measurements

All inlets and ports for, e.g. cooling water, process gasses, electricity, ethernet and potential-free alarm contact are located on the rear panel of the control tower. An equipotential bonding conductor shields the bioreactor against electromagnetic current and ensures interference-free measurements during your processes.

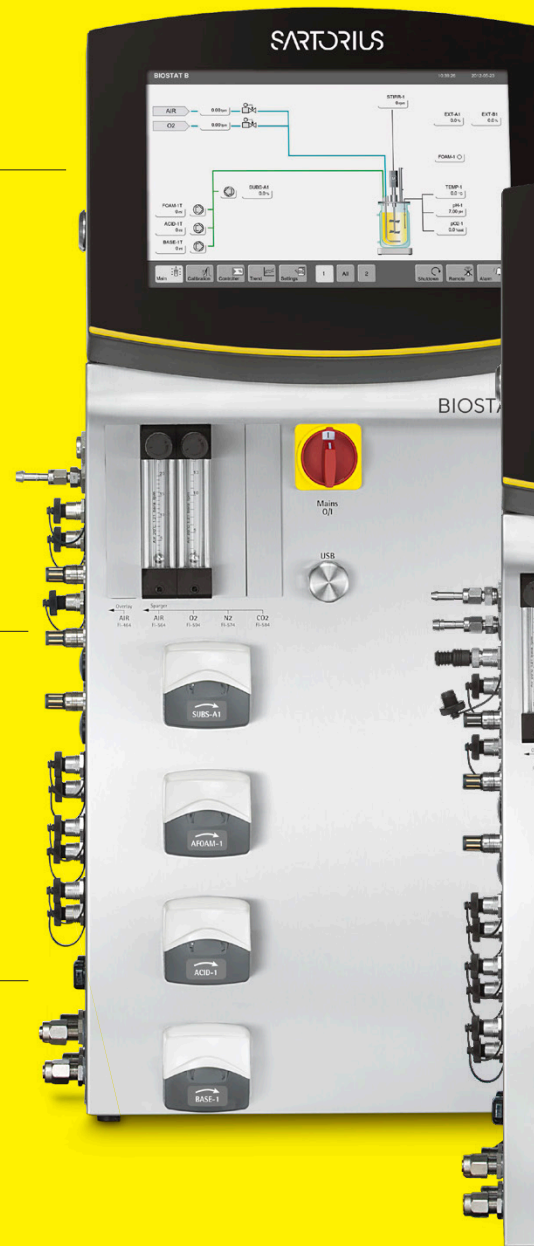

Single | Twin Control Tower

One Biostat® B control tower can control up to two vessels completely independently to save valuable lab space.

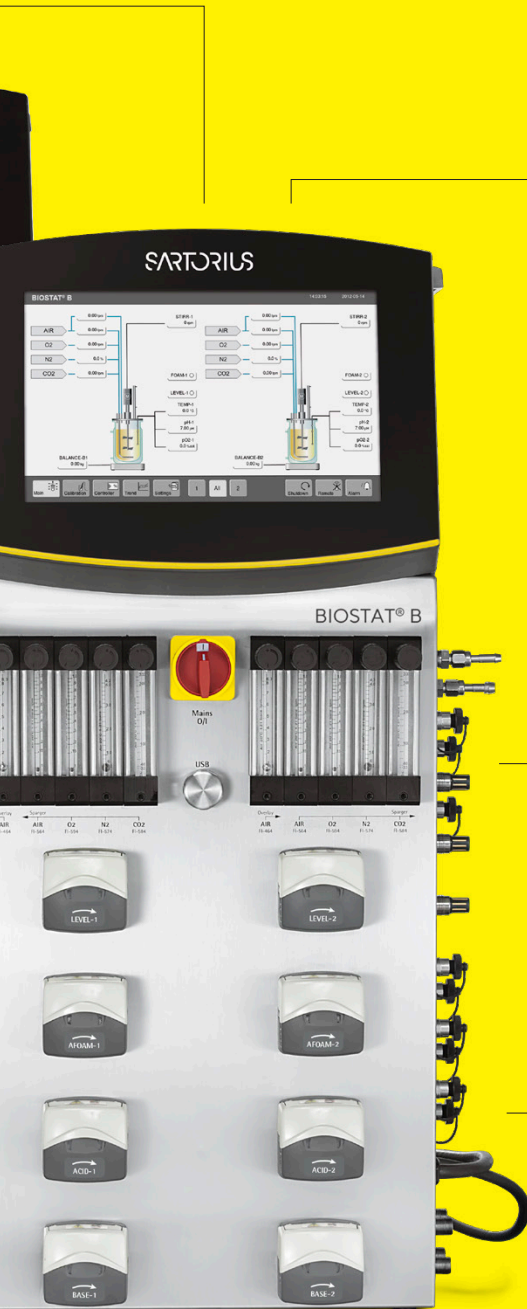

Storage Tray

A storage tray for accessories helps you organize your workplace.

Connections for Sensors and External Accessories

Quick-connect couplings make it easy to attach all cables and supplies to the culture vessels. All connections are clearly marked with the same names used on the rear control tower panel and in the local control software menu for fast, error proof identification.

Fast Load Peristaltic Pumps

Insert the tubing in seconds:
Open, insert tube, close, done! No more pinched fingers or torn gloves. Up to four internal pumps can be selected per vessel. Choose between speed-controlled pumps and fixed-speed pumps for feed and corrective agent addition.

Aeration Strategies

A series of flexible aeration options turns the Biostat® B into a multi-talented bioreactor for a wide range of different applications, including high-cell density microbial fermentation requiring considerable amounts of oxygen to high-cell density cell culture applications requiring removal of excess carbon dioxide.

Microbial Applications in Combination with Univessel® Glas

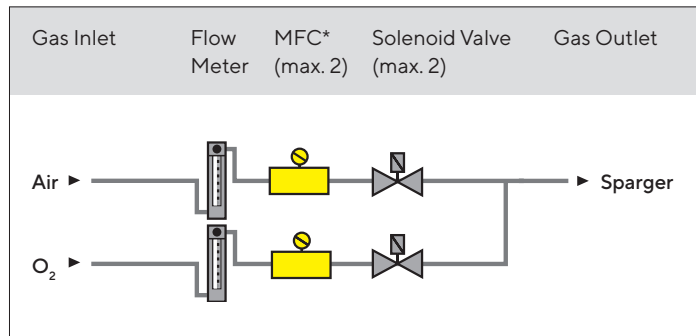

*MFC = mass flow controller

Various controller and hardware configurations enable aeration strategies using air or oxygen or classical O₂ enrichment of air. For anaerobic processes, the air inlet can be used for nitrogen. The standard built-in solenoid valves in combination with a flow meter ensure reliable gas supply for simple applications. Optional mass flow controllers provide exact flow rate control of individual gases.

In combination with BioPAT® Xgas off-gas analysis, this allows mass balancing of consumed and produced gases.

Cell Culture and Multi-Purpose Applications in Combination with Univessel® Glass and Univessel® SU

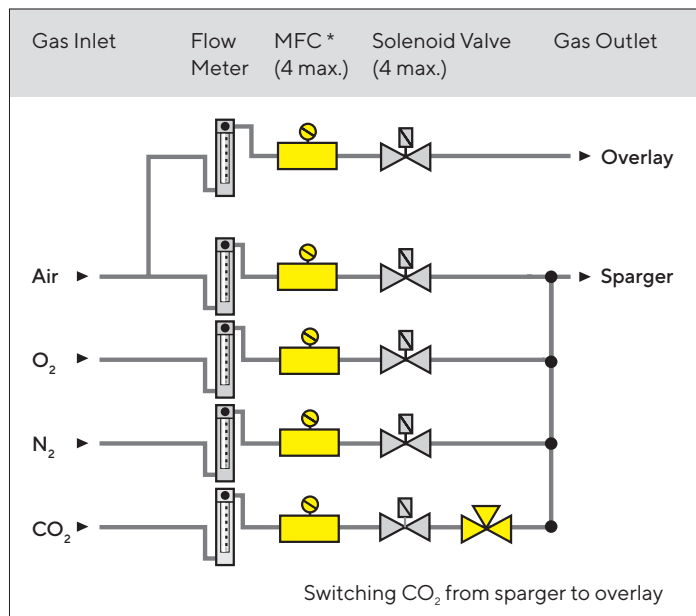

Five different gas lines (with flow meters) are equipped with solenoid valves and | or up to four optional mass flow controllers deliver ultimate flexibility and accuracy.

The Biostat® B allows you to optionally switch between sparger and overlay supply of CO₂ for pH control. In addition, a constant air | CO₂ mixture can be created in the overlay line to reproduce conditions set in a CO₂ incubator.

*MFC = mass flow controller

Cell Culture Applications in Combination with Our Rocking-Motion Bioreactor

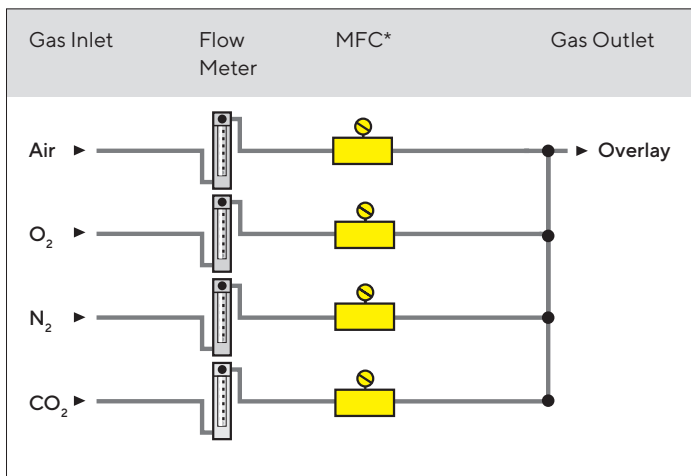

The wave generated in the RM bags due to the rocking motion ensures effective gas exchange through the gas-liquid interface. Four different gas lines for air, O₂, N₂ and CO₂ are equipped with flow meters and four high-precision mass flow controllers. An integrated pressure sensor continuously measures the pressure inside the bag. To ensure process safety, aeration is switched off when an upper threshold is reached.

*MFC = mass flow controller



You can configure your Biostat® B aeration system in a similar way to your Biostat STR® single-use stirred tank bioreactor. Get ready for seamless scale-up and -down, from laboratory scale to large scale single-use production.

BioPAT[®] DCU – Local Control

Since we introduced the first DCU-controlled bioreactors back in the late 80's, we have installed thousands of such bioreactors to date at leading companies in the pharmaceutical and biotech industry worldwide. We have continuously improved our robust, intuitive-use and industry-proven DCU control technology, now available in its fourth generation. It is our standard local control platform for our Biostat[®] bioreactors, Sartoflow[®] crossflow filtration units and Flexact[®] configurable systems available for a large number of unit operations.

The intuitive touch screen on the control tower is used to locally operate the Biostat[®] B:

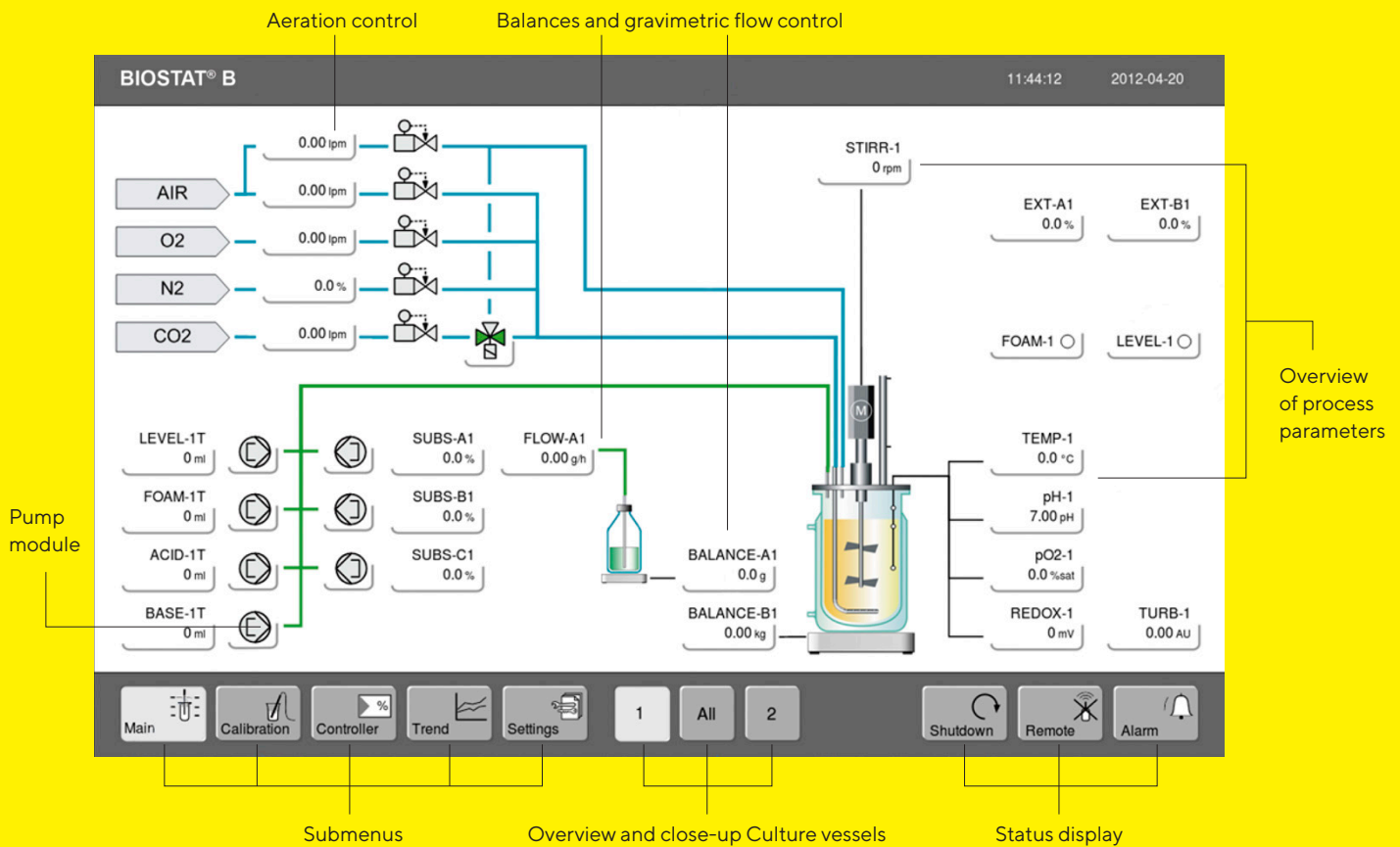

Automatic Feed Control and Continuous Processing

Design your process strategy or select different options. Configure your Biostat® B with gravimetric feed control, gravimetric level control or substrate addition profiles. This enables you to run your Biostat® B in batch, fed-batch, continuous or perfusion mode.

Automatic pH Control

Control the pH of your culture by automatic acid and base addition or by CO₂ aeration and base addition. If you want to use your Biostat® B for both microbial and cell culture you can configure your bioreactor system with the option of either CO₂ aeration or acid addition for pH (acid) control.

Automatic DO Control

Besides classic DO cascade control, we have developed the unique advanced DO controller that gives you more flexibility to develop and optimize your DO control strategy.

The advanced DO controller supports parallel adjustment of all DO affecting parameter settings like stirrer speed and gas flow rates of air and pure oxygen, automatically and

simultaneously to control the DO set point. Optionally, you can keep the total gas flow rate constant and the ratio of pure oxygen in the gas mixture is increased automatically to match the oxygen consumption of the culture.

This gives you ultimate flexibility to adapt your aeration strategy to your process requirements.

Constant Gas Flow

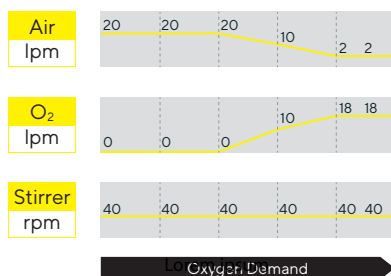

Constant gas flow decreases the flow of air and simultaneously increases oxygen flow keeping the total gas flow constant.

Constant Gas Ratio

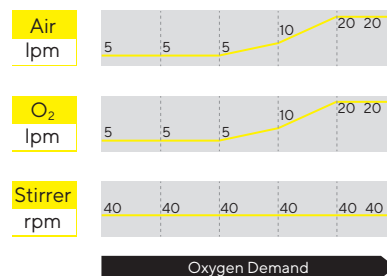

Constant gas ratio, increases both air and oxygen flows at the same rate keeping the ratio constant

Bubble Size Optimization

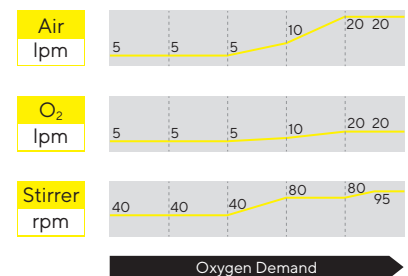

Bubble size optimization enables fine tuning of the oxygen percentage and gas-liquid interface area

BioPAT® MFCS – The Bioprocess SCADA System

BioPAT® MFCS is our SCADA software for supervisory bioprocess control and data acquisition to ensure process reliability, when used in combination with the advanced Biostat® B Control Tower for local process control. It is ideal for efficient data acquisition and trend monitoring.

The optional advanced version; BioPAT® MFCS win includes modules such as:

- Multi-user network access for up to 16 process units
- Automation with recipes according to ANSI | ISA 88.01
- 21 CFR, Part 11 compatibility



Learn more about the new BioPAT® MFCS:
www.sartorius.com/sartorius/en/EUR/biopat-mfcs

BioPAT[®] MODDE for Increased Process Understanding

BioPAT[®] MODDE is a state-of-the-art DoE software package which helps to understand complex processes and products.

The BioPAT[®] MFCS/win DoE module delivers a simple introduction into Design of Experiments, supported by a user-friendly design wizard providing step by step guidance for the experimental design and interpretation of results.

Automatic transfer of the experimental design parameters into an existing recipe allows for reliable and seamless integration into existing control strategies.

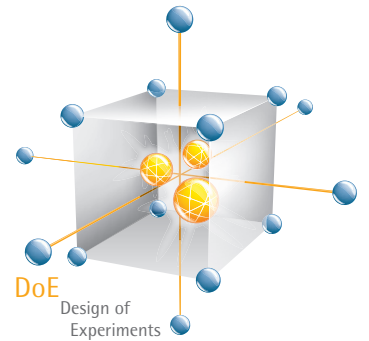

Maximized Process Security

To keep your biopharmaceutical process robust and reliable, we provide a comprehensive range of services to ensure the highest reliability and uptime of your Biostat® B, regulatory compliance and best quality of results.

From installation and qualification to regular preventative maintenance: Our service team will be happy to assist you on site and will be with you quickly thanks to our worldwide service network.



Installation & Commissioning

Safe and proper operation of your equipment right from the start



Qualification (IQ|QQ)

Compliance with GMP requirements, easy integration into your quality management system



Operator Training

Quality through greater experience: Sartorius trains the personnel operating your equipment

Installation Phase

Utilization Phase



Repairs & Spare Parts

In the event of service requests, we are quickly at your side with the necessary spare parts – worldwide



Maintenance & Contracts

Optimal equipment operation and protection against potential downtimes



Calibration

Accurate results in the long term and compliance with regulatory requirements



Service Contracts for the Entire System Lifecycle

With our Bioprocess Service Program, Sartorius offers service contracts to protect your equipment through its entire lifetime. Based on your specific risk assessment and requirements, you can choose between three Service Level Agreements: Essential, Advanced and Comprehensive. Protect your Biostat® B by choosing the appropriate service contract. For maximum productivity and minimum downtimes.

Essential

You benefit from:

- A plannable annual maintenance
- A fast support at the technical helpdesk within one business day and priority on-site-response
- In case of repair: A discount on all time and material based cost elements

Advanced

You benefit from:

- A plannable annual maintenance
- Technical helpdesk reaction time within 8 hours and 72 hours on-site response
- In case of repair: Labor and travel costs are covered, a discount of 10% on spare parts



















Comprehensive

You benefit from:

- A plannable annual maintenance
- Technical helpdesk reaction time within 4 hours and 48 hours on-site response
- In case of repair: All costs are covered

Your Benefits

- Process stability and minimized downtime
- Maximized system uptime, higher profitability
- Optimized total cost of ownership

	Essential	Advanced	Comprehensive
Reaction time			
Repair	 	 	 
	 	 	 
Maintenance			

 For further details and the dedicated datasheets, please have a look at our website: www.sartorius.com/service

Technical Specifications

Biostat® B

Control Tower Weight	
Single Twin	~ 40 55 kg (88 121 lbs.)
Control Tower Dimensions (W × H × D)	
Single Twin	350 × 822 × 430 mm (14" × 32" × 17")
Utility Connections	
Power supply	<ul style="list-style-type: none"> ▪ 230 V (± 10%), 50 Hz, max. power consumption 10 A ▪ 120 V (± 10%), 60 Hz, max. power consumption 12 A ▪ Potential equalisation
International protection rating	IP21
Gases	<ul style="list-style-type: none"> ▪ Gas supply pressure, 1.5 barg ▪ Dry, oil and dust-free ▪ Hose barb for tubing, external diameter = 6 mm
Water	<ul style="list-style-type: none"> ▪ Water supply pressure, 2–4 barg ▪ Flow rate up to 20 lpm ▪ Temperature min. = 4°C ▪ Discharge pressure-less ▪ Hose barb for tubing, external diameter = 10 mm ▪ Degree of hardness: max. 12° dH
Control Tower	
Housing	Stainless steel, AISI 304
Display	Touch screen, 12", glass, capacitive
Resolution	125 dpi
SCADA communication	Industrial Ethernet
Potential-free (common) alarm contact	▪
Safety valve gas pressure	1 bar (14.5 psi) for Univessel® Glass and SU 100 mbar for RM Rocker
Water inlet pressure reduction	1.5 bar (22 psi), integrated pressure control
Motor Drive (Univessel® Glass SU)	
Maintenance-free, quiet direct drive	Power: 200 W
Maintenance-free top drive with magnetic motor coupling	Power: 200 W
Rotation speed motor, direct coupling	1L: 20–2,000 rpm 2L: 20–2,000 rpm 5L: 20–1,500 rpm 10L: 20–800 rpm 2L SU: 20–400 rpm

RM Rocker 20 | 50

Power supply	<ul style="list-style-type: none"> ▪ 240 V (± 10%), 50 Hz, power consumption 10 A ▪ 100 V (± 10%), 60 Hz, power consumption 12 A
Power consumption	600 W
International protection rating	IP23
Rocking speed	8–42 ± 1 (r/min)
Rocking angle	4–10 ± 0.3 (°)
Load cells	100–240 V 15 W

Process Control | Sensors

	Sensor Measurement Range Display Accuracy	Univessel® Glass	Univessel® SU	RM Rocker 20 50
Temperature	Pt100 0–150°C (temperature control 0–80°C) 0.1°C	▪	▪	▪
Dissolved oxygen, reusable	Polarographic or optical 0–100% 0.1%	▪	▪	
Dissolved oxygen, single-use	0–100% 0.1%		▪	▪
pH, reusable	Combined measuring electrode 2–12 pH 0.01 pH	▪	▪	
pH, single-use	6.5–8.5 pH 0.1 pH		▪	▪
Foam control	Electrical conductive sensor, stainless steel, ceramic insulated	▪		
Level	Electrical conductive sensor, stainless steel, ceramic insulated	▪		
Turbidity	1-channel NIR absorption sensor 0–6 AU 0.01 AU	▪		
Redox	Combined measurement with pH sensor –1,000–1,000 mV 1 mV	▪	▪	
Balance substrate	7 kg max. 1 g 60 kg max. 10 g 300 kg max. 100 g	▪	▪	▪
Gravimetric Flow Controller	Accuracy for 7 kg balance: 5 g/h Accuracy for 60 kg balance: 50 g/h Accuracy for 300 kg balance: 500 g/h	▪	▪	▪
Balance culture vessel	60 kg max. 10 g	▪	▪	
RM load cells	30 kg max. 10 g Weight: 9 kg Dimensions: 609 536 60–68 mm			▪
External signal input	0–10 V or 4–20 mA Univessel® Glass SU: 4 max. RM Rocker: 2 max.	▪	▪	▪

Aeration Module

Outlet to culture vessel bag	Hose coupling Ø external = 6 mm
Univessel® Glass MO (Microbial)	Two-gas mixing with sparger outlet
Air with O ₂ Enrichment or Gas Flow Ratio mixing along with anaerobic fermentation; for further information, please see page on “Aeration Strategies”	
Max. total flow	Up to 20 L/min total volume flow
Flow meters	2
▪ Flow Range	Various models available: 0.1 – 20 liters per min. [lpm] (sparger)
▪ Accuracy	± 5% full scale
Mass flow controllers (optional)	2 max.
▪ Flow rate	Various models available: 0.03 – 20 lpm (sparger)
▪ Accuracy	± 1% full scale
Univessel® Glass CC (Cell Culture) Univessel® SU	Four-gas mixing with sparger and headspace outlet
Additive flow, 4-gas (Air, O ₂ , N ₂ , CO ₂) mixture; for further information, please see page on “Aeration Strategies”	
Max. total flow	Up to 13 L/min total volume flow
Flow meters	5
▪ Flow Range	Various models available: 3.3 ccm – 1.6 lpm (sparger) 0.16 lpm – 13 lpm (headspace)
▪ Accuracy	± 5% full scale
Mass flow controllers (optional)	4 max.
▪ Flow rate	Various models available: 1 ccm – 1.5 lpm (sparger) 0.03 lpm – 10 lpm (headspace)
▪ Accuracy	± 1% full scale
Univessel® Glass, Dual Use	Four-gas mixing with sparger and headspace outlet
Additive flow, 4-gas (Air, O ₂ , N ₂ , CO ₂) mixture; for further information, please see page on “Aeration Strategies”	
Max. total flow	Up to 20 L/min total volume flow
Flow meters	5
▪ Flow Range	Various models available: 3.3 ccm – 20 lpm (sparger) 50 ccm – 20 lpm (headspace)
▪ Accuracy	± 5% full scale
Mass flow controllers (optional)	4 max.
▪ Flow rate	Various models available: 0.6 ccm – 20 lpm (sparger) 10 ccm – 20 lpm (headspace)
▪ Accuracy	± 1% full scale

RM Rocker 20 50	Four-gas mixing with sparger and headspace outlet
Additive flow, 4-gas (Air, O ₂ , N ₂ , CO ₂) mixture; for further information, please see page on "Aeration Strategies"	
Flow meters	4
▪ Flow Range	Various models available: 16 ccm – 8.3 lpm (headspace)
▪ Accuracy	± 5% full scale
Mass flow controllers (optional)	4 max.
▪ Flow rate	Various models available: 3 ccm – 5 lpm (headspace)
▪ Accuracy	± 1% full scale

Pump Module

Built-in Pumps	
Fixed speed (on off controlled)	Watson Marlow 114, Fast Load pump head
▪ Speed 5 rpm Flow rate (tubing wall thickness 1.6 mm)	ID: 0.5 mm: 0 – 0.1 ml/min ID: 0.8 mm: 0 – 0.2 ml/min ID: 1.6 mm: 0.01 – 0.7 ml/min ID: 2.4 mm: 0.03 – 1.5 ml/min ID: 3.2 mm: 0.05 – 2.4 ml/min ID: 4.8 mm: 0.09 – 4.3 ml/min
▪ Speed 44 rpm Flow rate (tubing wall thickness 1.6 mm)	ID: 0.5 mm: 0.02 – 0.9 ml/min ID: 0.8 mm: 0.04 – 1.8 ml/min ID: 1.6 mm: 0.12 – 6.2 ml/min ID: 2.4 mm: 0.26 – 12.8 ml/min ID: 3.2 mm: 0.41 – 20.7 ml/min ID: 4.8 mm: 0.75 – 37.4 ml/min
Speed-controlled	Watson Marlow 114, Fast Load pump head
▪ Speed 0.15 – 5 rpm Flow rate (tubing wall thickness 1.6 mm)	ID: 0.5 mm: 0 – 0.1 ml/min ID: 0.8 mm: 0.01 – 0.2 ml/min ID: 1.6 mm: 0.02 – 0.7 ml/min ID: 2.4 mm: 0.04 – 1.5 ml/min ID: 3.2 mm: 0.07 – 2.4 ml/min ID: 4.8 mm: 0.13 – 4.3 ml/min
▪ Speed 5 – 150 rpm Flow rate (tubing wall thickness 1.6 mm)	ID: 0.5 mm: 0.1 – 3 ml/min ID: 0.8 mm: 0.2 – 6 ml/min ID: 1.6 mm: 0.7 – 21 ml/min ID: 2.4 mm: 1.45 – 43.5 ml/min ID: 3.2 mm: 2.35 – 70.5 ml/min ID: 4.8 mm: 4.25 – 127.5 ml/min
External Pumps	
Speed-controlled	Watson Marlow 120, Fast Load pump head, up to 200 rpm

Temperature Control Module

	Heating and Cooling	Heating Only
For Univessel® Glass Single-wall Culture Vessels	Electrical heating system and automatic cooling water valve; connection to heating blanket and cooling finger	-
	Temperature control of 8°C above cooling-water inlet temperature up to 60°C	-
	Heating blanket capacities 1 L 2 L 5 L 10 L: 100 170 400 780 W	-
For Univessel® Glass Double-wall (Jacketed) Culture Vessels	Open thermostat system with recirculation pump and automatic cooling water valve	-
	Temperature control of 8°C above cooling-water inlet temperature of up to 80°C	-
	Heating capacity: 600 W	-
For Univessel® SU Single-use Culture Vessels	Open thermostat system with recirculation pump and automatic cooling water valve; connection to heating cooling jacket	Electrical heating blanket
	Temperature control up to 50°C	Temperature control up to 50°C Heating capacity 2 L: 200 W
For RM Rocker 20 50	Open thermostat system with recirculation pump and automatic cooling water valve	Electrical heating plates
	Temperature control of 8°C above cooling-water inlet temperature of up to 40°C	Temperature control from room temperature up to 40°C
	Heating capacity: 600 W	Heating plates: 2 × 140 W

Culture Vessel Univessel® Glass

Autoclavable Single-wall or Double-wall (Jacketed) Glass Vessel	1 L	2 L	5 L	10 L
Material	Borosilicate glass, stainless steel AISI 316L, EPDM			
Sizes [L]	1	2	5	10
Total volume [L]	1.6	3	6.6	13
Working volume [L]	0.35–1	0.6–2	0.6–5	1.5 5–10
Top port 19 mm 12 mm 6 mm	3 2 6	3 2 9	3 3 8	5 2 9
Univessel® Glass, Single-wall	1 L	2 L	5 L	10 L
Weight ¹ [kg]	4.4	5.9	10.5	14.9
Space requirements in autoclave [diameter × height mm]	200 × 446	220 × 507	270 × 645	310 × 767
Space requirements in autoclave, reduced ² [diameter × height mm]	450 × 330	490 × 391	570 × 496	600 × 618
Univessel® Glass, Double-wall	1 L	2 L	5 L	10 L
Weight ¹ [kg]	5.3	6.9	12.6	18.5
Space requirements in autoclave [diameter × height mm]	320 × 446	335 × 507	395 × 645	435 × 767
Space requirements in autoclave, reduced ² [diameter × height mm]	450 × 330	490 × 391	570 × 496	600 × 618

¹ With tripod and head plate, without medium

² Adapter for exhaust cooler to reduce height in the autoclave optionally available

Culture Vessel Univessel® SU

Single-use vessel made of pre-sterilized polycarbonate for cell culture applications

Total volume [L]	2.6
Working volume [L]	0.6–2
Max. temperature	50°C
Operating pressure	< 0.5 barg

Basic Configurations for Univessel® Glass

The Biostat® B is a highly flexible and modular system that can be individually adapted to the requirements of your application. Below you will find an overview of the basic equipment which you can extend with diverse options.

Please contact your Sartorius Stedim Field Representative or Application Specialist for additional information.

Microbial Packages

Volume: 1 L, 2 L, 5 L or 10 L

Digital controller, color display with touch screen

Control temperature, pH, DO, stirrer speed

Maintenance-free, quiet motor

Storage tray for accessories

Aeration module with 2 solenoid valves

2 flow rate controllers for manual flow rate control
(Air | N₂, O₂)

Software configured for microbial applications

4-stage DO cascade

2 integrated pumps for pH control (acid | base)

Temperature control module for double-wall vessels

2 external signals 0–10 V

Standard test and documentation

Installation set for the gas and water connections

Power cable

Double-wall culture vessel

Stirrer shaft with single-mechanical seal and direct coupling

2 addition bottles for correction agents

Exhaust cooler

Aeration filters

Rushton impellers

Ring sparger

4-way addition port

Inoculation port

Harvest pipe, height-adjustable

Manual sampler

Tool set for disassembly of vessel

Pt100 temperature sensor

pH sensor

DO sensor, amperometric

Cell Culture Packages

Volume: 1 L, 2 L, 5 L or 10 L

Digital controller, color display with touch screen

Control temperature, pH, DO, stirrer speed

Maintenance-free, quiet motor

Storage tray for accessories

Aeration module with 4 solenoid valves

5 flow rate controllers for manual flow rate control
(Air Overlay, Air sparger, N₂, O₂, CO₂)

Software configured for cell culture applications

4-stage DO cascade

1 integrated pump for pH control (base)

Temperature control module for single-wall vessels

2 external signals 0–10 V

Standard test and documentation

Installation set for the gas and water connections

Power cable

Single-wall culture vessel

Heating blanket 120 | 230 V

Stirrer shaft with single mechanical seal and direct coupling

1 addition bottle for correction agent

Exhaust cooler

Aeration filters

3-blade segment impeller

Microsparger

4-way addition port

Harvest pipe, height-adjustable

Manual sampler

Tool set for vessel dismantling

Pt100 temperature sensor

pH sensor

DO sensor, amperometric

Options

Control System

Advanced DO controller

Flexible switching CO₂ from sparger to headspace

Software for dual use MO | CC

Mass flow controller

Antifoam control via sensor

Mechanical foam destroyer (MO applications)

Level control via sensor

Weight measurement substrates | culture vessel

Gravimetric feed | level control

Substrate addition via time profile

Redox (ORP) measurement

BioPAT® Fundalux turbidity measurement

BioPAT® Xgas O₂ | CO₂ off-gas analysis

System IQ | OQ

BioPAT® MFCS SCADA system

Univessel® Glass

Double-wall culture vessel

Magnetic coupling for drive motor

STT connectors for safe inoculation and media transfer

Cooling finger (single-wall culture vessels)

Spin filter for perfusion mode

Aeration basket for organisms sensitive to shear stress

Rushton impellers | 3-blade segment impellers

Baffles

Bottle holder

Adapter for height reduction of exhaust cooler for the autoclave

Inoculation port

3-way addition port

Universal adapter ID 3.2 mm

Harvest pipe bent for complete draining

Port adapter 19 mm - 12 mm

Set of consumables

Germany

Sartorius Stedim Biotech GmbH
August-Spindler-Strasse 11
37079 Goettingen
Phone +49 551 308 0

USA

Sartorius Stedim North America Inc.
565 Johnson Avenue
Bohemia, NY 11716
Toll-Free +1 800 368 7178

 For further contacts, visit
www.sartorius.com