



Univessel[®] Glass

Reliability and Continuity

Simplifying Progress

SARTORIUS

One For All

The Univessel® Glass is our platform cultivation vessel for all Biostat® benchtop bioreactors. It is available in 1 L, 2 L, 5 L and 10 L working volume. Benefit from the new design and the backward compatibility – all existing probes, dip tubes, spargers and impellers fit also into the new Univessel® Glass.

Get in contact with your local Sartorius representative and learn more about the new features – e.g. dishwasher proof stirrer shaft, ring sparger with bores facing downwards or the glass vessel fixation for cleaning.



Benefits

Reliability

Decades of experience made the Univessel® Glass the most reliable autoclavable cultivation vessel on the market.

Continuity

Compatible with all Biostat® benchtop bioreactors dating back to 2004. Dimensions and characteristics are untouched compared to the predecessor Univessel® Glass.

Ease of Use

Speed up cleaning with the dishwasher proof stirrer shaft and benefit from the new handling concept.

Configurability

More options for more flexibility in process development and characterization. The Univessel® Glass creates a greater design space for you.



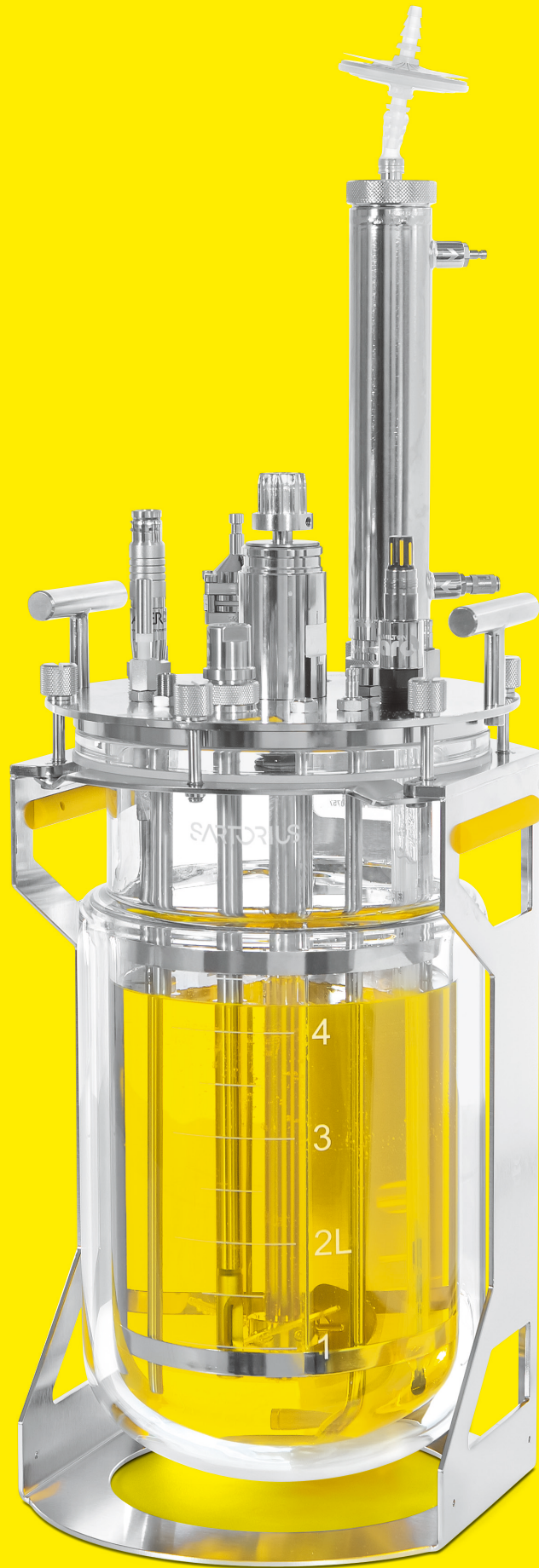

New Features

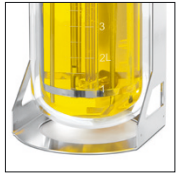

Stability

The round shaped bottom of the stand provides a maximum of sturdiness to the Univessel® Glass.



Ease of Cleaning

The complete dish-washer proof stirrer enables cleaning of the head plate in a dishwasher without removing the stirrer shaft.

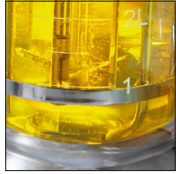

More Sparging Options

Now available: a ring sparger with holes facing downwards. Easy to clean and no dead volumes.



Ease of Handling

The additional, integrated handles make the Univessel® Glass more ergonomic and easier to carry – especially for 5 and 10 L vessels.



No More Damaged Glass Vessel

New fixation for cleaning to secure the glass vessel during the whole cleaning procedure. It only takes 5 seconds to protect your glass vessel.



Bottom Drain Outlet

The special bottom drain version makes it ideal for ATF and TFF based intensified processes.

Less Weight

Eliminating unnecessary weight, makes the Univessel® Glass lighter than ever without losing stability or risking sterility.

Documentation for Qualification

The documentation of our Univessel® Glass is designed to allow for full qualification as typically needed in a regulated environment. Request our comprehensive documentation package of manufacturer and material component certificates.

Technical Specifications

General

	Univessel® Glass 1 L single-wall (SW)	Univessel® Glass 1 L double-wall (DW)	Univessel® Glass 2 L single-wall (SW)	Univessel® Glass 2 L double-wall (DW)	Univessel® Glass 5 L single-wall (SW)	Univessel® Glass 5 L double-wall (DW)	Univessel® Glass 10 L single-wall (SW)	Univessel® Glass 10 L double-wall (DW)
Materials of major product wetted parts	Borosilicate glass, stainless steel AISI 316L, EPDM							
Weight without medium and accessories (stand, glass vessel, head plate, stirrer)	4.4 kg 9.4 lbs	5.3 kg 11.7 lbs	5.9 kg 13.0 lbs	6.9 kg 15.2 lbs	10.5 kg 23.1 lbs	12.6 kg 27.8 lbs	14.9 kg 32.8 lbs	18.5 kg 40.8 lbs
Top ports 19 mm 12 mm 6 mm	3 2 6	3 2 6	3 2 9 (3 3 8 for head plate with extra PG 13.5 port)	3 2 9 (3 3 8 for head plate with extra PG 13.5 port)	3 3 8	3 3 8	5 2 9	5 2 9

Outside Dimensions

Pos.	Unit	Univessel® Glass 1 L	Univessel® Glass 2 L	Univessel® Glass 5 L	Univessel® Glass 10 L
		Value	Value	Value	Value
D1	mm	110.0	130.0	160.0	190.0
H1	mm	224.0	285.0	390.0	512.0
H2	mm	446.0	507.0	645.0	767.0
H3	mm	558.0	619.0	757.0	879.0
H4	mm	158.0	220.0	315.0	421.0
H5	mm	278.0	340.0	435.0	541.0
H6	mm	330.0	391.0	496.0	618.0
H7	mm	14.0	14.0	14.0	14.0
B1	mm	156.0	176.0	231.0	281.0
B2	mm	239.0	262.0	314.5	364.5
D1	mm	172.0	198.0	228.0	270.0
T1	mm	196.0	216.5	266.0	306.0
T2	mm	319.0	332.0	392.0	433.0
T3	mm	234.5	234.5	285.0	285.0
T4	mm	353.0	342.0	409.8	433.4

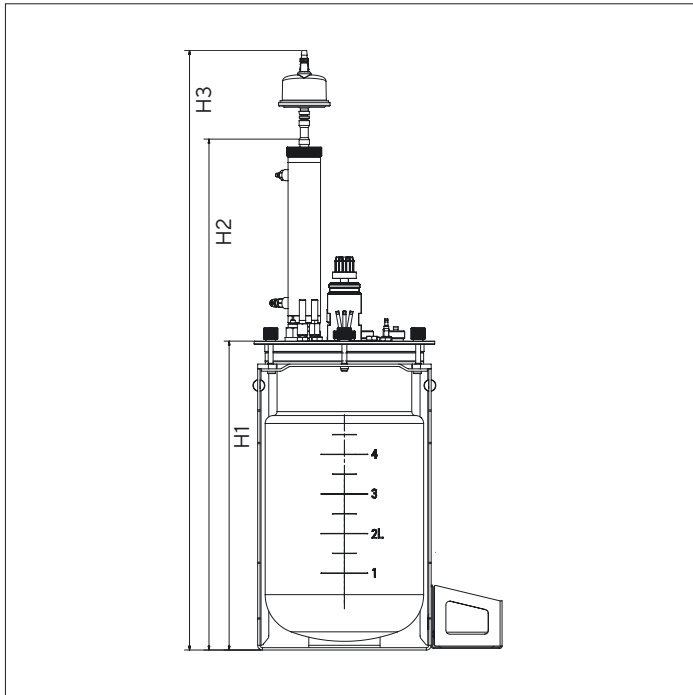

Univessel® Glass 5 L with exhaust cooler (example)

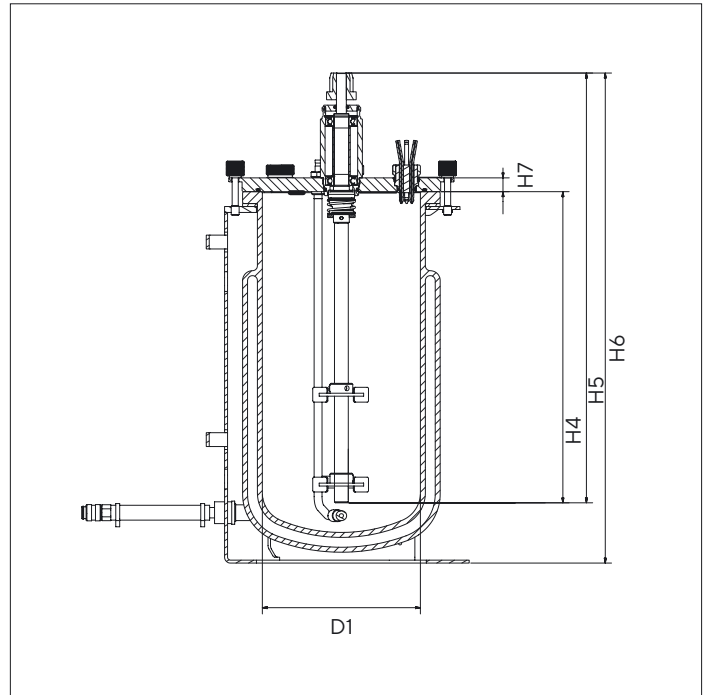

Univessel® Glass 5 L (DW) without exhaust cooler (example)

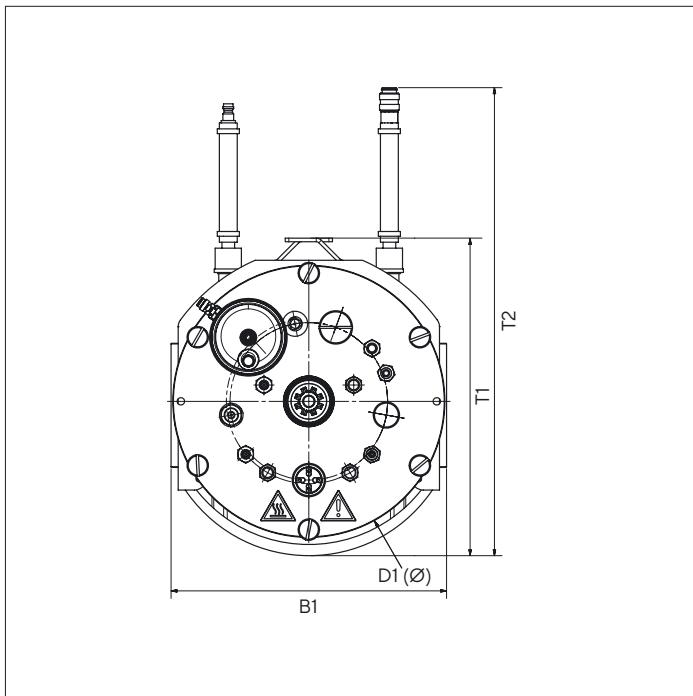

Univessel® Glass 5 L (DW) without bottle support (example)

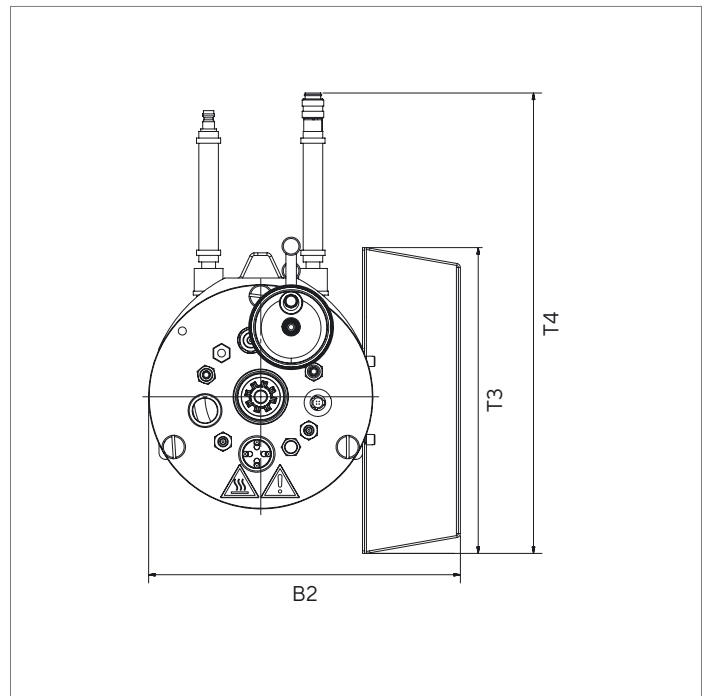

Univessel® Glass 1 L (DW) with bottle support (example)

Dimensions for Autoclaving

		Univessel® Glass 1 L (DW)	Univessel® Glass 1 L (SW)	Univessel® Glass 2 L (DW)	Univessel® Glass 2 L (SW)	Univessel® Glass 5 L (DW)	Univessel® Glass 5 L (SW)	Univessel® Glass 10 L (DW)	Univessel® Glass 10 L (SW)
Unit		Value	Value	Value	Value	Value	Value	Value	Value
Space requirement in the autoclave without flexible adapter for exhaust cooler									
Diameter	mm	320.0	200.0	335.0	220.0	395.0	270.0	435.0	310.0
Height	mm	446.0	446.0	507.0	507.0	645.0	645.0	767.0	767.0
Space requirement in the autoclave with flexible adapter for exhaust cooler									
Diameter	mm	450.0	450.0	490.0	490.0	570.0	570.0	600.0	600.0
Height	mm	330.0	330.0	391.0	391.0	496.0	496.0	618.0	618.0

Inside Dimensions

	Univessel® Glass 1 L	Univessel® Glass 2 L	Univessel® Glass 5 L	Univessel® Glass 10 L
Total volume [L]	1.6	3	7	13
Max. working volume [L]	1	2	5	10
Min. working volume [L]	0.35	0.4	0.6	1.5
Vessel diameter d_v [mm]	110	130	160	190
Vessel height h [mm]	180	240	345	470
Ratio $h d_v$	1.6	1.8	2.2	2.5
Liquid height h_L [mm]	110	180	280	360
Ratio $h_L d_v$	1	1.4	1.8	1.9
Diameter 6-blade disc impeller d_{i_1} [mm]	45	53	64	75
Diameter 3-blade segment impeller d_{i_2} [mm]	48	54	70	78
Ratio $d_{i_1} d_v$ (6-blade)	0.44	0.42	0.41	0.41
Ratio $d_{i_2} d_v$ (3-blade)	0.41	0.41	0.44	0.39



Flexible Adapter for Exhaust Cooler

Typically, the exhaust cooler and its fittings are at the highest point of the culture vessel. They have to be arranged vertically to enable condensate to flow back into the vessel. However, in the case of small autoclaves, the height of the fully equipped Univessel® Glass can be challenging.

Using a flexible adapter reduces height requirements in an autoclave. The adapter is installed between the exhaust cooler and its top plate port at the culture vessel.

Impeller Angle Tool

Helps to adjust easily the angle of the impeller blades to 30°.



Univessel® Glass 1L

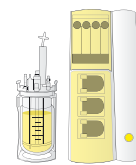

	Article number	Biostat® A (2014)	Biostat® Aplus
Univessel® Glass			
Univessel® Glass 1L, double wall (stand, reaction vessel, head plate)	UNIVESSEL-00001		
Univessel® Glass 1L, single wall (stand, reaction vessel, head plate)	UNIVESSEL-00005	<input type="checkbox"/>	<input type="checkbox"/>
Reaction vessel double wall	SB-18-14-0001		
Reaction vessel single wall	SB-18-14-0005	<input type="checkbox"/>	<input type="checkbox"/>
Head plate	SB-18-14-0009	<input type="checkbox"/>	<input type="checkbox"/>
Stand (incl. support bracket)	SB-18-14-0013	<input type="checkbox"/>	<input type="checkbox"/>
Silicone support ring Ø 140 mm	SB-18-14-0017	<input type="checkbox"/>	<input type="checkbox"/>
O-Ring for head plate	SB-80-01-0037	<input type="checkbox"/>	<input type="checkbox"/>
Stirrer shaft			
Stirrer shaft, single mechanical seal	SB-18-14-0022	<input type="checkbox"/>	<input type="checkbox"/>
Standard direct coupling	SB-18-14-0026	<input type="checkbox"/>	
Biostat® Aplus direct coupling	BB-39240983		<input type="checkbox"/>
Biostat® Qplus direct coupling	BB-8841221		
Standard magnetic coupling	SB-18-14-0031		
Mixing			
6-blade disc impeller	BB-8846359	<input type="checkbox"/>	<input type="checkbox"/>
3-blade segment impeller	BB-8846367	<input type="checkbox"/>	<input type="checkbox"/>
Baffle cage	BB-8846375	<input type="checkbox"/>	<input type="checkbox"/>
Aeration			
Ring sparger (bores downwards)	UNIVESSEL-00011	<input type="checkbox"/>	<input type="checkbox"/>
Ring sparger (bores upwards)	BB-8846383	<input type="checkbox"/>	<input type="checkbox"/>
Micro sparger	UNIVESSEL-00055	<input type="checkbox"/>	<input type="checkbox"/>
Aeration basket	BB-8846405	<input type="checkbox"/>	<input type="checkbox"/>
Biostat® B, B-DCU II, B-DCU (2016) exhaust cooler	UNIVESSEL-00025		
Biostat® Aplus, Bplus, Qplus exhaust cooler	BB-8846871		<input type="checkbox"/>
Biostat® A exhaust cooler	BB-8822009	<input type="checkbox"/>	
Flexible adapter for exhaust cooler	BB-8844593	<input type="checkbox"/>	<input type="checkbox"/>
Biostat® A exhaust for filter heater	BB-34164267	<input type="checkbox"/>	
Biostat® A filter heater for Univessel® Glass SU	BB-8822023	<input type="checkbox"/>	
Air inlet exhaust filter, Midisart® 2000 (12 pc)	17805-----E	<input type="checkbox"/>	<input type="checkbox"/>
Air inlet exhaust filter Sartofluor® Capsule	5181307T5--OO--D	<input type="checkbox"/>	<input type="checkbox"/>
Filterkit (1 × Midisart® 2000 8" MNPT, 3 × Midisart® 2000 Hose Barb, 5 × Minisart® SRP15)	UNIVESSEL-KIT1	<input type="checkbox"/>	<input type="checkbox"/>

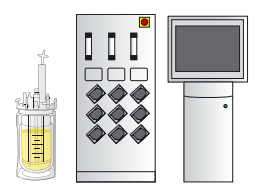
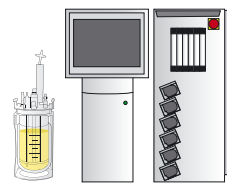
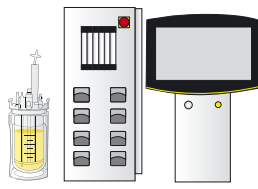
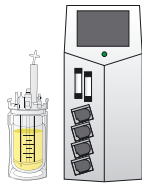
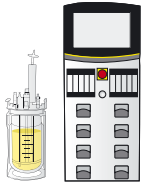

Biostat® B

Biostat® Bplus

Biostat® B-DCU
(2016)

Biostat® B-DCU II

Biostat® Qplus

Univessel® Glass 1L

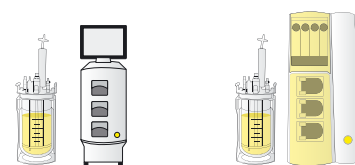

	Article number	Biostat® A (2014)	Biostat® Aplus
Dip tubes			
Dip tube; straight, height-adjustable, ID 4 mm	BB-8848637	<input type="checkbox"/>	<input type="checkbox"/>
Dip tube; straight, fixed, ID 4 mm	BB-8848629	<input type="checkbox"/>	<input type="checkbox"/>
Dip tube; straight, height-adjustable, ID 2 mm	UNIVESSEL-00015	<input type="checkbox"/>	<input type="checkbox"/>
Dip tube; bended, height-adjustable, ID 4 mm	BB-8848633	<input type="checkbox"/>	<input type="checkbox"/>
Dip tube; for ATF connection, straight, height-adjustable, ID 10 mm	UNIVESSEL-00036	<input type="checkbox"/>	<input type="checkbox"/>
Cooling fingers and tubing set for chiller			
Standard cooling finger	UNIVESSEL-00021		
Biostat® Aplus, Qplus cooling finger	BB-8846456		<input type="checkbox"/>
Biostat® A cooling finger	BB-8822024	<input type="checkbox"/>	
Tube connection set Biostat® A chiller	BB-8822027	<input type="checkbox"/>	
Foam disc			
Foam disc 74 10	BB-8844465	<input type="checkbox"/>	<input type="checkbox"/>
pH sensors			
Standard pH sensor, Hamilton EasyFerm Plus, 160 mm	BB-8848655		
Digital pH sensor, Hamilton EasyFerm Bio Arc, 160 mm	UZE---0001		
Standard pH sensor, Mettler, 150 mm	BB-8848691		
Biostat® A sensor package (pH and DO) E+H 160 mm	BB-8822010	<input type="checkbox"/>	
Biostat® Aplus pH sensor, Hamilton, 160 mm	BB-34090811		<input type="checkbox"/>
Biostat® Aplus pH sensor, Mettler, 150 mm	BB-34099264		<input type="checkbox"/>
Biostat® Bplus pH sensor, Hamilton, 160 mm	BB-8837241		
Biostat® Qplus pH sensor, Hamilton, 160 mm	BB-8837239		
pH & Redox sensor, Hamilton EasyFerm Plus, 160 mm	BB-8844201		
pH & Redox sensor, Mettler, 150 mm	BB-8844211		
DO sensors			
Standard DO sensor, optical, Hamilton VisiFerm DO, 160 mm (Arc and analog)	BB-8848669		
Standard DO sensor, electrochemical, Hamilton OxyFerm DO, 160 mm	BB-8848662		
Standard DO sensor, electrochemical, Mettler, 150 mm	BB-8848675		
Biostat® A sensor package (pH and DO) E+H 160 mm	BB-8822010	<input type="checkbox"/>	
Biostat® Aplus DO sensor, electrochemical, Hamilton, 160 mm	BB-34090821		<input type="checkbox"/>
Biostat® Bplus DO sensor, electrochemical, Hamilton, 160 mm	BB-8837231		
Biostat® Qplus DO sensor, electrochemical, Hamilton, 160 mm	BB-8837235		

Univessel® Glass 1L

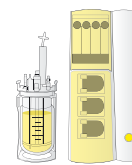

	Article number	Biostat® A (2014)	Biostat® Aplus
Turbidity sensors (connected to tower of bioreactor)			
BioPAT® Fundalux, Ø 12 mm, optical path length 1 mm	BPF1L01		
BioPAT® Fundalux, Ø 12 mm, optical path length 5 mm	BPF1L05		
BioPAT® Fundalux, Ø 12 mm, optical path length 10 mm	BPF1L10		
Trace probes (connected to BioPAT® Trace)			
BioPAT® Trace dialysis probe, 165 mm	BPT0015	<input type="checkbox"/>	<input type="checkbox"/>
BioPAT® Trace membranes for dialysis probes (Glc Lac) standard, 5 pc.	BPT0024	<input type="checkbox"/>	<input type="checkbox"/>
BioPAT® Trace membranes for dialysis probes (Glc Lac) cellulase stable; 5 pc.	BPT0040	<input type="checkbox"/>	<input type="checkbox"/>
BioPAT® Trace membranes for dialysis probe (EtOH MeOH), 5 pc.	BPT0047	<input type="checkbox"/>	<input type="checkbox"/>
Biomass sensors			
BioPAT® Viamass multiuse ABER sensor, 128 mm	BPVOM1L		
Temperature sensor			
Standard Pt100 with thermowell (pocket), 151 mm	BB-8848648		
Biostat® Aplus Pt100, 151 mm	BB-33197105		<input type="checkbox"/>
Biostat® Bplus, Qplus Pt100, 151 mm	BB-33197024		
Level and foam sensors			
Standard level sensor, 150 mm, clip (6 mm port)	BB-8844490	<input type="checkbox"/>	
Biostat® Aplus, Bplus, Qplus level sensor, 150 mm, incl. cable (6 mm port)	BB-8844488		<input type="checkbox"/>
Standard foam sensor, 80 mm, clip (6 mm port)	BB-8844463		
Pressure sensor 0.0 - 1.0 barg, autoclavable (M26x1)	BB-8804060		
Sensor cables			
DO sensor connection cable, VP8-VP8, 1m	BB-8848685		
pH sensor connection cable, VP8-VP8, 1m	BB-8848681		
pH DO Arc sensor cable, M12-VP8, 1m	UZE---0005		
Level foam sensor connection cable, clip-M12, 1m	BB-8848684	<input type="checkbox"/>	
Level foam sensor connection cable, clip-clip, 1m	SB-38125129		<input type="checkbox"/>
Foam sensor connection cable, clip-M12, 1m	BB-8848683		
Pressure sensor connection cable, M12-M12, 2m	BB-34147287		

Univessel® Glass 1 L

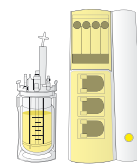

	Article number	Biostat® A (2014)	Biostat® Aplus
Heating blankets			
Standard heating blanket 120 230V	BB-8842191		
Biostat® A Heating blanket, 48VDC	BB-8822028	<input type="checkbox"/>	
Biostat® Aplus, Bplus heating blanket, 120 VAC	BB-8807501		<input type="checkbox"/>
Biostat® Aplus, Bplus heating blanket, 230 VAC	BB-8807502		<input type="checkbox"/>
Handling			
Reaction vessel fixation for cleaning	UNIVESSEL-00049	<input type="checkbox"/>	<input type="checkbox"/>
Tool and accessory kit	UNIVESSEL-00045	<input type="checkbox"/>	<input type="checkbox"/>
Bottle support for 250 mL bottles	UNIVESSEL-00019	<input type="checkbox"/>	<input type="checkbox"/>
Integrated handle bar	UNIVESSEL-00033	<input type="checkbox"/>	<input type="checkbox"/>
Handle for installation on the head plate	UNIVESSEL-00044	<input type="checkbox"/>	<input type="checkbox"/>
Impeller angle tool	UNIVESSEL-00059	<input type="checkbox"/>	<input type="checkbox"/>

Univessel® Glass 2 L

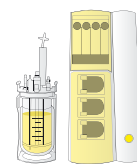

	Article number	Biostat® A (2014)	Biostat® Aplus
Univessel® Glass			
Univessel® Glass 2 L, double wall (stand, reaction vessel, head plate)	UNIVESSEL-00002		
Univessel® Glass 2 L, single wall (stand, reaction vessel, head plate)	UNIVESSEL-00006	<input type="checkbox"/>	<input type="checkbox"/>
Reaction vessel double wall	SB-18-14-0002		
Reaction vessel single wall	SB-18-14-0006	<input type="checkbox"/>	<input type="checkbox"/>
Univessel® Glass 2 L, single wall with extra PG13.5 port, w/o accessories	UNIVESSEL-00065		
Univessel® Glass 2 L, double wall with extra PG13.5 port, w/o accessories	UNIVESSEL-00066		
Kit Univessel® Glass w/ bottom drain 2 L single wall	UNIVESSEL-00077		
Kit Univessel® Glass w/ bottom drain 2 L double wall	UNIVESSEL-00080		
Head plate	SB-18-14-0010	<input type="checkbox"/>	<input type="checkbox"/>
Stand (incl. support bracket)	SB-18-14-0014	<input type="checkbox"/>	<input type="checkbox"/>
Silicone support ring Ø 160 mm	SB-18-14-0018	<input type="checkbox"/>	<input type="checkbox"/>
O-Ring for head plate	SB-80-01-0035	<input type="checkbox"/>	<input type="checkbox"/>
Stirrer shaft			
Stirrer shaft, single mechanical seal	SB-18-14-0023	<input type="checkbox"/>	<input type="checkbox"/>
Standard direct coupling	SB-18-14-0026	<input type="checkbox"/>	
Biostat® Aplus direct coupling	BB-39240983		<input type="checkbox"/>
Standard magnetic coupling	SB-18-14-0031		

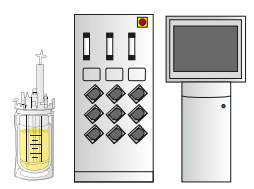
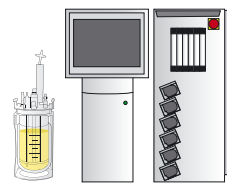
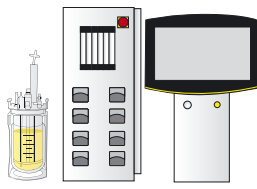
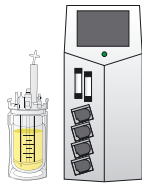
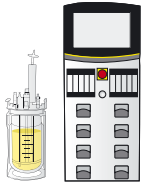

Biostat® B

Biostat® Bplus

Biostat® B-DCU
(2016)

Biostat® B-DCU II

Biostat® Qplus

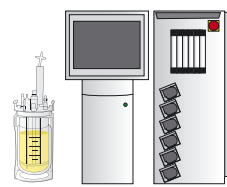
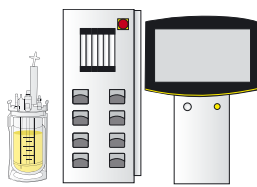
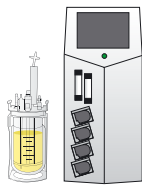
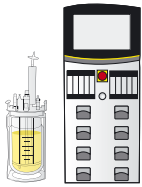

Biostat® B

Biostat® Bplus

Biostat® B-DCU
(2016)

Biostat® B-DCU II

Univessel® Glass 2 L

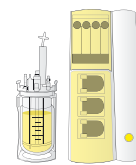

	Article number	Biostat® A (2014)	Biostat® Aplus
Mixing			
6-blade disc impeller	BB-8846804	<input type="checkbox"/>	<input type="checkbox"/>
3-blade segment impeller	BB-8847398	<input type="checkbox"/>	<input type="checkbox"/>
Baffle cage	BB-8846812	<input type="checkbox"/>	<input type="checkbox"/>
Aeration			
Ring sparger (bores downwards)	UNIVESSEL-00012	<input type="checkbox"/>	<input type="checkbox"/>
Ring sparger (bores upwards)	BB-8846847	<input type="checkbox"/>	<input type="checkbox"/>
Micro sparger	UNIVESSEL-00056	<input type="checkbox"/>	<input type="checkbox"/>
Aeration basket	BB-8848009	<input type="checkbox"/>	<input type="checkbox"/>
Biostat® B, B-DCU II, B-DCU (2016) exhaust cooler	UNIVESSEL-00025		
Biostat® Aplus, Bplus, Qplus exhaust cooler	BB-8846871		<input type="checkbox"/>
Biostat® A exhaust cooler	BB-8822009	<input type="checkbox"/>	
Flexible adapter for exhaust cooler	BB-8844593	<input type="checkbox"/>	<input type="checkbox"/>
Biostat® A exhaust line for filter heater	BB-34164267	<input type="checkbox"/>	
Biostat® A filter heater for Univessel® Glass SU	BB-8822023	<input type="checkbox"/>	
Air inlet exhaust filter, Midisart® 2000 (12 pc)	17805-----E	<input type="checkbox"/>	<input type="checkbox"/>
Air inlet exhaust filter, Sartofluor® Capsule	5181307T5--OO--D	<input type="checkbox"/>	<input type="checkbox"/>
Filterkit (1 × Midisart® 2000 8" MNPT, 3 × Midisart® 2000 Hose Barb, 5 × Minisart® SRP15)	UNIVESSEL-KIT1	<input type="checkbox"/>	<input type="checkbox"/>
Spinfilter			
Spinfilter 10 µm	BB-8847447	<input type="checkbox"/>	<input type="checkbox"/>
Spinfilter 20 µm	BB-8808309	<input type="checkbox"/>	<input type="checkbox"/>
Spinfilter 75 µm	BB-8808325	<input type="checkbox"/>	<input type="checkbox"/>
Draft tube	BB-8840539	<input type="checkbox"/>	<input type="checkbox"/>
Dip tubes			
Dip tube; straight, height-adjustable, ID 4 mm	BB-8807884	<input type="checkbox"/>	<input type="checkbox"/>
Dip tube; straight, fixed, ID 4 mm	BB-8807850	<input type="checkbox"/>	<input type="checkbox"/>
Dip tube; straight, for spinfilter, ID 4 mm	BB-8808260	<input type="checkbox"/>	<input type="checkbox"/>
Dip tube; straight, height-adjustable, ID 2 mm	UNIVESSEL-00016	<input type="checkbox"/>	<input type="checkbox"/>
Dip tube; bended, height-adjustable, ID 4 mm	BB-8848634	<input type="checkbox"/>	<input type="checkbox"/>
Dip tube; for ATF connection, straight, height-adjustable, ID 10 mm	UNIVESSEL-00037	<input type="checkbox"/>	<input type="checkbox"/>
Cooling fingers and tubing set for chiller			
Standard cooling finger	UNIVESSEL-00022		
Biostat® Aplus cooling finger	BB-8847819		<input type="checkbox"/>
Biostat® A cooling finger	BB-8822025	<input type="checkbox"/>	
Tube connection set Biostat® A chiller	BB-8822027	<input type="checkbox"/>	

Univessel® Glass 2 L

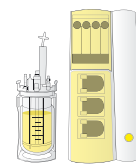

	Article number	Biostat® A (2014)	Biostat® Aplus
Foam disc			
Foam disc 84/10	BB-8844466	<input type="checkbox"/>	<input type="checkbox"/>
pH sensors			
Standard pH sensor, Hamilton EasyFerm Plus, 225 mm	BB-8848656		
Standard pH sensor, Mettler, 220 mm	BB-8848692		
Digital pH sensor, Hamilton EasyFerm Bio Arc, 225 mm	UZE---0002		
Biostat® A sensor package (pH and DO) E+H, 225 mm	BB-8822011	<input type="checkbox"/>	
Biostat® Aplus pH sensor, Hamilton, 200 mm	BB-34090812		<input type="checkbox"/>
Biostat® Aplus pH sensor, Mettler, 200 mm	BB-33182582		<input type="checkbox"/>
Biostat® Bplus pH sensor, Hamilton, 200 mm	BB-8837242		
pH & Redox sensor, Hamilton EasyFerm Plus, 225 mm	BB-8844202		
pH & Redox sensor, Mettler, 220 mm	BB-8844212		
DO sensors			
Standard DO sensor, optical, Hamilton VisiFerm DO, 225 mm (Arc and analog)	BB-8848670		
Standard DO sensor, electrochemical, Hamilton OxyFerm DO, 225 mm	BB-8848663		
Standard DO sensor, electrochemical, Mettler, 220 mm	BB-8848676		
Biostat® A sensor package (pH and DO) E+H, 225 mm	BB-8822011	<input type="checkbox"/>	
Biostat® Aplus DO sensor, electrochemical, Hamilton, 215 mm	BB-34090822		<input type="checkbox"/>
Biostat® Bplus DO sensor, electrochemical, Hamilton, 215 mm	BB-8837232		
Turbidity sensors (connected to tower of bioreactor)			
BioPAT® Fundalux, Ø 12 mm, optical path length 1 mm	BPF2L01		
BioPAT® Fundalux, Ø 12 mm, optical path length 5 mm	BPF2L05		
BioPAT® Fundalux, Ø 12 mm, optical path length 10 mm	BPF2L10		
Trace probes (connected to BioPAT® Trace)			
BioPAT® Trace dialysis probe, 212 mm	BPT0016	<input type="checkbox"/>	<input type="checkbox"/>
BioPAT® Trace membranes for dialysis probes (Glc Lac) Standard, 5 pc.	BPT0024	<input type="checkbox"/>	<input type="checkbox"/>
BioPAT® Trace membranes for dialysis probes (Glc Lac) cellulase stable; 5 pc.	BPT0040	<input type="checkbox"/>	<input type="checkbox"/>
BioPAT® Trace membranes for dialysis probe (Eth Met), 5 pc.	BPT0047	<input type="checkbox"/>	<input type="checkbox"/>
Biomass sensors			
BioPAT® Viamass multiuse ABER sensor, 228 mm	BPV0M2L		

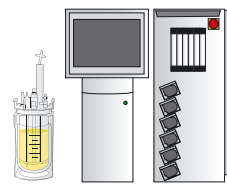
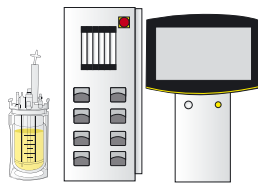
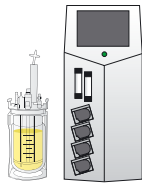
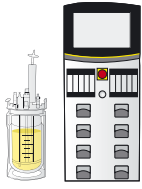

Biostat® B

Biostat® Bplus

Biostat® B-DCU
(2016)

Biostat® B-DCU II

Univessel® Glass 2 L

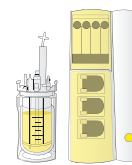

	Article number	Biostat® A (2014)	Biostat® Aplus
Temperature sensor			
Standard Pt100 with thermowell (pocket), 211 mm	BB-8848649		
Biostat® Aplus Pt100, 211 mm	BB-33197083		<input type="checkbox"/>
Biostat® Bplus Pt100, 211 mm	BB-33197032		
Level and foam sensors			
Standard level sensor, 150 mm, clip (6 mm port)	BB-8844490	<input type="checkbox"/>	
Standard foam sensor, 80 mm, clip (6 mm port)	BB-8844463		
Biostat® Aplus, Bplus foam sensor, 80 mm, incl. cable (6 mm port)	BB-8844461		<input type="checkbox"/>
Pressure sensor 0.0–1.0 barg, autoclavable (M26×1)	BB-8804060		
Sensor cables			
DO sensor connection cable, VP8-VP8, 1 m	BB-8848685		
pH sensor connection cable, VP8-VP8, 1 m	BB-8848681		
pH DO Arc sensor cable, M12-VP8, 1 m	UZE---0005		
Level foam sensor connection cable, clip-M12, 1 m	BB-8848684	<input type="checkbox"/>	
Level foam sensor connection cable, clip-clip, 1 m	SB-38125129		<input type="checkbox"/>
Foam sensor connection cable, clip-M12, 1 m	BB-8848683		
Pressure sensor connection cable, M12-M12, 2 m	BB-34147287		
Heating blankets			
Standard heating blanket 120 230V	UNIVESSEL-00075		
Biostat® A heating blanket, 48 VDC	UNIVESSEL-00074	<input type="checkbox"/>	
Biostat® Aplus, Bplus heating blanket, 120 VAC	BB-8807541		<input type="checkbox"/>
Biostat® Aplus, Bplus heating blanket, 230 VAC	BB-8807542		<input type="checkbox"/>
Handling			
Reaction vessel fixation for cleaning	UNIVESSEL-00050	<input type="checkbox"/>	<input type="checkbox"/>
Tool and accessory kit	UNIVESSEL-00046	<input type="checkbox"/>	<input type="checkbox"/>
Bottle support for 250 mL bottles	UNIVESSEL-00019	<input type="checkbox"/>	<input type="checkbox"/>
Integrated handle bar	UNIVESSEL-00033	<input type="checkbox"/>	<input type="checkbox"/>
Handle for installation on the head plate	UNIVESSEL-00044	<input type="checkbox"/>	<input type="checkbox"/>
Impeller angle tool	UNIVESSEL-00060	<input type="checkbox"/>	<input type="checkbox"/>

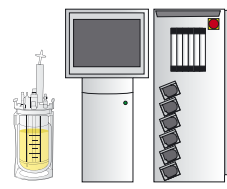
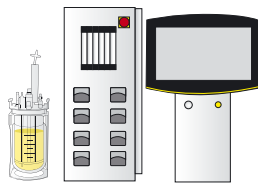
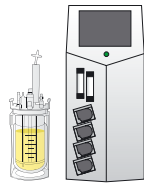
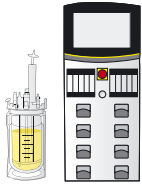

Biostat® B

Biostat® Bplus

Biostat® B-DCU
(2016)

Biostat® B-DCU II

Univessel® Glass 5 L

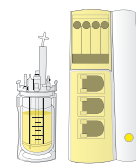

	Article number	Biostat® A (2014)	Biostat® Aplus
Univessel® Glass			
Univessel® Glass 5 L, double wall (stand, reaction vessel, head plate)	UNIVESSEL-00003		
Univessel® Glass 5 L, single wall (stand, reaction vessel, head plate)	UNIVESSEL-00007	<input type="checkbox"/>	<input type="checkbox"/>
Reaction vessel double wall	SB-18-14-0003		
Reaction vessel single wall	SB-18-14-0007	<input type="checkbox"/>	<input type="checkbox"/>
Kit Univessel® Glass w/ bottom drain 5 L single wall	UNIVESSEL-00078		
Kit Univessel® Glass w/ bottom drain 5 L double wall	UNIVESSEL-00081		
Head plate	SB-18-14-0011	<input type="checkbox"/>	<input type="checkbox"/>
Stand (incl. support bracket)	SB-18-14-0015	<input type="checkbox"/>	<input type="checkbox"/>
Silicone support ring Ø 200 mm	SB-18-14-0019	<input type="checkbox"/>	<input type="checkbox"/>
O-Ring for head plate	SB-80-01-0032	<input type="checkbox"/>	<input type="checkbox"/>
Stirrer shaft			
Stirrer shaft, single mechanical seal	SB-18-14-0024	<input type="checkbox"/>	<input type="checkbox"/>
Standard direct coupling	SB-18-14-0026	<input type="checkbox"/>	
Biostat® Aplus direct coupling	BB-39240983		<input type="checkbox"/>
Standard magnetic coupling	SB-18-14-0031		
Mixing			
6-blade disc impeller	BB-8847371	<input type="checkbox"/>	<input type="checkbox"/>
3-blade segment impeller	BB-8847401	<input type="checkbox"/>	<input type="checkbox"/>
Baffle cage	BB-8846820	<input type="checkbox"/>	<input type="checkbox"/>
Aeration			
Ring sparger (bores downwards)	UNIVESSEL-00013	<input type="checkbox"/>	<input type="checkbox"/>
Ring sparger (bores upwards)	BB-8846855	<input type="checkbox"/>	<input type="checkbox"/>
Micro sparger	UNIVESSEL-00057	<input type="checkbox"/>	<input type="checkbox"/>
Aeration basket	BB-8848017	<input type="checkbox"/>	<input type="checkbox"/>
Biostat® B, B-DCU II, B-DCU (2016) exhaust cooler	UNIVESSEL-00009		
Biostat® Aplus, Bplus exhaust cooler	BB-8846880		<input type="checkbox"/>
Biostat® A exhaust cooler	BB-8822009	<input type="checkbox"/>	
Flexible adapter for exhaust cooler	BB-8844593	<input type="checkbox"/>	<input type="checkbox"/>
Biostat® A exhaust line for filter heater	BB-34164267	<input type="checkbox"/>	
Biostat® A filter heater for Univessel® Glass SU	BB-8822023	<input type="checkbox"/>	
Air inlet exhaust filter, Midisart® 2000 (12 pc)	17805-----E	<input type="checkbox"/>	<input type="checkbox"/>
Air inlet exhaust filter, Sartofluor® Capsule	5181307T5--OO--D	<input type="checkbox"/>	<input type="checkbox"/>
Filterkit (1 × Sartofluor® Capsule, 1 × Midisart® 2000 8" MNPT, 3 × Midisart® 2000 Hose Barb, 5 × Minisart® SRP15)	UNIVESSEL-KIT2	<input type="checkbox"/>	<input type="checkbox"/>

Univessel® Glass 5 L

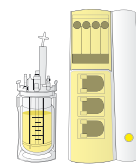

	Article number	Biostat® A (2014)	Biostat® Aplus
Spinfilter			
Spinfilter 10 µm	BB-8847448	<input type="checkbox"/>	<input type="checkbox"/>
Spinfilter 20 µm	BB-8847452	<input type="checkbox"/>	<input type="checkbox"/>
Spinfilter 75 µm	BB-8847487	<input type="checkbox"/>	<input type="checkbox"/>
Draft tube	BB-8840660	<input type="checkbox"/>	<input type="checkbox"/>
Dip tubes			
Dip tube; straight, height-adjustable, ID 4 mm	BB-8807892	<input type="checkbox"/>	<input type="checkbox"/>
Dip tube; straight, fixed, ID 4 mm	BB-8807868	<input type="checkbox"/>	<input type="checkbox"/>
Dip tube; straight, for spinfilter, ID 4 mm	BB-8808279	<input type="checkbox"/>	<input type="checkbox"/>
Dip tube; straight, height-adjustable, ID 2 mm	UNIVESSEL-00017	<input type="checkbox"/>	<input type="checkbox"/>
Dip tube; bended, height-adjustable, ID 4 mm	BB-8848635	<input type="checkbox"/>	<input type="checkbox"/>
Dip tube; for ATF connection, straight, height-adjustable, ID 12 mm	UNIVESSEL-00038	<input type="checkbox"/>	<input type="checkbox"/>
Cooling fingers and tubing set for chiller			
Standard cooling finger	UNIVESSEL-00023		
Biostat® Aplus cooling finger	BB-8847827		<input type="checkbox"/>
Biostat® A cooling finger	BB-8822026	<input type="checkbox"/>	
Tube Connection Set Biostat® A Chiller	BB-8822027	<input type="checkbox"/>	
Foam disc			
Foam disc 96/14	BB-8844467	<input type="checkbox"/>	<input type="checkbox"/>
pH sensors			
Standard pH sensor, Hamilton EasyFerm Plus, 325 mm	BB-8848657		
Standard pH sensor, Mettler, 325 mm	BB-8848693		
Digital pH sensor, Hamilton EasyFerm Bio Arc, 325 mm	UZE---0003		
Biostat® A sensor package (pH and DO) E+H, 325 mm	BB-8822012	<input type="checkbox"/>	
Biostat® Aplus pH sensor, Hamilton, 325 mm	BB-34090813		<input type="checkbox"/>
Biostat® Aplus pH sensor, Mettler, 325 mm	BB-33182574		<input type="checkbox"/>
Biostat® Bplus pH sensor, Hamilton, 325 mm	BB-8837243		
pH & Redox sensor, Hamilton EasyFerm Plus, 325 mm	BB-8844203		
pH & Redox sensor, Mettler, 325 mm	BB-8844213		

Univessel® Glass 5 L

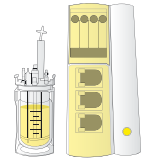

	Article number	Biostat® A (2014)	Biostat® Aplus
DO sensors			
Standard DO sensor, optical, Hamilton VisiFerm DO, 325 mm (Arc and analog)	BB-8848671		
Standard DO sensor, electrochemical, Hamilton OxyFerm DO, 325 mm	BB-8848664		
Standard DO sensor, electrochemical, Mettler, 320 mm	BB-8848677		
Biostat® A sensor package (pH and DO) E+H, 325 mm	BB-8822012	<input type="checkbox"/>	
Biostat® Aplus DO sensor, electrochemical, Hamilton, 325 mm	BB-34090823		<input type="checkbox"/>
Biostat® Bplus DO sensor, electrochemical, Hamilton, 325 mm	BB-8837233		
Turbidity sensors (connected to tower of bioreactor)			
BioPAT® Fundalux, Ø 12 mm, optical path length 1 mm	BPF5L01		
BioPAT® Fundalux, Ø 12 mm, optical path length 5 mm	BPF5L05		
BioPAT® Fundalux, Ø 12 mm, optical path length 10 mm	BPF5L10		
Trace probes (connected to BioPAT® Trace)			
BioPAT® Trace dialysis probe, 332 mm	BPT0018	<input type="checkbox"/>	<input type="checkbox"/>
BioPAT® Trace membranes for dialysis probes (Glc Lac) Standard, 5 pc.	BPT0024	<input type="checkbox"/>	<input type="checkbox"/>
BioPAT® Trace membranes for dialysis probes (Glc Lac) cellulase stable; 5 pc.	BPT0040	<input type="checkbox"/>	<input type="checkbox"/>
BioPAT® Trace membranes for dialysis probe (Eth Met), 5 pc.	BPT0047	<input type="checkbox"/>	<input type="checkbox"/>
Biomass sensors			
BioPAT® Viamass multiuse ABER sensor, 325 mm	BPV0M5L		
Temperature sensor			
Standard Pt100 with thermowell (pocket), 316 mm	BB-8848650		
Biostat® Aplus Pt100, 316 mm	BB-33197091		<input type="checkbox"/>
Biostat® Bplus Pt100, 316 mm	BB-33197040		
Level and foam sensors			
Standard level sensor, 150 mm, clip (6 mm port)	BB-8844490	<input type="checkbox"/>	
Standard level sensor, 300 mm, clip (6 mm port)	BB-8844491		
Standard foam sensor, 80 mm, clip (6 mm port)	BB-8844463		
Biostat® Aplus, Bplus foam sensor, 80 mm, incl. cable (6 mm port)	BB-8844461		<input type="checkbox"/>
Pressure sensor 0.0 – 1.0 barg, autoclavable (M26x1)	BB-8804060		

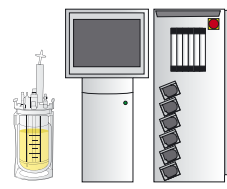
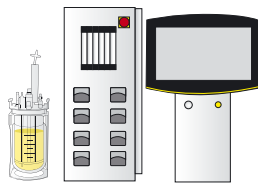
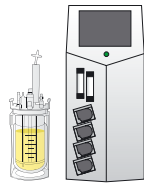
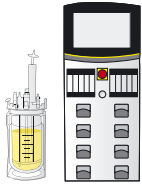

Biostat® B

Biostat® Bplus

Biostat® B-DCU
(2016)

Biostat® B-DCU II

Univessel® Glass 5 L

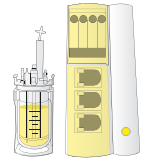

	Article number	Biostat® A (2014)	Biostat® Aplus
Sensor cables			
DO sensor connection cable, VP8-VP8, 1m	BB-8848685		
pH sensor connection cable, VP8-VP8, 1m	BB-8848681		
pH DO Arc sensor cable, M12-VP8, 1m	UZE---0005		
Level foam sensor connection cable, clip-M12, 1m	BB-8848684	<input type="checkbox"/>	
Level foam sensor connection cable, clip-clip, 1m	SB-38125129		<input type="checkbox"/>
Foam sensor connection cable, clip-M12, 1m	BB-8848683		
Pressure sensor connection cable, M12-M12, 2 m	BB-34147287		
Heating blankets			
Standard heating blanket 120 230 V	BB-8842193		
Biostat® A heating blanket, 48 VDC	BB-8822030	<input type="checkbox"/>	
Biostat® Aplus, Bplus heating blanket, 120 VAC	BB-8807551		<input type="checkbox"/>
Biostat® Aplus, Bplus heating blanket, 230 VAC	BB-8807552		<input type="checkbox"/>
Handling			
Reaction vessel fixation for cleaning	UNIVESSEL-00051	<input type="checkbox"/>	<input type="checkbox"/>
Tool- and accessory kit	UNIVESSEL-00047	<input type="checkbox"/>	<input type="checkbox"/>
Bottle support for 500 mL bottles	UNIVESSEL-00020	<input type="checkbox"/>	<input type="checkbox"/>
Integrated handle bar	UNIVESSEL-00034	<input type="checkbox"/>	<input type="checkbox"/>
Handle for installation on the head plate	UNIVESSEL-00044	<input type="checkbox"/>	<input type="checkbox"/>
Impeller angle tool	UNIVESSEL-00061	<input type="checkbox"/>	<input type="checkbox"/>

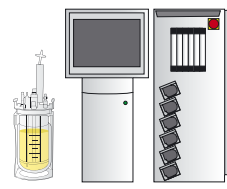
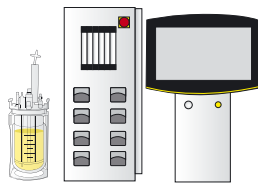
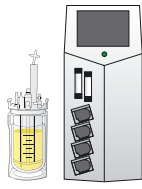
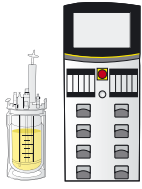

Biostat® B

Biostat® Bplus

Biostat® B-DCU
(2016)

Biostat® B-DCU II

Univessel® Glass 10 L

	Article number
Univessel® Glass	
Univessel® Glass 10 L, double wall (stand, reaction vessel, head plate)	UNIVESSEL-00004
Univessel® Glass 10 L, single wall (stand, reaction vessel, head plate)	UNIVESSEL-00008
Reaction vessel double wall	SB-18-14-0004
Reaction vessel single wall	SB-18-14-0008
Kit Univessel® Glass w/ bottom drain 10 L single wall	UNIVESSEL-00079
Kit Univessel® Glass w/ bottom drain 10 L double wall	UNIVESSEL-00082
Head plate	SB-18-14-0012
Stand (incl. support bracket)	SB-18-14-0016
Silicone support ring d 230 mm	SB-18-14-0020
O-Ring for head plate	SB-80-01-0030
Stirrer shaft	
Stirrer shaft, single mechanical seal	SB-18-14-0025
Standard direct coupling	SB-18-14-0026
Standard magnetic coupling	SB-18-14-0031
Mixing	
6-blade disc impeller	BB-8847380
3-blade segment impeller	BB-8847410
Baffle cage	UNIVESSEL-00010
Single baffle (old version)	BB-8846839
Aeration	
Ring sparger (bores downwards)	UNIVESSEL-00014
Ring sparger (bores upwards) with baffle	BB-8846863
Ring sparger (bores upwards)	BB-8807752
Micro sparger	UNIVESSEL-00058
Aeration basket	BB-8848025
Biostat® B, B-DCU II, B-DCU (2016) exhaust cooler	UNIVESSEL-00009
Biostat® Bplus exhaust cooler	BB-8846880
Flexible adapter for exhaust cooler	BB-8844593
Air inlet exhaust filter, Midisart® 2000 (12 pc)	17805-----E
Air inlet exhaust filter, Sartofluor® Capsule	5181307T5--OO--D
Filterkit (1 × Sartofluor® Capsule, 1 × Midisart® 2000 8" MNPT, 3 × Midisart® 2000 Hose Barb, 5 × Minisart® SRP15)	UNIVESSEL-KIT2
Spinfilter	
Spinfilter 10 µm	BB-8847449
Spinfilter 20 µm	BB-8847991
Spinfilter 75 µm	BB-8847495
Draft tube	BB-8840580

Univessel® Glass 10 L

	Article number
Dip tubes	
Dip tube; straight, height-adjustable, ID 4 mm	BB-8807906
Dip tube; straight, fixed, ID 4 mm	BB-8807876
Dip tube; straight, for spinfilter, ID 4 mm	BB-8840598
Dip tube; straight, height-adjustable, ID 2 mm	UNIVESSEL-00018
Dip tube; bended, height-adjustable, ID 4 mm	BB-8848636
Dip tube; for ATF connection, straight, height-adjustable, ID 12 mm	UNIVESSEL-00039
Cooling fingers	
Standard cooling finger	UNIVESSEL-00024
Foam disc	
Foam disc 96/16	BB-8844468
pH sensors	
Standard pH sensor, Hamilton EasyFerm Plus, 425 mm	BB-8848658
Standard pH sensor, Mettler, 425 mm	BB-8848694
Digital pH sensor, Hamilton EasyFerm Bio Arc, 425 mm	UZE---0004
Biostat® Bplus pH sensor, Hamilton, 425 mm	BB-8837244
pH & Redox sensor, Hamilton EasyFerm Plus, 425 mm	BB-8844204
pH & Redox sensor, Mettler, 425 mm	BB-8844214
DO sensors	
Standard DO sensor, optical, Hamilton VisiFerm DO, 425 mm (Arc and analog)	BB-8848672
Standard DO sensor, electrochemical, Hamilton OxyFerm DO, 425 mm	BB-8848665
Standard DO sensor, electrochemical, Mettler, 425 mm	BB-8848678
Biostat® Bplus DO sensor, electrochemical, Hamilton, 425 mm	BB-8837234
Turbidity sensors (connected to tower of bioreactor)	
BioPAT® Fundalux, Ø 12 mm, optical path length 1 mm	BPF5L01
BioPAT® Fundalux, Ø 12 mm, optical path length 5 mm	BPF5L05
BioPAT® Fundalux, Ø 12 mm, optical path length 10 mm	BPF5L10
Trace probes (connected to BioPAT® Trace)	
BioPAT® Trace dialysis probe, 432 mm	BPT0020
BioPAT® Trace membranes for dialysis probes (Glc Lac) Standard, 5 pc.	BPT0024
BioPAT® Trace membranes for dialysis probes (Glc Lac) cellulase stable; 5 pc.	BPT0040
BioPAT® Trace membranes for dialysis probe (Eth Met), 5 pc.	BPT0047

Univessel® Glass 10 L

	Article number
Biomass sensors	
BioPAT® Viamass multiuse ABER sensor, 425 mm	BPVOMXL
Temperature sensor	
Standard Pt100 with thermowell (pocket), 418 mm	BB-8848651
Biostat® Bplus Pt100, 418 mm	BB-33197059
Level and foam sensors	
Standard level sensor, 150 mm, clip (6 mm port)	BB-8844490
Standard level sensor, 300 mm, clip (6 mm port)	BB-8844491
Standard foam sensor, 80 mm, clip (6 mm port)	BB-8844463
Biostat® Bplus foam sensor, 80 mm, incl. cable (6 mm port)	BB-8844461
Pressure sensor 0.0 - 1.0 bar, autoclavable (M26 x1)	BB-8804060
Sensor cables	
DO sensor connection cable, VP8-VP8, 1m	BB-8848685
pH sensor connection cable, VP8-VP8, 1m	BB-8848681
pH DO Arc sensor cable, M12-VP8, 1m	UZE---0005
Level foam sensor connection cable, clip-M12, 1m	BB-8848684
Level foam sensor connection cable, clip-clip, 1m	SB-38125129
Foam sensor connection cable, clip-M12, 1m	BB-8848683
Pressure sensor connection cable, M12-M12, 2 m	BB-34147287
Heating blankets	
Standard heating blanket 120 230V	BB-8842194
Biostat® Bplus heating blanket, 120 VAC	BB-8807533
Biostat® Bplus heating blanket, 230 VAC	BB-8807534
Handling	
Reaction vessel fixation for cleaning	UNIVESSEL-00052
Tool and accessory kit	UNIVESSEL-00048
Bottle support for 500 mL bottles	UNIVESSEL-00020
Integrated handle bar	UNIVESSEL-00034
Handle for installation on the head plate	UNIVESSEL-00044
Impeller angle tool	UNIVESSEL-00061

General Accessories – Volume Independent

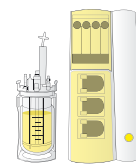

	Article number	Biostat® A (2014)	Biostat® Aplus
Sampling			
Single-use sampling solution with needle-free septum, 10 pc.	BNCHSSBF0003	<input type="checkbox"/>	<input type="checkbox"/>
Manual sampler	BB-8844623	<input type="checkbox"/>	<input type="checkbox"/>
Bypass sampler	BB-8844348	<input type="checkbox"/>	<input type="checkbox"/>
Port accessories			
Universal adapter 3.2 mm (6 mm port)	BB-8807809	<input type="checkbox"/>	<input type="checkbox"/>
4-way addition fitting, ID 0.8 mm (M26x1, 19 mm)	BB-8844313	<input type="checkbox"/>	<input type="checkbox"/>
4-way addition fitting, ID 2 mm (M26x1, 19 mm)	UNIVESSEL-00053	<input type="checkbox"/>	<input type="checkbox"/>
3-way addition fitting, ID 2 mm (PG 13.5, 12 mm)	BB-8841226	<input type="checkbox"/>	<input type="checkbox"/>
Inoculation port 6 mm (6 mm port)	BB-8844631	<input type="checkbox"/>	<input type="checkbox"/>
Inoculation port 19 mm (M26x1, 19 mm)	BB-8840601	<input type="checkbox"/>	<input type="checkbox"/>
1-channel inoculation kit (M26x1, 19 mm)	BB-8840610	<input type="checkbox"/>	<input type="checkbox"/>
Adapter M26x1 PG 13.5, standard (M26x1, 19 mm)	BB-8848630	<input type="checkbox"/>	<input type="checkbox"/>
Compression fitting for 12 mm sensors (PG 13.5, 12 mm)	UNIVESSEL-00054	<input type="checkbox"/>	<input type="checkbox"/>
Compression fitting for 12 mm sensors (M26x1, 19 mm)	BB-8891281	<input type="checkbox"/>	<input type="checkbox"/>
Burst protection complete, incl. 2 burst discs, 1 bar (M26x1, 19 mm)	UNIVESSEL-00026	<input type="checkbox"/>	<input type="checkbox"/>
Spare burst disc, 1 bar	SB-18-14-0000	<input type="checkbox"/>	<input type="checkbox"/>
Adapter M26x1 PG 13,5 - only for burst protection! (M26x1, 19 mm)	UNIVESSEL-00027	<input type="checkbox"/>	<input type="checkbox"/>
Blind plug 6 mm	BB-8807957	<input type="checkbox"/>	<input type="checkbox"/>
Blind plug PG 13.5, 12 mm	BB-8807949	<input type="checkbox"/>	<input type="checkbox"/>
Blind plug M26x1, 19 mm	BB-8807930	<input type="checkbox"/>	<input type="checkbox"/>
Miscellaneous			
Knurled head screw	SB-18-14-0021	<input type="checkbox"/>	<input type="checkbox"/>
Warning signs	SB-18-14-0027	<input type="checkbox"/>	<input type="checkbox"/>
Rubber bench pad	SB-18-14-0032	<input type="checkbox"/>	<input type="checkbox"/>
Buffer solution pH 9, 250 mL bottle	SB-34090366	<input type="checkbox"/>	<input type="checkbox"/>
Buffer solution pH 4, 250 mL bottle	SB-34090367	<input type="checkbox"/>	<input type="checkbox"/>
Buffer solution pH 7, 250 mL bottle	SB-34090368	<input type="checkbox"/>	<input type="checkbox"/>
Storage bottle 250 mL	BB-8823600	<input type="checkbox"/>	<input type="checkbox"/>
Storage bottle 500 mL	BB-8823618	<input type="checkbox"/>	<input type="checkbox"/>
Storage bottle 1 L	BB-8823675	<input type="checkbox"/>	<input type="checkbox"/>
Biostat® B motor adaptor Applikon vessel 1-7 L	UNIVESSEL-00063		
Biostat® B-DCU II, B-DCU (2016) motor adaptor Applikon vessel 1-7 L	BB-8890358		
Torque wrench for knurled head screw	UNIVESSEL-00064	<input type="checkbox"/>	<input type="checkbox"/>

Sales and Service Contacts

For further contacts, visit
www.sartorius.com

Germany

Sartorius Stedim Biotech GmbH
August-Spindler-Strasse 11
37079 Goettingen
Phone +49 551 308 0

USA

Sartorius Stedim North America Inc.
565 Johnson Avenue
Bohemia, NY 11716
Toll-Free +1 800 368 7178