

Operating Instructions

PMA.Vision

VIS1X..., VIS1X...EU

Paint-mixing Scale for Use in Potentially Explosive Atmospheres of Class I, Zone 1 and Class I, Division 1



Contents

1 About these Instructions	5
1.1 Scope	5
1.2 Target Groups	5
1.3 Symbols Used	5
1.3.1 Warnings	5
1.3.2 Other Symbols	6
2 Safety Instructions	6
2.1 Intended Use	6
2.2 Explosion Protection	7
2.3 Personnel Qualification	7
2.4 Significance of these Instructions	7
2.5 Flawlessness of the Device	8
2.6 Safety Devices	8
2.7 Damage to the Electrical Equipment	8
2.8 Working on the Electrical Equipment	8
2.9 Accessories, Consumables, and Spare Parts	9
2.10 Conduct in an Emergency	9
2.11 Personal Protective Equipment	9
2.12 Safety Instructions Concerning Installation and Operation of the Device ..	10
3 Device Description	11
3.1 Device Overview	11
3.2 Symbols on the Device	13
4 Operating Concept	14
4.1 Operating and Display Elements in the Operating Display	14
4.2 Sartorius Menu	15
4.3 Scrolling in the Display	16
4.4 Entering Figures on the Number Pad	16
4.5 Entering Text and Characters	17
4.6 Key Fadeout	17
4.7 Menu Structure	18
5 Installation	20
5.1 Scope of Delivery	20
5.2 Unpacking the Device	20
5.3 Selecting a Setup Location	20
5.4 Installing the Scale	21
5.5 Connecting the Scale	21
5.6 Establishing the Power Supply	23
5.7 Anti-theft Locking Device	25
5.8 Leveling	25
5.9 Warm-up Time	26
5.10 Starting the Scale	26
6 Operation	27
6.1 Switch Device Off (Standby)/Switch Device On	27
6.2 Sorting the List	27
6.3 Zeroing/Taring the Scale	28
6.4 Mixing without Job	28
6.4.1 Setting a Conversion Factor	29
6.4.2 Toggle between the Calculated Value and Gross Value	29
6.4.3 Mixing a Formula with Factor Calculation	29
6.5 Data Input	31

7	System Settings	32
7.1	Parameter List	32
7.2	Setting the Language	34
7.3	Weight Unit Conversion	34
7.4	Resetting the Scale	35
7.5	Protecting Menu Access with a User Password	36
8	Scale Calibration/Adjustment	38
8.1	Conducting Calibration/Adjustment Using External Calibration Weight	38
8.2	Viewing Calibration Reports	40
9	Accessing the Scale via the Network	41
9.1	Connecting to a Network with DHCP	41
9.2	Connecting to a Network with a Fixed IP Address	42
9.2.1	Configuring Network on a PC	42
9.2.2	Configuring Network on the Scale	43
9.3	Testing the Network Connection	44
9.3.1	"Ping" Command	45
9.3.2	Access via UPnP (Universal Plug and Play)	46
9.3.3	Web Browser Access	46
9.4	Changing the Device Name of the Scale	47
10	Cleaning and Maintenance	48
10.1	Cleaning	48
10.2	Servicing	48
11	Faults	49
12	Storage and Shipping	50
12.1	Storage	50
12.2	Shipping-related Tasks>Returns	50
13	Disposal	51
13.1	Information on Decontamination	51
13.2	Disposing of Device and Parts	51
13.2.1	Information on Disposal	51
13.2.2	Disposal	51
14	Serial Number Coding	52
15	Technical Data	53
15.1	General Data	53
15.2	Model-specific Data	54
15.3	Verified Models with EC Type Examination Certificate: Model-specific Technical Data	54
15.4	Device Dimensions	55
16	Accessories	56
17	Sartorius Service	57
18	Conformity & Approvals	57
18.1	EU Declaration of Conformity	57
18.2	Explosion Protection Approvals	60
18.3	EU Type Examination Certificate (Verified Models)	77

1 About these Instructions

1.1 Scope

These instructions apply to the device in the following versions:

Device	Model
PMA.Vision	<ul style="list-style-type: none"> – VIS1X... – VIS1X...EU

1.2 Target Groups

These instructions are designed for the following target groups. The target groups must possess the knowledge listed.

Target Group	Knowledge/Responsibilities
User	<p>The user is responsible for operating the device and for the associated work processes. They understand the hazards which may arise when working with the device and can avoid these hazards.</p> <p>The user is trained in the operation of the device.</p> <p>The training takes place within the scope of startup and is carried out by the operating engineer/laboratory manager or the operator of the device.</p>
Electrician	<p>A qualified electrician has the specialized training, knowledge, and experience as well as familiarity with applicable regulations to evaluate the work assigned to them and identify possible hazards.</p>
Operator	<p>The device operator is responsible for ensuring compliance with workplace health and safety regulations.</p> <p>The operator must ensure that anyone working with the device has access to the relevant information and is trained to work with the device.</p>

1.3 Symbols Used

1.3.1 Warnings

WARNING

Denotes a danger with risk that death or severe injury may result if it is **not** avoided.

CAUTION

Denotes a danger with risk that moderate or minor injury may result if it is **not** avoided.

NOTICE

Denotes a danger that can result in property damage if the risk is **not** avoided.

1.3.2 Other Symbols

- ▶ Required action: Describes actions which must be carried out.
- ▷ Result: Describes the result of the actions carried out.
- [] Text inside brackets refers to control and display elements.
- M This symbol provides information for the sale of scales verified for use in legal metrology.
In the following, the term "verified" is used to mean "verified for use in legal metrology" or "conformity-assessed."

Figures on the Operating Display

The figures in these instructions are based on "standard" scales. On verified scales, some displays and reports may deviate slightly from the figures. Where this is significant for operation, the differences will be explained in the text.

2 Safety Instructions

2.1 Intended Use

This scale is used for mixing colors and paints. The scale is always connected to the ex-link converter YCO16-Z installed outside of the potentially explosive area at all times using only the link cable supplied. The scale can be used in potentially explosive areas in Zone 2. Appropriate containers must be used for loading each type of material.

The scale is controlled via the operating display. Formulas can be written into the scale using a web application via a tablet, smartphone or PC. The PC is connected to the ex-link converter installed outside of the potentially explosive area either via a network or directly via an Ethernet cable.

The device may only be used indoors.

Only use the device with the equipment and under the operating conditions described in the Specifications. You may **not** modify the device or make any technical changes.

These instructions are part of the device. The device is intended exclusively for use in accordance with these instructions.

Any further use beyond this is considered **improper**. If the device is not used properly: The protective systems of the device may be impaired. This can lead to personal injury and property damage.

2.2 Explosion Protection

If the device is used outside the Federal Republic of Germany, the relevant national electrical codes and safety regulations must be observed. Ask your dealer or Sartorius Service Center about the guidelines that apply in their country.

Use within the scope of validity of the European ATEX Directive:

- In accordance with Directive 2014/34/EU, the model in the VIS1X series is a category 2 device, suitable for use in Zone 1 potentially explosive areas.
- The ex-link converter YCO16-Z is an associated electrical apparatus that can only be installed outside of the potentially explosive area.
- Refer to the EU Type Examination Certificates in Chapter "18.2 Explosion Protection Approvals", page 60 for the device ID codes.
Please observe the safety instructions in drawing 2028210 in Chapter "18.2 Explosion Protection Approvals", page 60.

Use in Canada and the USA:

- The intrinsically safe scales in the VIS1X model series are suitable for use in Class I, Division 1 and Class I, Zone 1.
- The ex-link converter YCO16-Z is an associated electrical apparatus that can only be installed outside of the potentially explosive area.
- Please observe Certificates of Compliance 3055566 as well as Control Drawing 2028209 in Chapter "18.2 Explosion Protection Approvals", page 60.

Use in Australia/New Zealand:

- Please observe IECEx Certificate of Conformity IECEx FME 15.0007X and Safety Instructions 2028210 in Chapter "18.2 Explosion Protection Approvals", page 60.

2.3 Personnel Qualification

All persons working on the device must possess the necessary knowledge (Description, see Chapter "1.2 Target Groups", page 5).

The actions described are addressed to the "user." If individual actions must be carried out by other target groups or by Sartorius Service personnel: The qualification required will be indicated.

2.4 Significance of these Instructions

Failure to follow the instructions in this manual can have serious consequences, e.g. exposure of individuals to electrical, mechanical or chemical hazards.

- ▶ Before working with the device: Read the instructions carefully and in full.
- ▶ If the instructions are lost: Request a replacement or download the latest version from the Sartorius website (www.sartorius.com).
- ▶ The information contained in these instructions must be available to all individuals working on the device.

2.5 Flawlessness of the Device

A damaged device or worn parts may lead to malfunctions or cause hazards which are difficult to recognize.

- ▶ Do not operate the scale if its housing, the ex-link converter, or the power supply including all connections are damaged.
- ▶ Immediately disconnect the damaged device from the power.
- ▶ Have any malfunctions or damage repaired immediately by the Sartorius Service.
- ▶ Observe the maintenance intervals (intervals and maintenance work, see Chapter "10.2 Servicing", page 48).
- ▶ Take care that the glass panel of the operating display is not damaged (e.g., by falling objects, impact, or extreme pressure).

Operating Display

- ▶ If the glass panel is damaged, disconnect the device from the power supply immediately.
- ▶ The surface of the operating display should not be touched with pointed, sharp, hard, or rough objects. You should only use the touch pen provided or your fingertips. Do not use parts of clothing (e.g., sleeves) or sponges for cleaning because these can scratch the surface (e.g., due to rivets or buttons in the sleeve, or sand in the sponge).

2.6 Safety Devices

The safety equipment on the device protects people who work with the device against the hazards and harms associated with it, e.g., electrical current.

- ▶ Do **not** remove or modify the safety devices.

2.7 Damage to the Electrical Equipment

Damage to the insulation or individual components can be fatal. Contact with parts under mains voltage represents a direct danger to life.

- ▶ Check the device for defects such as loose connections or damage to the insulation (for intervals and service tasks, see Chapter "10.2 Servicing", page 48).
- ▶ If the electrical equipment is defective, immediately switch off the power supply and contact Sartorius Service.
- ▶ Keep live parts away from liquids. Moisture can lead to short circuits.

2.8 Working on the Electrical Equipment

Work on and modifications to the electrical equipment of the device may only be carried out by Sartorius Service personnel. The device may only be opened by Sartorius Service personnel.

2.9 Accessories, Consumables, and Spare Parts

Using unsuitable accessories, consumables, and spare parts can affect the functionality and safety of the device and have the following consequences:

- Risk of injury to persons
 - Damage to the device
 - Malfunctions of the device
 - Device failure
- ▶ You should only use accessories, consumables, and spare parts supplied by Sartorius. Information on operational quality is available upon request from Sartorius.
 - ▶ Only use accessories, consumables and spare parts that are in technically perfect condition.

2.10 Conduct in an Emergency

If there is immediate danger of personal injury or equipment damage, e.g., due to malfunctions or dangerous situations, take the device out of operation immediately.

- ▶ Operate the switch on the device for emergency switch-off.
- ▶ Immediately disconnect the damaged device from the power.
- ▶ Have any malfunctions repaired immediately by Sartorius Service.

2.11 Personal Protective Equipment

Personal protective equipment protects against risks arising from the equipment and the material being processed.

Protective Equipment Designation	Explanation/Examples
Protective work clothes	Tight-fitting work clothing with low tear resistance, tight sleeves, and without any projecting parts. Protects against being drawn in by moving parts or against chemicals, heat, and injuries.
Safety gloves	Protect against chemicals, heat and injuries.
Safety glasses	Protect against substances leaking under high pressure, splashing fluids.
Safety footwear/non-slip shoes	Protect against injuries to the feet caused by mechanical effects. Protect against slipping on wet surfaces.

- ▶ Wear appropriate personal protective equipment.
- ▶ Also follow the instructions posted in the work area pertaining to personal protective equipment.

2.12 Safety Instructions Concerning Installation and Operation of the Device

- Do not expose the scale, the ex-link converter, the power supply, or the accessories supplied by Sartorius to extreme temperatures, aggressive chemical vapors, moisture, shocks, vibrations, or strong electromagnetic fields. Observe the conditions of operation described in the Specifications.
The connection cables between the devices as well as the casing on the wires inside the device housing are made of PVC. Chemicals that corrode this material must be kept away from these cables.
- Note the IP protection rating of the scale, the ex-link converter, and the power supply. Do not allow liquid penetration. The protection class specifies the suitability of equipment for various environmental conditions (moisture, foreign bodies).
- The scale and ex-link converter may only be opened by Sartorius Service with the power disconnected. Do not open the power supply.
- Avoid generating static electricity on the glass panel of the operating display and plastic casing.
- The YEPS01-USB power supply for the ex-link converter may only be connected to supply voltages of min. 90 V and max. 264 V at a frequency of 48–62 Hz.
- Observe connection data (see Chapter "15.1 General Data", page 53).
- The equipment must only be used indoors. Connect the scale and the ex-link converter YC016-Z to the equipotential bonding conductor using a suitable low resistance method. All electrical circuits are grounded and electrically connected to the metal parts of the devices. The equipotential bonding conductor of the devices must be connected properly, according to commonly accepted technical standards.
- The installation must be checked for correct function and safety by trained and qualified personnel at appropriate intervals (e.g., checking the cables for damage).
- Operating personnel must be trained to recognize faulty operating states and to be able to initiate the necessary safety measures (e.g., disconnecting the ex-link converter from the power supply).
- Lay the cables where they pose no risk of causing someone to trip.



Never close a paint can using a hammer while it is still on the weighing pan. When closing, place the paint can on a firm, stable surface.

Observe the additional safety precautions and hazard warnings in subsequent chapters.

3 Device Description

3.1 Device Overview



Fig. 1: Scale front view

No.	Name
1	Operating display (see also Chapter 4.1, page 14)
2	Support column
3	Weighing pan

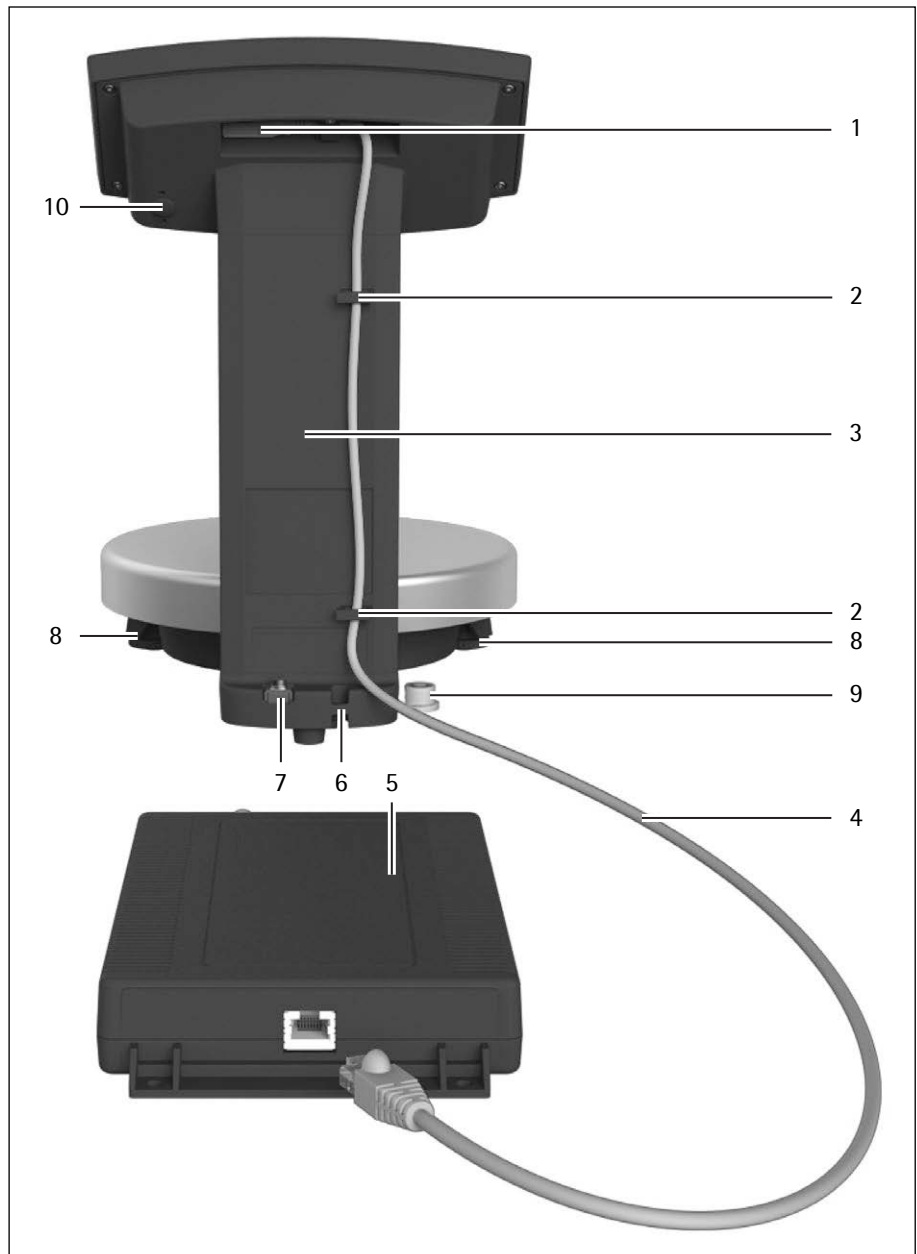

Fig.2: View of scale/ex link converter

No.	Name
1	RJ-45 socket for link cable
2	Cable holders
3	Support column
4	Link cable (blue)
5	Ex-link converter
6	Anti-theft locking device
7	Grounding terminal for equipotential bonding
8	Leveling feet (verified models only)
9	Leveling (verified models only)
10	Menu access switch

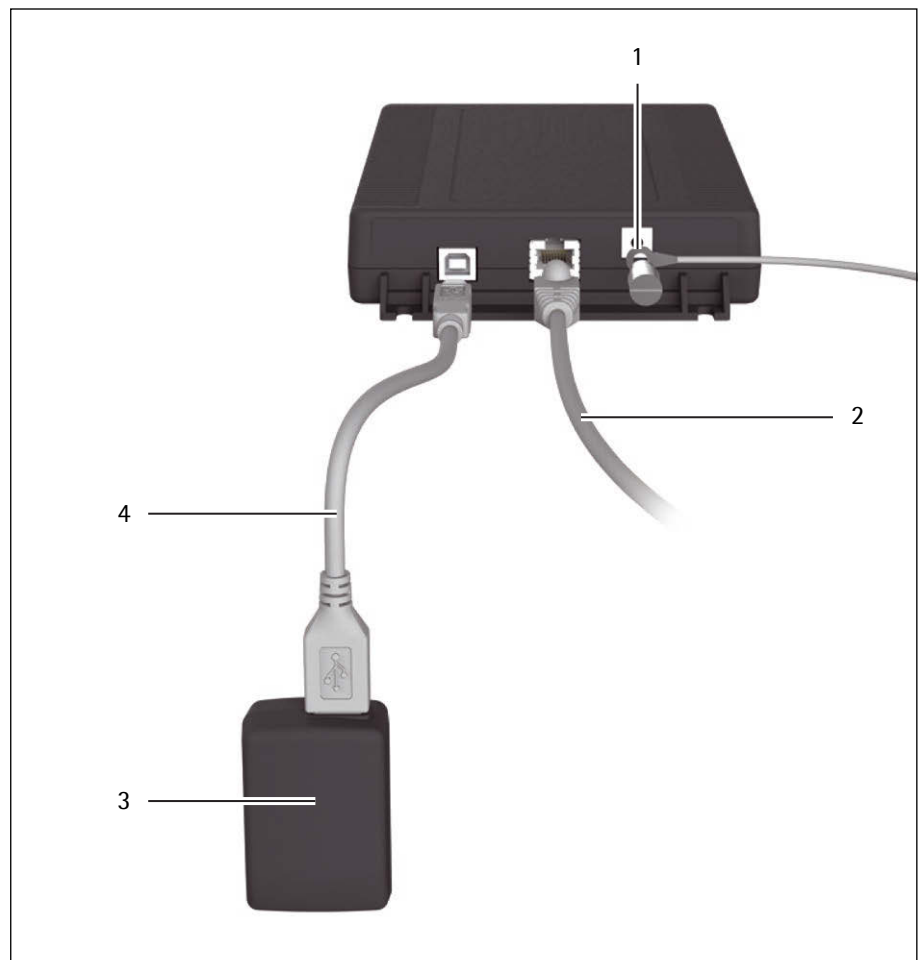

Fig. 3: View of ex-link converter/power supply

No.	Name
1	Grounding terminal for equipotential bonding
2	Ethernet cable for connecting to PC or network (optional)
3	Power supply (figure may deviate from product)
4	USB cable for connecting to power supply

3.2 Symbols on the Device

M

Seal on Scales Verified for Use in Legal Metrology:

Legislation requires that a seal be affixed to verified scales. On Sartorius devices, this seal takes the form of a sticker with the "Sartorius" logo. If the seal is removed, the validity of verification will become void and you must have your scale re-verified. The verification supplied here is for verified weighing instruments for use in the EEA. Please keep it in a safe place.

4 Operating Concept

4.1 Operating and Display Elements in the Operating Display

NOTICE Sharp or pointed instruments (such as ballpoint pens) can damage the device!

The operating display should only be operated by lightly pressing it using the tips of your fingers.

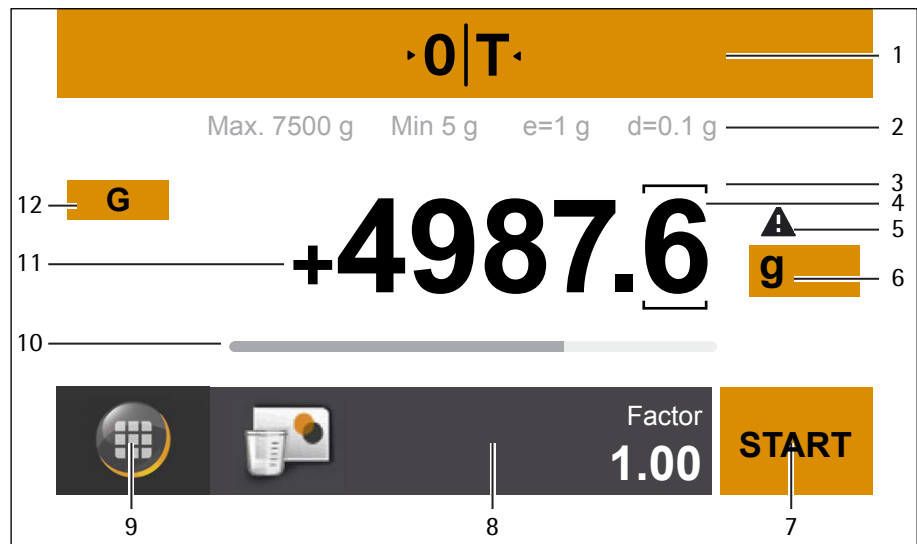

Fig. 1: Operating and Display Elements in the Operating Display

No.	Function
1	Toolbar showing currently available buttons – Zeroing/taring
2	Metrology line (additional info for minimum capacity Min and the verification scale interval e appear on verified scales)
3	In verified mode for devices where e does not equal d: The frame indicates a scale interval
4	Current weight or value measured
5	Warning symbol to indicate calculated values, negative gross values
6	Unit and stability indicator; set weight unit and display accuracy
7	Run application, such as saving the weight value of a component
8	Settings for the selected application
9	Menu key: Switch to menu or formula selection
10	Bar graph: scaled display showing capacity usage (in percent)
11	Plus (or minus) sign of the weight
12	Display value ID, e.g., "G" for gross value, "Net" for net value; switch display value for application, such as net value, total value, weight value, or calculated value

4.2 Sartorius Menu

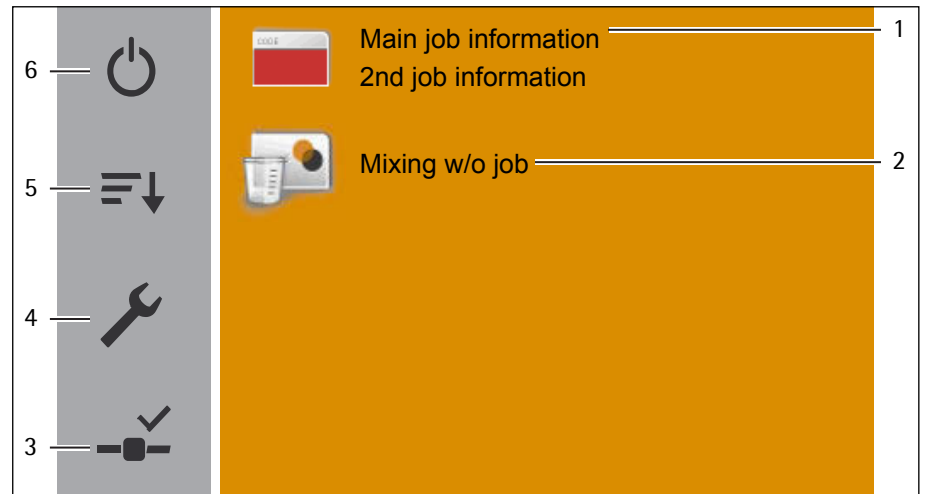





Fig.2: Sartorius Menu

No.	Symbol	Name	Description
1			Access a formula/access the formula list
2			Mixing without formula (weighing function)
3		Connection status	Displays the connection status:
			<div style="border: 1px solid black; padding: 5px;"> Error Ethernet cable not connected! <div style="text-align: right; background-color: #cccccc; padding: 2px 10px;">✓</div> </div>
			<div style="border: 1px solid black; padding: 5px;"> No connection Establishing connection <div style="text-align: right; background-color: #cccccc; padding: 2px 10px;">✓</div> </div>
			<div style="border: 1px solid black; padding: 5px;"> Connection is ready but no data transferred IP: 172.16.26.41 Device ID: PAINT <div style="text-align: right; background-color: #cccccc; padding: 2px 10px;">✓</div> </div>
			<div style="border: 1px solid black; padding: 5px;"> Connection is active Data successfully transferred IP: 172.16.26.41 Device ID: PAINT <div style="text-align: right; background-color: #cccccc; padding: 2px 10px;">✓</div> </div>

No.	Symbol	Name	Description
4		Setup	Pressing calls up the setup menu. System settings can be changed there.
5		Sort	Pressing calls up the sorting function (sorting of available formulas).
6		On/off	<ul style="list-style-type: none"> – Pressing for longer than 3 seconds switches the scale off (standby). – Pressing briefly will switch the scale on again.

4.3 Scrolling in the Display

If more than one entry is available, you can scroll up and down through the display to select the desired entry.

- ▶ To scroll, place your finger on the display and drag it slowly either up or down.
- ▷ The entries on the display move in the corresponding direction. While you are scrolling, a gray scroll bar appears on the right of the display, indicating where you are in the list of options.

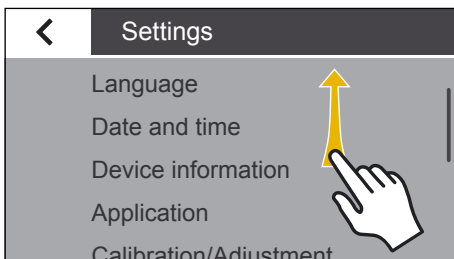

- ▶ Tap the desired entry to select it.

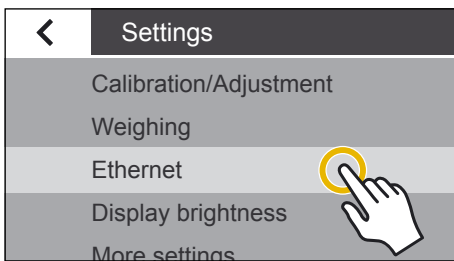

4.4 Entering Figures on the Number Pad

You can enter numeric values in the formulas or system settings. A number pad appears on the display, which is always used in the same way.

- ▶ To enter numbers, select the desired numbers one after the other.
- ▷ The entered numbers appear at the top of the display.
- ▶ To correct the last entered number, select ←.
- ▷ The number is deleted. Then enter the correct number.
- ▶ To clear the entire entered value, select **C**.
- ▶ To confirm the entry, select ✓.
- ▶ To cancel the entry, select **X**.

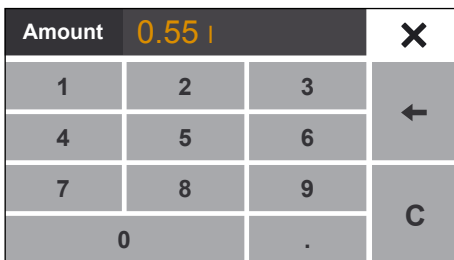

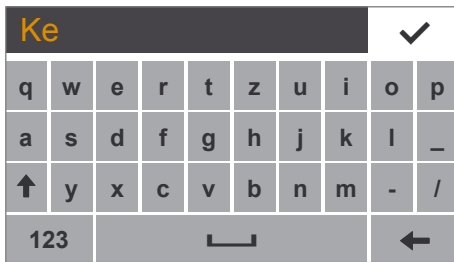

4.5 Entering Text and Characters

A keyboard will appear when you have to enter text and characters.

- ▶ Select the individual characters one after the other. The entered text appears at the top of the display. If you hold down a character for longer, the special versions of that character (umlauts, accent marks) and special characters appear.

- ▶ Use the Shift key to switch the keyboard display between uppercase and lowercase letters.

- ▶ Use the 123 key to switch the keyboard display from letters to numbers (incl. special characters).

- ▶ Use the ABC key to switch the keyboard display from numbers to letters.

- ▶ Use the back arrow key to delete the last character.

- ▶ The ✓ key ends the process and saves character input.

4.6 Key Fadeout

To prevent operating errors, only relevant functions/keys are displayed depending on the situation. This prevents most operating errors from occurring. The following buttons are only available in specific circumstances:

Key	Display
·0 T·	Only when there is a weight value within the zero setting range or a weight value larger than zero, i.e., positive.
☞	Only when a weight value larger than zero is the value saved in the memory, if the value can be saved.
START	Only when an application can be started (i.e., only when not low or high active and "Start" is permitted).

4.7 Menu Structure

Menu	Level 1	Level 2	Description Reference	
Settings	Language		Change the language of the user interface.	
	Date and time	Date	Adjusting the date.	
		Date format	Adjusting the display format.	
		Time	Adjusting the time.	
		Time format	Adjusting the display format.	
	Device information		Displays the device information.	
	Use	Autonomous database		Formulas are not deleted following the mixing process (connection status hidden).
				Formulas are deleted following the mixing process.
		Mixing without job		Display [Mixing without job] in the Sartorius menu.
				Hide [Mixing without job] in the Sartorius menu.
		Recalculation method		Selection of the recalculation method when mixing without job.
		REST protocol		Selection of the REST protocol.
		Battery backup *		There is an attempt to finish the mixing process after the power failure. A result is generated.
			No result is generated in the event of power failure.	
	Calibration/adjustment	Adjusting the weighing system*		Conduct of adjustment using an external calibration weight.
		Calibration report		Access available calibration reports.
	Weighing	Ambient conditions		Setting the ambient conditions.
		Use		Setting the application filter.
		Stability signal		Setting the sensitivity.
		Zero/tare (automatic zero)		Setting the automatic zero.
		Unit/accuracy		Setting the unit and accuracy.
Ethernet		Device ID	Changing the device ID.	
		DHCP	Switching DHCP on/off.	
		IP	Setting IP address.	
		Subnet mask	Setting subnet mask.	
		Gateway	Setting gateway.	
	Display brightness		Setting the operating display brightness.	

* Not for verified models

Menu	Level 1	Level 2	Description Reference
	More Settings	Menu access	Setting access protection for the menu.
		Set user password	Setting user password.
		Reset settings	Resets all system settings to default settings.
		Activate upload mode	Activate the upload mode.
		Activate service mode	Activate the service mode (for Sartorius Service only).

5 Installation

5.1 Scope of Delivery

Item	Quantity
Large weighing pan: Ø 233 mm	1
USB cable, 3 m	1
Power supply YEPS01-USB	1
Mains adapter set YEPS01-PSx	1
Ex-link converter	1
Link cable from converter to scale	1
Installation Instructions	1

5.2 Unpacking the Device

Procedure

- ▶ Open the packaging, making sure to remove all parts carefully.
- ▶ After unpacking the device, check it immediately for any external damage.
- ▶ If you detect any damage, proceed as directed in Chapter "12.2 Shipping-related Tasks>Returns", page 50.
- ▶ If the device is stored temporarily: Observe the information on storage (see Chapter "12.1 Storage", page 50).
- ▶ Save the box and all parts of the packaging for any future transport. All cables should be unplugged when transporting.

5.3 Selecting a Setup Location

Select the right setup location:

- Set up the device on a stable, even surface that is not exposed to vibrations.
- Maintain free access to the device at all times.
- The devices must be handled carefully according to the IP protection rating. The environment must be suitably secured.
- In the event of use in systems and under ambient conditions with higher safety requirements, you must observe the requirements and provisions applicable in your country.

Choose a location that is not subject to the following negative influences:

- Heat (heater or direct sunlight)
- Drafts from open windows, AC systems, and doors
- Extreme vibrations during weighing
- Heavy traffic areas (personnel)
- Extremely high humidity
- Electromagnetic fields
- Extremely dry air

Acclimatization

Condensation from humidity can form on the surfaces of a cold device when it is brought into a warm area. You should therefore let a device that has been disconnected from its power source acclimatize for approximately 2 hours before reconnecting it to the supply voltage.

5.4 Installing the Scale

NOTICE

The scale must be disconnected from the power supply for all assembly work.

Procedure

- ▶ Place the weighing pan onto the scale from above.



5.5 Connecting the Scale

Procedure

- ▶ Insert the link cable plug into the socket on the back of the display.



- ▶ Lay the link cable through the cable holders on the back of the scale.





- ▶ Connect the link cable to the ex-link converter.

Connecting the Grounding Cable

This explosion-protected system should be set up according to commonly accepted technical standards. The applicable national electrical code and safety regulations for your particular country must be observed.

Before commissioning the scale, a check must be carried out by or under the supervision of a qualified electrician to ensure that the system is in good working order.

Check whether or not the competent authorities (e.g. industrial supervisory board) need to be informed. It is also necessary to carry out inspections of the system during operation.

Inspection intervals should be such that any significant defects that may occur can be identified in good time. Inspections should be carried out at least once every three years. The applicable requirements and guidelines should also be observed during operation.

Establish a low-resistance connection from the scale and the ex-link converter to a customer-supplied equipotential bonding conductor connection via the equipotential bonding conductor connections (PA) on the device using a suitable grounding cable with a gage of at least 4 mm² (not included).

Installation must be carried out properly by trained personnel and according to commonly accepted technical standards. The system should only be operated for the first time when it is certain that the area is not potentially explosive.

If deviations are evident during startup due to transport damage (e.g. no display, no backlighting), disconnect the scale from the power supply and contact the Sartorius Service Center.

Connect the scale to the equipotential bonding conductor using an equipotential bonding cable with a gage of at least 4 mm².

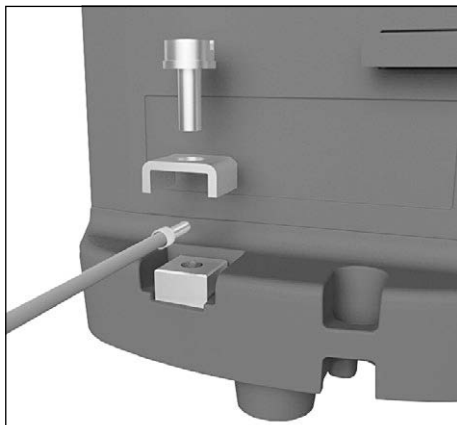

- ▶ Connect the cable lug of the equipotential bonding cable to the grounding terminal of the scale.

- ▶ Connect the equipotential bonding cable to the customer-supplied equipotential bonding conductor.

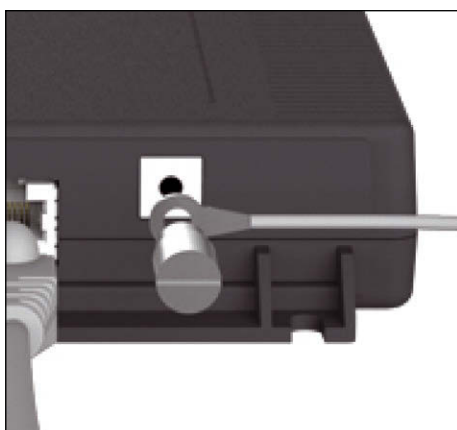

Connect the ex-link converter to the equipotential bonding conductor using another equipotential bonding cable with a gage of at least 4 mm².

- ▶ Connect the cable lug of the equipotential bonding cable to the grounding terminal of the ex-link converter.

- ▶ Connect the equipotential bonding cable to the customer-supplied equipotential bonding conductor.

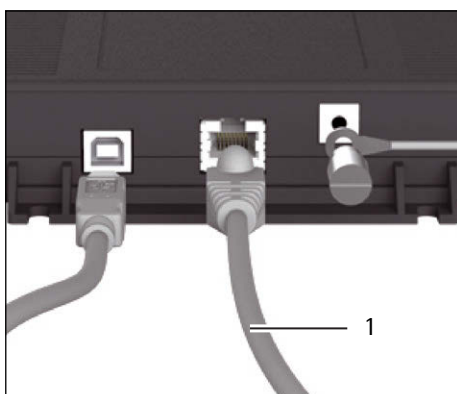

Connecting a PC/Notebook

- ▶ Plug an Ethernet cable (1) into the Ex-Link converter and connect the cable to a Windows PC (direct connection) or to a network.

5.6 Establishing the Power Supply

NOTICE Make sure that the voltage rating printed on the power supply is identical to your local supply voltage. The scale is connected to the power supply using the power supply YEPS01-USB (see Chapter "16 Accessories", page 56), which is supplied with mains adapters for use in various countries. If the stated supply voltage or the plug design of the power supply does not comply with your country's standard then please inform your nearest Sartorius representative.

Power supply assembly is described in the following.

Installing Power Supply

- ▶ **⚠ WARNING** Lethal electric shock and equipment damage due to incorrect power plug adapter! Only use the country-specific power plug adapter. Never plug the power plug adapter into the socket when it is disconnected from the power supply.
- ▶ Select the correct mains adapter for your mains power supply. The mains adapter must be suitable for use with the wall outlet at the installation site.

Mains adapter sets

Bag	Region/country
YEPS01-PS1	<ul style="list-style-type: none"> - USA and Japan (US+JP) - Europe (EU) - United Kingdom (GB)
YEPS01-PS6	<ul style="list-style-type: none"> - Argentina (AR) - Brazil (BR) - Australia (AU) - South Africa (ZA)
YEPS01-PS7	<ul style="list-style-type: none"> - China (CN) - India (IN) - Korea (KR)

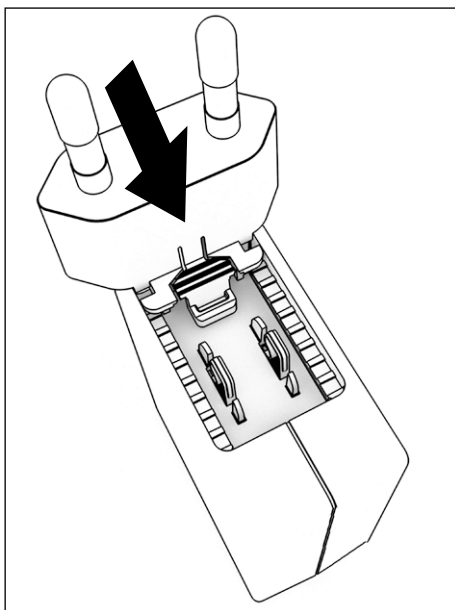

- ▶ Insert the power plug adapter into the power supply. The grooved button must be facing upwards.
- ▶ Push the power plug adapter as far as you can until it clicks into place.
- ▶ Check whether the power plug adapter is securely locked in place by pulling it gently.
- ▷ If the power plug adapter does not move, it is locked in place.

Removing/Replacing the Mains Adapter

- ▶ Press the grooved button from above and pull back on the mains adapter.
- ▶ Push the power plug adapter out of the power supply and remove it.

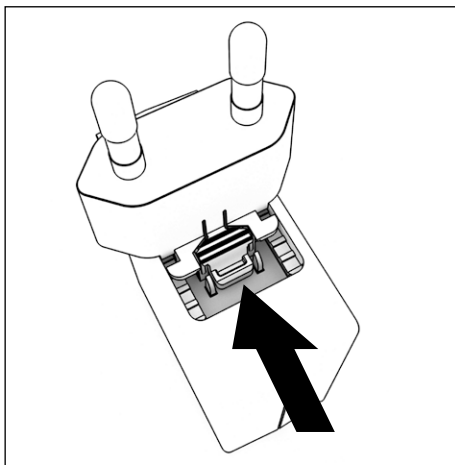

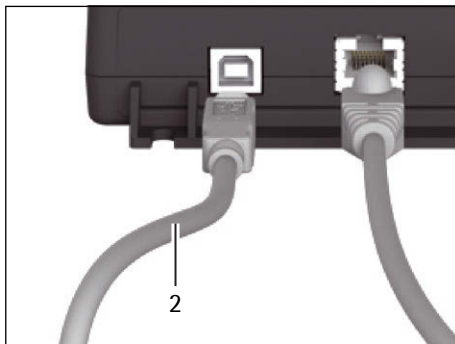

Connection to Power Supply

- ▶ Insert a USB cable (2) into the ex-link converter.

- ▶ Insert the USB cable into the YEPS01-USB power supply.
- ▶ Plug the power supply into a wall outlet (supply voltage).

5.7 Anti-theft Locking Device



- ▶ If required, secure the scale at the back.

5.8 Leveling

Leveling for Verified Models

Leveling the scale compensates for slant or unevenness at the place of installation. The scale must be perfectly horizontal to ensure consistent, reproducible weighing results.

The scale needs to be re-leveled and then adjusted if necessary each time its setup location is changed.

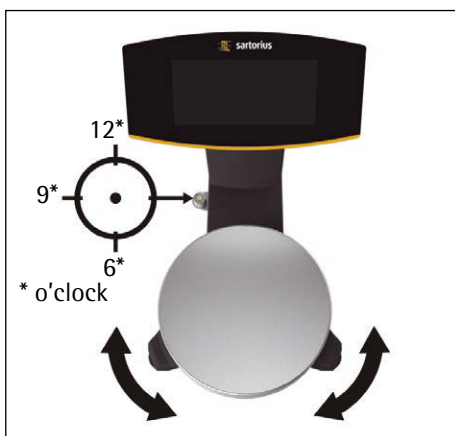

- ▶ Turn the two leveling feet as shown in the illustration until the air bubble is centered within the circle of the level indicator.
 - Air bubble at "12 o'clock:" Turn both feet clockwise.
 - Air bubble at "3 o'clock:" Turn the left foot clockwise and the right foot counterclockwise.
 - Air bubble at "6 o'clock:" Turn both feet counterclockwise.
 - Air bubble at "9 o'clock:" Turn the left foot counterclockwise and the right foot clockwise.

5.9 Warm-up Time

To ensure accurate results are delivered, the scale must warm up for at least 30 minutes after initial connection to the power supply. Only then will the device have reached the required operating temperature.

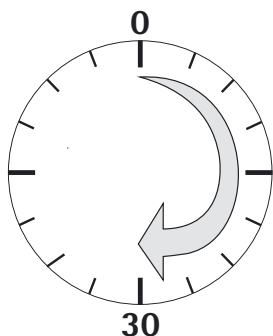
M

Using a Scale Verified for Use in Legal Metrology:

Ensure that there is a warm-up time of at least 24 hours after initial connection to the power supply.

5.10 Starting the Scale

The scale starts automatically after the power supply is connected. If there are no formulas available, then the weighing display appears directly (mixing without job, see Chapter "6.4 Mixing without Job", page 28). Otherwise, the Sartorius menu appears. The default language for the display text is English. To change the language, see Chapter "7.2 Setting the Language", page 34.

The following conditions must be observed to obtain correct weighing results:

- Level the scale (for verified models).
- Consider the warm-up time.
- Carry out a calibration/adjustment of the scale on a regular basis (see Chapter 8, page 38).

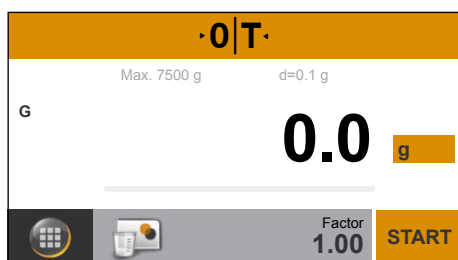

6 Operation

6.1 Switch Device Off (Standby)/Switch Device On



- ▶ Select the [Menu Key] at the bottom left of the main screen on the display.

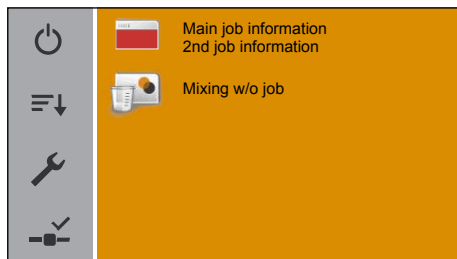

- ▶ The Sartorius menu is displayed.



- ▶ In the Sartorius menu, hold down the [On/Off] button for 3 seconds.
- ▶ The device goes into standby mode.

Switching on the device



- ▶ Press the [On/Off] button in the operating display.
- ▶ The device switches on.

6.2 Sorting the List

Received formulas can be sorted alphabetically or by date.



- ▶ Select the [Sort] button in the Sartorius menu.

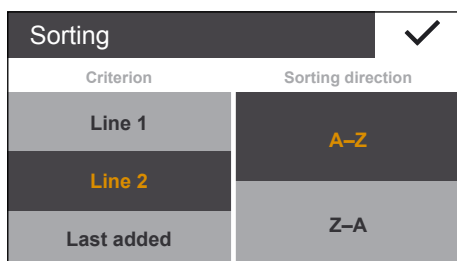

- ▶ The [Sorting] settings window appears.

Sorting alphabetically

- ▶ Select [Line 1] in order to sort the formulas according to line 1.
- ▶ Select [Line 2] in order to sort the formulas according to line 2.
- ▶ Select either [A-Z] or [Z-A] to choose the sorting order.
- ▶ Select ✓ to confirm.

Sorting by date

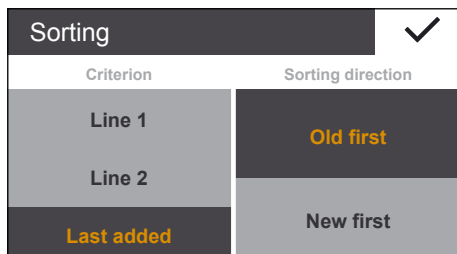

- ▶ Select [last added] to sort by date.
- ▶ Select either [Old first] or [New first] to choose the sorting order.
- ▶ Select ✓ to confirm.

6.3 Zeroing/Taring the Scale

- ▶ Remove the load from the scale.
 - ▶ Select [**·0|T·**] (1) to zero the scale.
- All weight values are measured based on this zero point (zeroing within $\pm 2\%$ of the weighing range around the zero point).

▷ The scale is zeroed and the calculation factor is reset.

- ▶ Place an empty container on the scale, if weighing with containers.
- ▶ Select [**·0|T·**] (1) to tare the scale.

The scale displays zero again after being tared. The tared value is subtracted from the overall weighing range of the scale. The scale can be tared throughout its entire weighing range.

▷ The scale is tared and the calculation factor is reset.

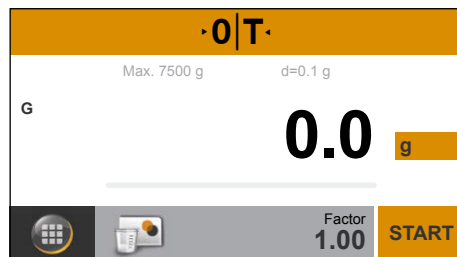
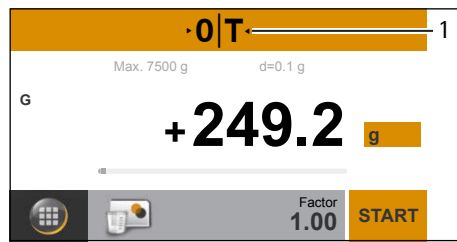

6.4 Mixing without Job

- ▶ Select the [Mixing w/o job] button in the Sartorius menu (1).
- ▷ The [Weighing] application appears.

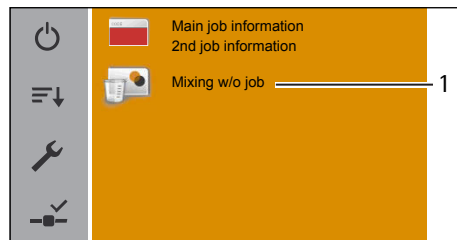

- ▶ Remove the load from the scale.
- ▶ Select [**·0|T·**] (1) to zero the scale.



▶ Place the sample on the weighing pan.

You can read the measured value as soon as the weight value (1) stops changing and the unit is displayed.

The scale stability is displayed as soon as the weighing result is constant within a defined range. Until stability is reached, the measured value is shown in gray on the display and only turns black once the scale is deemed stable.

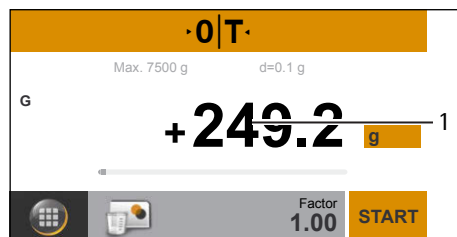

6.4.1 Setting a Conversion Factor

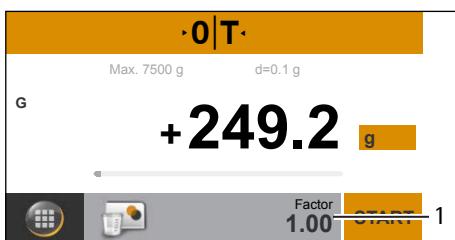

- ▶ Select the factor (1) in the weighing display.
- ▶ The [Conversion factor] menu opens.

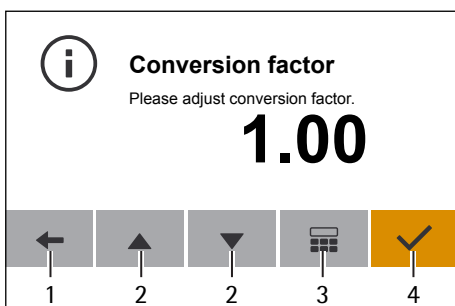

- ▶ Use the keys (2) to adjust the conversion factor gradually.
 - Under 1.0: Interval 0.01 (up to 0.10)
 - Over 1.0: Interval 0.1 (up to 6.00)
- ▶ Alternatively, enter the conversion factor directly (3).
- ▶ Select ✓ to confirm (4).
- ▶ Select ← (1) to cancel the entry.

6.4.2 Toggle between the Calculated Value and Gross Value

The figure shows the display of the calculated value (1).

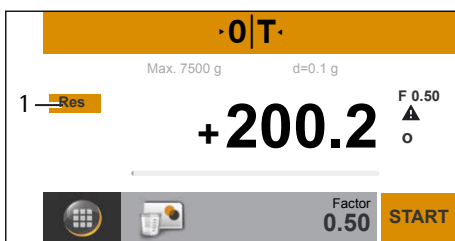

- ▶ Select [Res] (1) in order to display the gross value.

The figure shows the display of the gross value [G] (1).

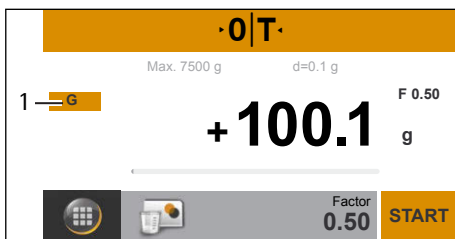

- ▶ Select [G] (1) in order to display the calculated value.

6.4.3 Mixing a Formula with Factor Calculation

The factor calculation enables you to weigh in amounts that are smaller or larger than that of your basic formula for a specific paint color (e.g., 250 ml of a 1 l formula). The conversion factor can be set between 0.1 and 6.0.

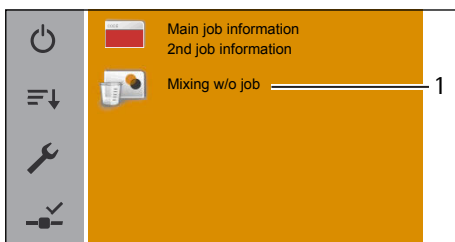

- ▶ Select the [Mixing w/o job] button in the Sartorius menu (1).
- ▶ The [Weighing] application appears.

Mixing a Formula with Factor Calculation (example)

Suppose you want to weigh 500 ml for a basic formula that has a total volume of 1 l, and you don't want to have to manually recalculate the individual components of the formula.

The basic formula for 1 liter:

200 g 1st component
 + 100 g 2nd component
Total: 300 g

► Place the empty container on the weighing pan.

- Select [**·0|T·**] (1) to zero/tare the scale.
- Set a conversion factor of 0.5 (2) (see Chapter 6.4.1, page 29).
- Select [**START**] (3) to start the formula.



- Slowly add the first component "200 g" of the formula until the display shows [200 o] (1).
- Select [Component takeover] (2).

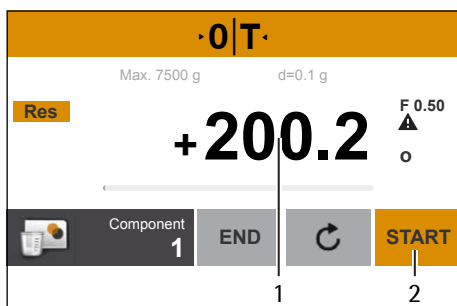

Toggle between the Current Component and the Total Value

The figure shows the display of the current component 2.

- Select [Res] (1) in order to display the total weighed value.

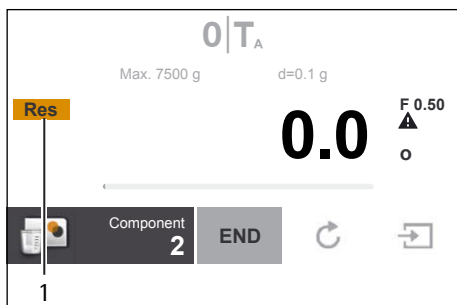

- The figure shows the total weighed value [200 o] of component 1.

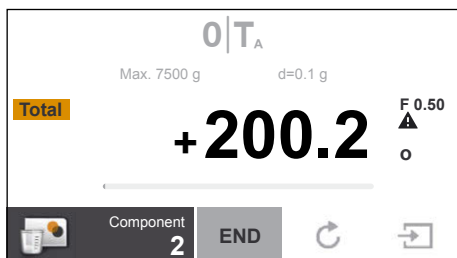

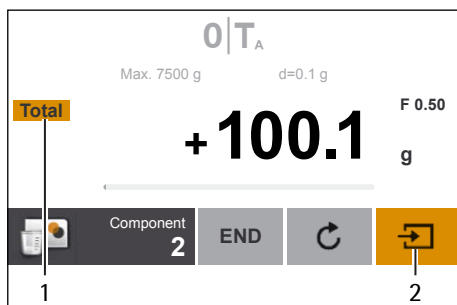

- ▶ Add the second paint component "100 g" until the display shows [100 o, component value] (1) or [300 o, total weighed value].
- ▶ Select [Component takeover] (2).

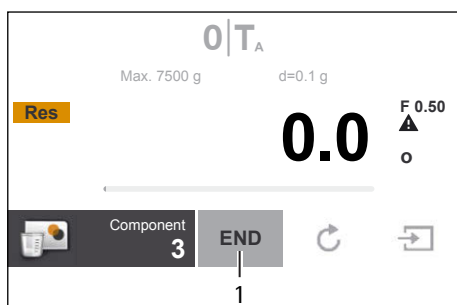

- ▶ Select [END] (1) in order to finish the formula.

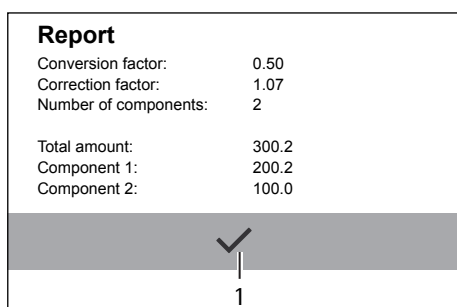

According to the display, 300 o was poured in, but the container actually contains 150 g by weight in accordance with the factor you selected.

- ▶ Select ✓ to confirm (1).

6.5 Data Input

The data input (formulas) is carried out via Webservices (see "PMA.Vision web services" guide).

7 System Settings

7.1 Parameter List

Parameter	Setting values	Explanation
Language	English	
	German	
	French	
	Spanish	
	Italian	
	Japanese	
	Russian	
	Chinese	
	Polish	
	Portuguese	
	Korean	
	Turkish	
	Hungarian	
	Dutch	
Serbian		
Slovenian		
Date format	DD-MMM-YYYY	Day.Month.Year
	MMM-DD-YYYY	Month/Day/Year
	YYYY-MM-DD (ISO)	Year-Month-Day, according to ISO standard.
Time format	24 h	
	12 h (AM/PM)	
Autonomous database	On	Formulas will not be deleted following the mixing process (connection status hidden).
	Off	Formulas are deleted following the mixing process.
Mixing without job	On	Display [Mixing without job] in the Sartorius menu.
	Off	Hide [Mixing without job] in the Sartorius menu.
Recalculation method	Cumulative	
	Individual	
REST protocol		Selection of the REST protocol
	HTTP	Old protocol (web browser entry)
	JSON	JSON (Standard)
	XML	
Battery backup	Yes, enable	There is an attempt to finish the mixing process after the power failure. A result is generated.
	No	No result is generated in the event of power failure.

Some selection options are not available for verified models.

Parameter	Setting values	Explanation
Ambient conditions	Stable	Stable environment.
	Unstable	The effects of operation in unfavorable ambient conditions such as drafts or vibration can be filtered out by adapting measuring time for the weighed values.
Use	Weighing	The display responds very quickly to large load changes. The display responds more slowly to small changes in weight (in the digit range). This setting is suitable for normal weighing.
	Filling weight	The display responds quickly to small changes in weight, making it faster and more accurate for additional dosing and container filling functions.
Stability signal	Extremely precise	The scale stability is displayed as soon as the weighing result is constant within a defined range. Until stability is reached, the measured value is shown in gray on the display and only turns black once the scale is deemed stable.
	Precise	
	Fast	
Automatic zero	On	Changes of a set fraction of scale intervals per second starting from the display zero point are automatically zeroed.
	Off	
Unit/accuracy		
Unit	g	Display in grams.
	p	Display in parts per pound.
Accuracy	All digits	Display with all available points.
	Polyrange	Number of points changes dynamically.
Display brightness	Bright	Sets the display brightness to 100%.
	Medium	Sets the display brightness to 60%.
	Eco Mode	The brightness is reduced after 2 min. of inactivity.
Menu access	Full	Full access to the menu.
	Read only	Access to the menu is protected with a user password.

Some selection options are not available for verified models.

7.2 Setting the Language



- ▶ Select the [Menu Key] at the bottom left of the main screen on the display.

- ▶ The Sartorius menu is displayed.

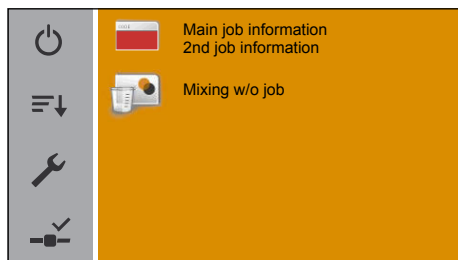

- ▶ Select the [Setup] button in the Sartorius menu.

- ▶ The [Settings] window appears.
- ▶ Select [Language] or the top entry in the list.

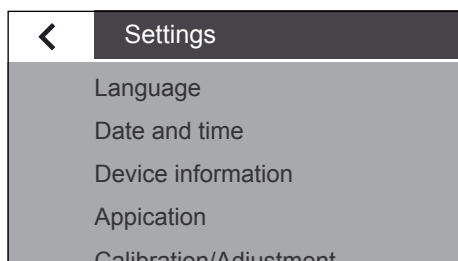

- ▶ The [Language] settings window appears.
- ▶ Select the desired language, such as Deutsch (German).
- ▶ Select ✓ to confirm.
- ▶ The display changes directly to the desired language.
- ▶ Select ◀ to return to the menu.

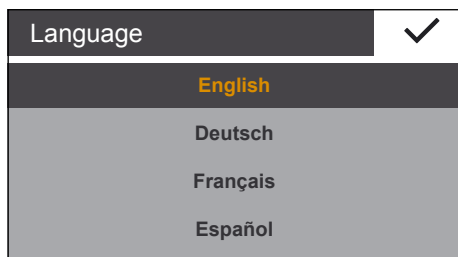

7.3 Weight Unit Conversion

You can configure the weight unit and accuracy of the weight value displayed. Access to convert the unit and the resolution is only possible if the calculation factor = 1.00. This can be forced via zeroing/taring.

M

Not all units can be selected on scales used for legal metrology. The user can only switch between metric units (e.g., milligram, gram, kilogram).

- ▶ Select the unit button (1) in the weighing display.
- ▶ The [Unit/Accuracy] menu appears.

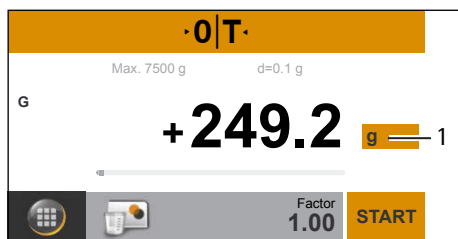

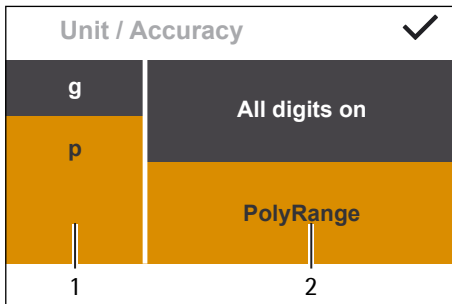

- ▶ Select the unit (1) to be used to display the weighing result.
- ▶ Select the display accuracy (2) to be used to display the weighing result.
- ▶ Select ✓ to confirm.
- ▶ The weighing display appears with the changed settings.

This setting remains until the selection is changed.

Conversion Factors for Weight Units

The table contains common weight units and their conversion factors in relation to the gram. The scale can work in the following units as and when needed (with verified scales, this is only possible if the country's laws regarding legal metrology and verification permit this):

Unit	Factor	Display
Grams	1.00000000000	g
Parts per pound	1.12876677120	p

M Some weight units and accuracy settings may be blocked from use in verified scales, depending on national laws regarding legal metrology and verification.

M Depending on the country-specific model version, not all weight units listed may be available.

7.4 Resetting the Scale



- ▶ Select the [Setup] button in the Sartorius menu.

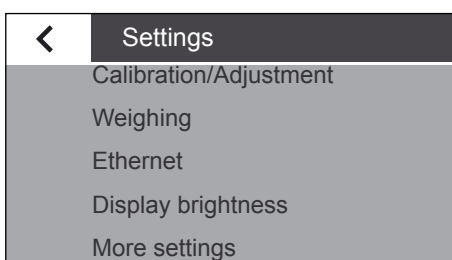

- ▶ The [Settings] window opens.
- ▶ Select [More settings].

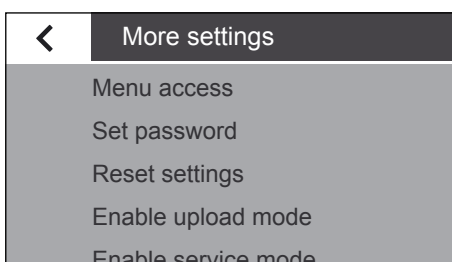

- ▶ Select [Reset settings].

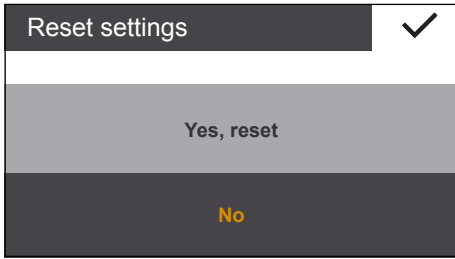

- ▶ Select [Yes, reset] in order to reset all system settings to the default settings.
- ▶ Select ✓ to confirm.

- ▶ Confirm the security prompt [All formulas and results will be deleted. Do you want to proceed?].

7.5 Protecting Menu Access with a User Password



- ▶ Select the [Setup] button in the Sartorius menu.

Block access

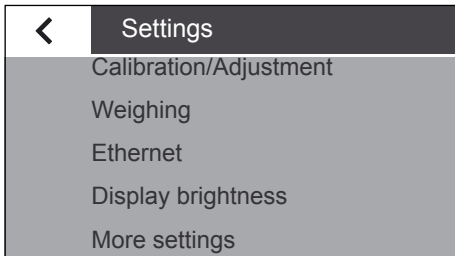

- ▶ The [Settings] window opens.
- ▶ Select [More settings].

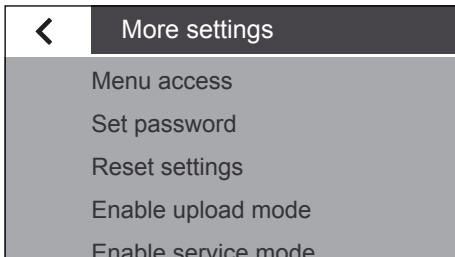

- ▶ Select [Menu access].

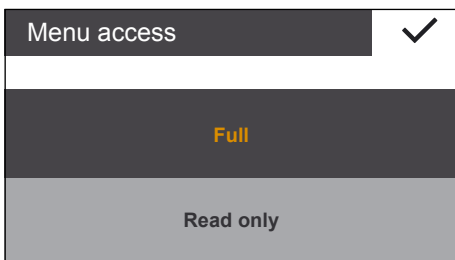

- ▶ Select [Read only], in order to protect access to the menu.
- ▶ Select ✓ to confirm.

Set user password

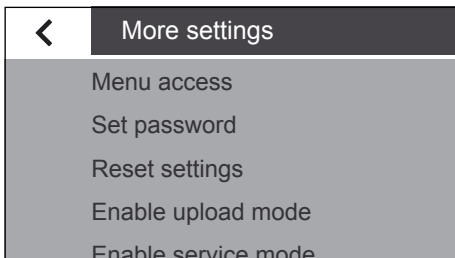

- ▶ In the [More settings] menu, select [Set password].

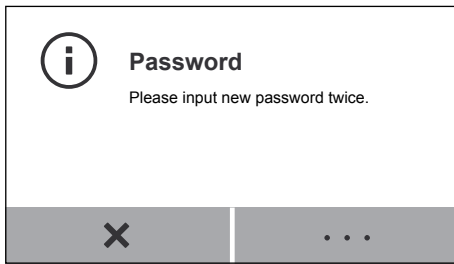

▶ Select [...].

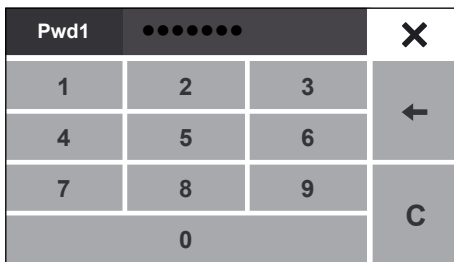

▶ Enter a number as the password.

▶ Enter the same password again to ensure correct entry.

▷ The new password is only active once you have returned to the first level of the menu.

To change the password, the old password must first be entered.

A new password can then be set.

To completely delete the password and allow access without password protection, leave the entry blank.

Contact the Sartorius Service Center if you forget the password.

8 Scale Calibration/Adjustment

During calibration, an external calibration weight is used to determine how much the displayed value deviates from the actual measurement value. This deviation is compared against a preset target value. The subsequent adjustment corrects this deviation or reduces it to the permissible error limits.

M Before using a verified scale for legal metrology, calibration/adjustment must always be carried out at the scale setup location. Depending on the area of use, the function for external adjustment may be blocked in some countries due to national legislation. Please observe the Sartorius notes on legal metrology. Please contact Sartorius Service or the national calibration authorities if you have any questions.

To achieve the highest accuracy possible, regularly calibrate and adjust the scale, e.g.:

- daily after switching on the scale,
- each time the scale is leveled,
- each time ambient conditions have changed (temperature, humidity, or air pressure),
- each time the scale is set up at a new location or moved in its current location.

8.1 Conducting Calibration/Adjustment Using External Calibration Weight

An external calibration weight is required for this function. Please note the tolerance of the calibration weight being used.

- ▶ Make sure that the weighing pan is empty.
- ▶ Select the [Setup] button in the Sartorius menu.
- ▷ The [Settings] window opens.



- ▶ Select [Calibration/adjustment] (1).
- ▷ The [Calibration/Adjustment] window opens.

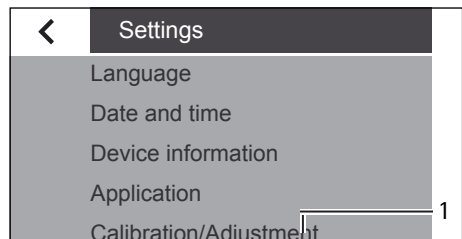

- ▶ Select [Weighing system adjustment] (1).
- ▷ The [Calibrate scale] window appears.

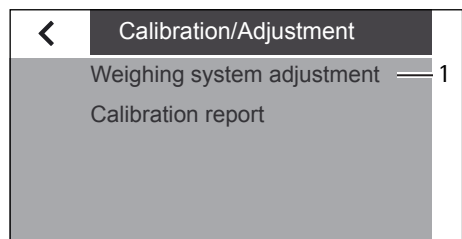

- ▶ Select [CAL: External] (1).

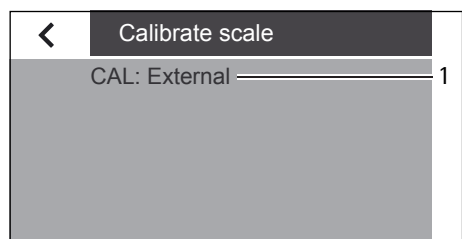

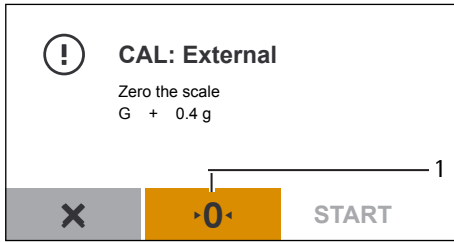

- ▶ Select **0** to zero the scale.

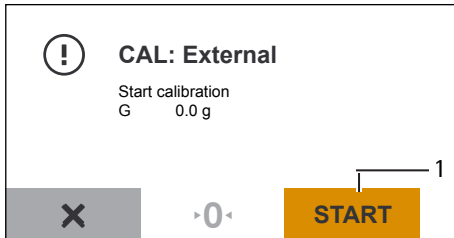

- ▶ Select [START].

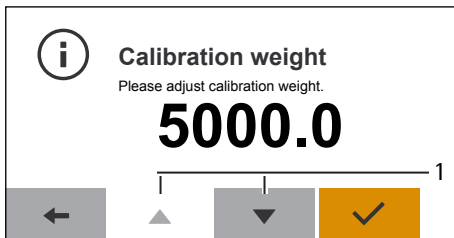

- ▶ Enter the calibration weight (1).

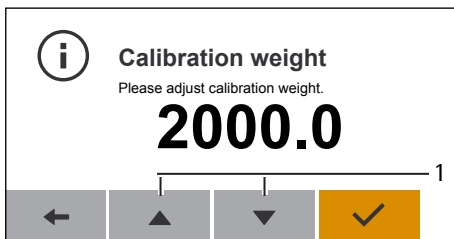

- ▶ Select **✓** (1) in order to confirm the entry.
- ▶ A message appears on the display, prompting the user to place the calibration weight on the weighing pan.

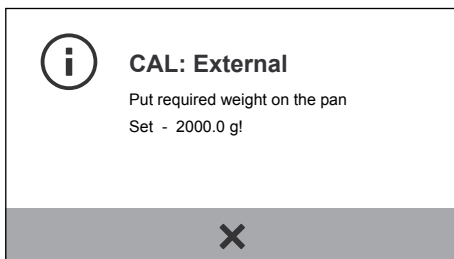

- ▶ Place the calibration weight on the weighing pan.
- ▶ Calibration starts automatically.

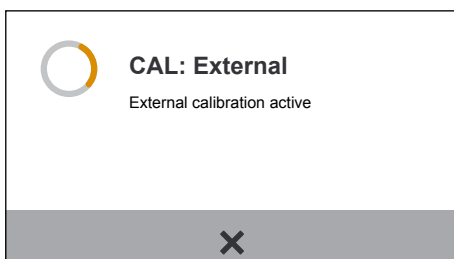

The calibration is performed.

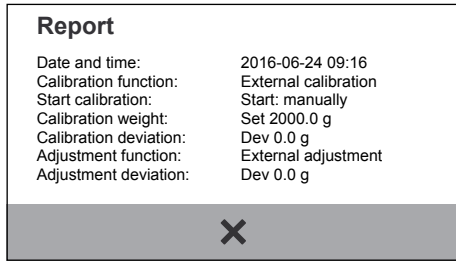

▷ A report appears on the display.
 The report indicates the deviation identified during calibration. The report also gives the result of the adjustment process.

- ▶ Select ✕ in order to close the report window.
- ▷ The scale is now calibrated and adjusted.

Information on potential errors can be found in Chapter "11 Faults", page 49.

8.2 Viewing Calibration Reports

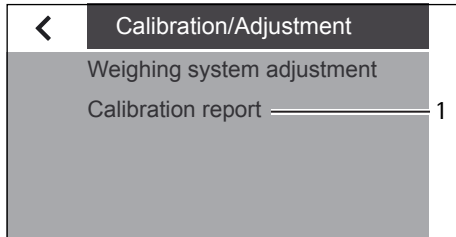

- ▶ Select [Calibration report] (1) in the [Calibration/adjustment] window.
- ▷ The [Calibration report] window opens.

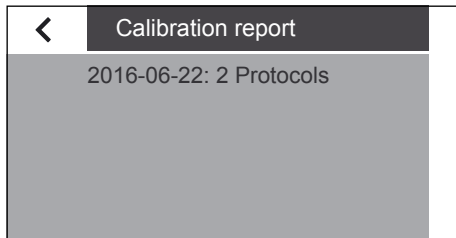

The current reports are listed in the [Calibration report] window.

- ▶ Select the relevant entry to display the report.

9 Accessing the Scale via the Network

9.1 Connecting to a Network with DHCP

Usually, the IP address on a network is assigned by a DHCP server (Dynamic Host Configuration Protocol). A prerequisite for this is that DHCP mode is enabled on the scale.

- ▶ Press the  button to call up the "Settings" menu.
- ▶ Go into the submenu "Ethernet".

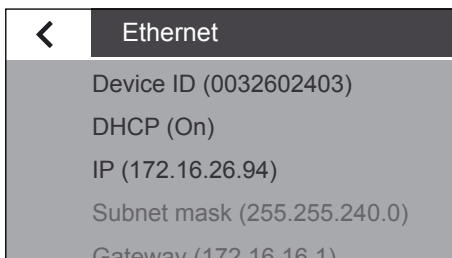
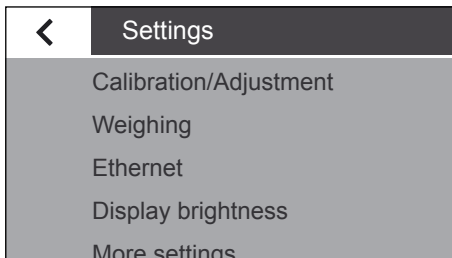

If the display says "DHCP (On)", the settings are correct.

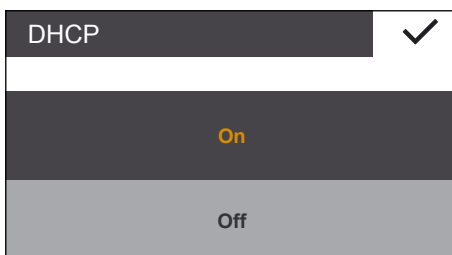

- ▶ If not, go into the submenu "DHCP".
- ▶ Select "On".
- ▶ Confirm with the  key.
- ▶ The DHCP mode is now turned on.

When you switch on the scale, the scale is automatically assigned an IP address by the DHCP server.

- ▶ Check the network connection (see Chapter 9.3, page 44).

9.2 Connecting to a Network with a Fixed IP Address

The following settings must be made to connect the scale to a network with fixed IP addresses:

9.2.1 Configuring Network on a PC

- ▶ Open the Network and Sharing Center on your Windows PC:
Start -> Control Panel -> Network and Sharing Center

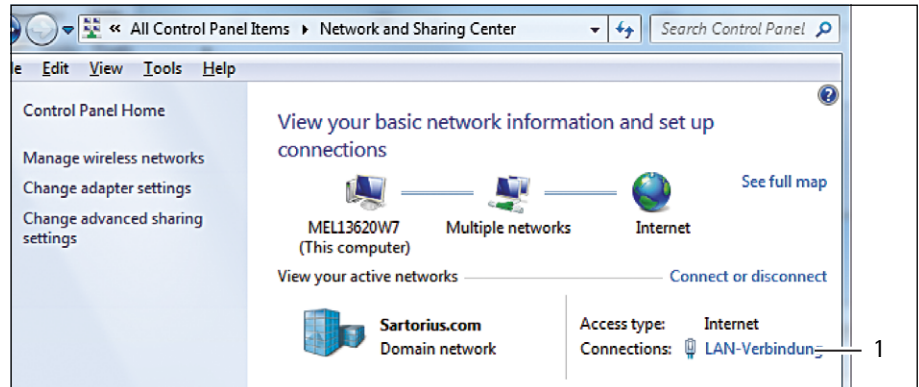

- ▶ Open the LAN connection (1).

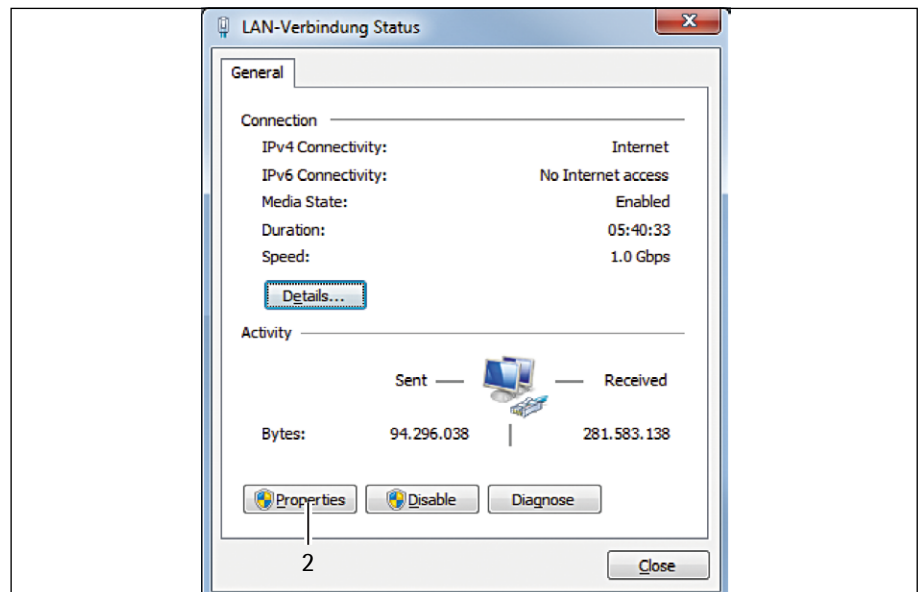

- ▶ Call up the properties (2) of the LAN Connection.

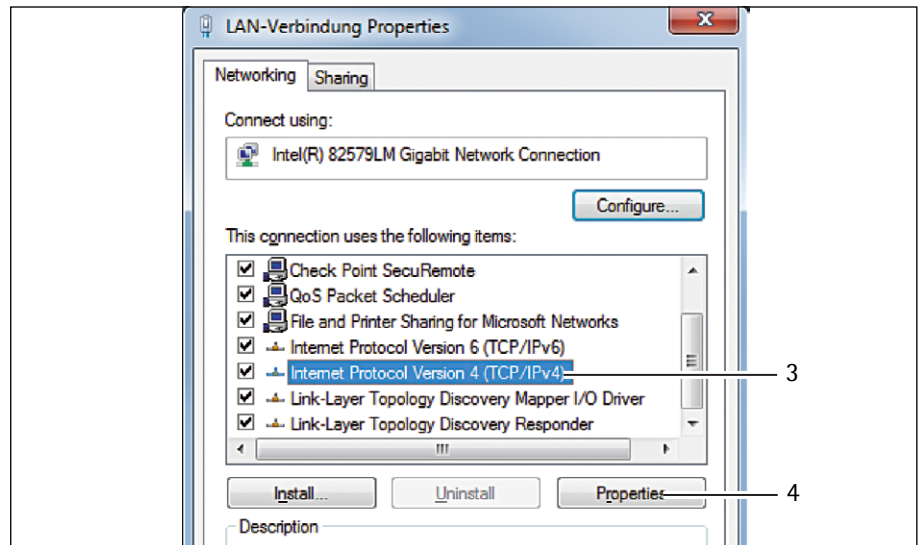

- ▶ Select the entry "Internet Protocol Version 4" (3) from the list.
- ▶ Open the properties (4).

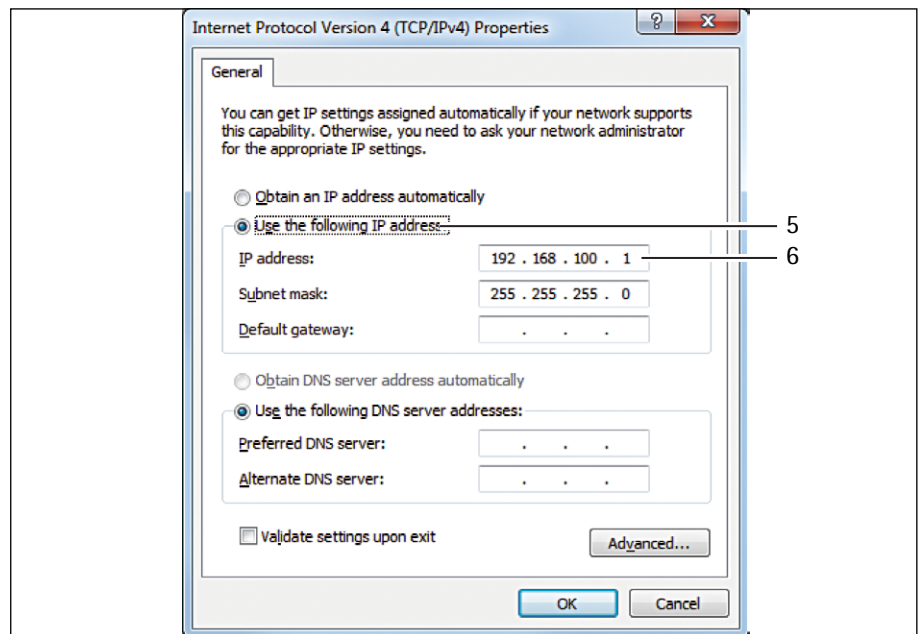

- ▶ Select "Use the following IP address" (5).
- ▶ Enter the IP address of the network connection (6).
- ▶ Confirm your entry with "OK" and close the following window with "OK".

9.2.2 Configuring Network on the Scale

- ▶ Press the "i" button to call up the "Settings" menu.
- ▶ Go into the submenu "Ethernet".

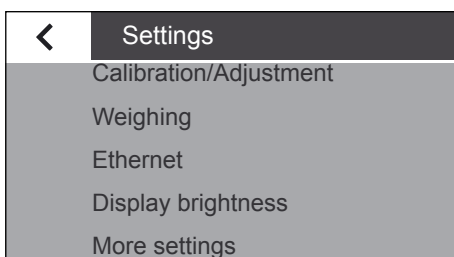

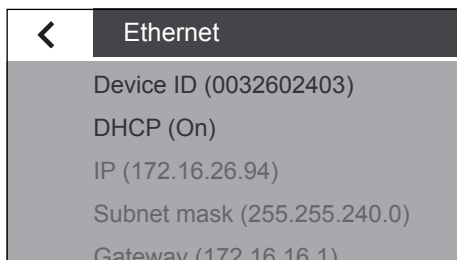

▶ Go into the submenu "DHCP".

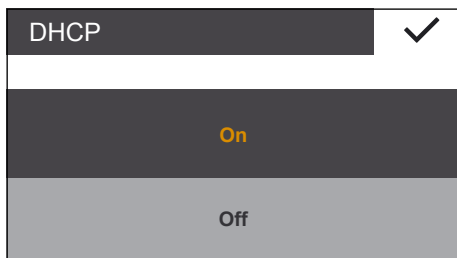

- ▶ Select "Off".
- ▶ Confirm with the ✓ key.
- ▷ The DHCP mode is now turned off.

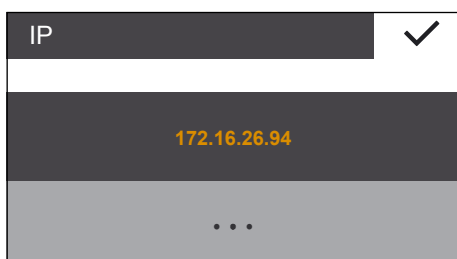

- ▶ Go into the submenu "IP (xxxxxxx)".
- ▶ Select "...".

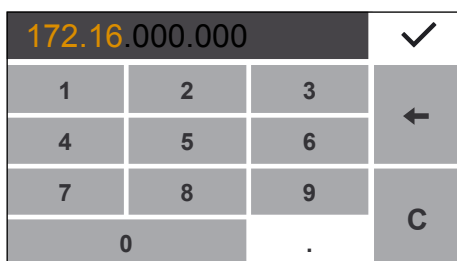

- ▶ Enter a new IP address using the input box.
Make sure:
 - to use an IP address from the same address space as the Windows PC (Subnet Mask).
 - not to use the same IP address as the Windows PC.
- ▶ Confirm the entry with the ✓ button and exit the Settings menu.

The settings may have to be configured in the submenu "Subnet Mask" and "Gateway".

- ▶ Restart the scale.
- ▶ Check the network connection (see Chapter 9.3, page 44).

9.3 Testing the Network Connection

The IP address and device ID can always be found in the submenu "Device Information".

- ▶ Press the ⚙ button to call up the "Settings" menu.
- ▶ Go into the submenu "Device Information".

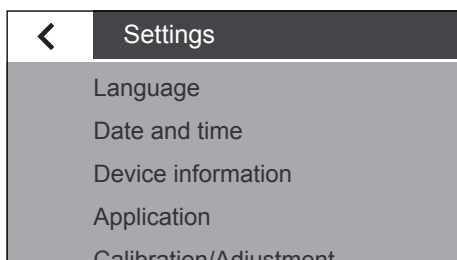

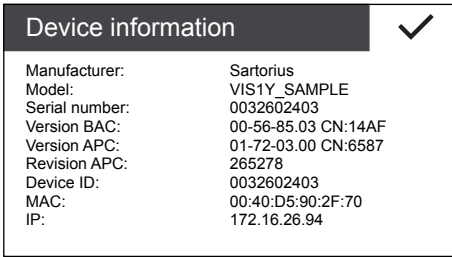

▶ The submenu "Device Information" is displayed.

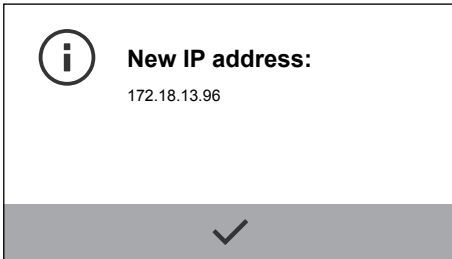

If the IP address of the scale changes, e.g. after the DHCP server allocates a new address, an info message notifies the user of the change.

▶ Confirm this message with the ✓ key.

9.3.1 "Ping" Command

To check whether the network connection is working properly, send a "ping" to the scale.

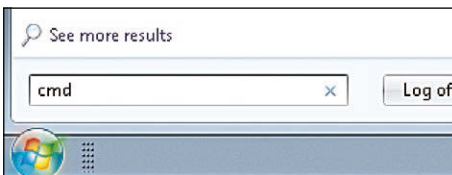

▶ In the input area of the start menu, enter the command "cmd".

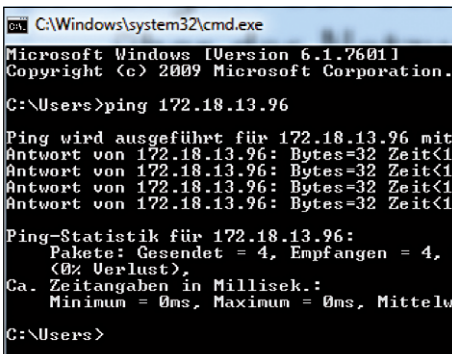

- ▶ Enter the command "ping" in the Windows command console followed by a space and the IP address of the scale.
- ▶ Confirm the entry with [Enter].
- ▶ The adjacent figure illustrates what successful detection of the scale looks like.
- ▶ If the network connection does not work, contact your administrator.

9.3.2 Access via UPnP (Universal Plug and Play)

The UPnP protocol allows you to find the scale without knowing its IP address on the network.

The following requirements must be fulfilled:

- Windows PC (XP SP2 and higher) with unlocked UPnP on the same network.
(To activate UPnP, see the documentation for the installed operating system.)
- Support and activation of the UPnP Protocol in the router.

► Open the network devices page in the "Explorer".



In addition to other UPnP devices, all of the PMA.Vision scales located on the network are listed under "Other Devices":

► Call up the properties of PMA.Vision "PAINT" by clicking with the right mouse button.

The device side of the scale can be called up directly in the web browser by double-clicking on [PMA.Vision "PAINT"].

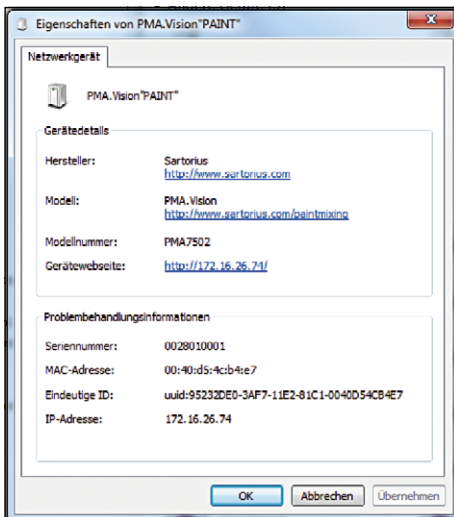

All of the important information about the scale is shown in the properties window.

9.3.3 Web Browser Access

When the network connection is properly configured, the scale can be accessed using a Web browser from any device on the network. The IP address or the name of the scale is needed for this.

Enter one of the following addresses in the address bar of the Web browser:

- <http://172.18.13.96/index.htm>
- <http://PAINT/index.htm>

9.4 Changing the Device Name of the Scale

The scale appears on the network with a device name (device ID). The device ID is the serial number by default. Follow these steps to change the device ID:

- ▶ Press the "i" button to call up the "Settings" menu.
- ▶ Go into the submenu "Ethernet".

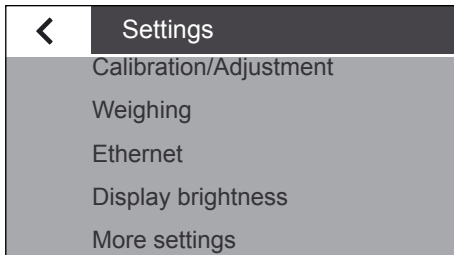

- ▶ Go into the submenu "Device ID".

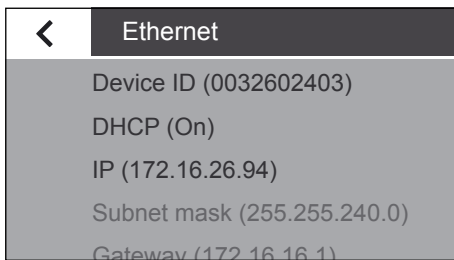

- ▶ Select "... " to enter a new device ID.

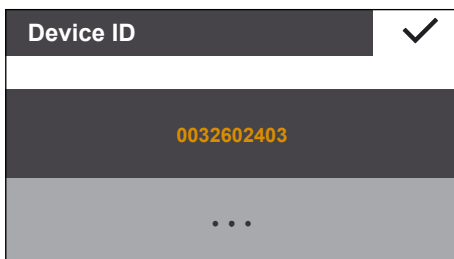

- ▶ Enter a new device ID in the displayed input field. Only letters, numbers and hyphens may be used.
- ▶ Confirm with the ✓ key.

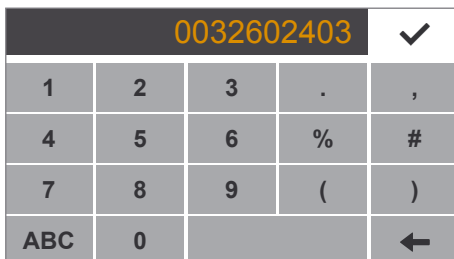

10 Cleaning and Maintenance

10.1 Cleaning

Before cleaning the power supply, ex-link converter, or the scale: Disconnect all devices from the power supply.

WARNING Electrical Hazard from Voltage or Current

Disconnect the power supply (if connected) from the mains. Unplug any connected data cables from the ex-link converter. Never open the scale or the power supply. The parts contained in these cannot be cleaned, repaired or replaced by the operator.

NOTICE

Do not clean the following parts with acetone or aggressive cleaning agents:

- Mains socket
 - Data interface
 - Labels, and all other plastic parts
-

Procedure

- ▶ Disconnect the device from the power supply.
- ▶ **NOTICE** Make sure that no liquid or dust gets into the scale or the power supply.
- ▶ **NOTICE** Corrosion or damage to the device due to unsuitable cleaning agents!
 - ▶ **Do not** use corrosive, chloride-containing and aggressive cleaning agents.
 - ▶ **Do not** use cleaning agents that contain abrasive ingredients, e.g. scouring agents, steel wool.
 - ▶ Only use soft brushes and cloths for cleaning.
 - ▶ **Do not** use solvent-based cleaning agents.

Cleaning the Control Panel

- ▶ Before cleaning the control panel: Turn off the device as touching the screen could trigger unwanted inputs.

Cleaning the Device Housing

- ▶ Wipe off the housing with a slightly damp cloth. In the event of more severe contamination, use a mild soap solution.
- ▶ Wipe the device with a soft cloth.

10.2 Servicing

To ensure the continued accuracy of your scale, we recommend scheduling regular servicing at least once a year. Sartorius Service offers different service contracts with maintenance intervals that are tailored to your needs.

A calibration certificate should always be issued as part of every maintenance session. Safety inspections of the power supply and its connections must be performed at appropriate intervals by a qualified electrician (e.g. every two years).

11 Faults

Messages appear on the display when certain events occur:

- Info messages are displayed for two seconds. The program then returns automatically to its original state.
- Error messages are displayed until they are acknowledged with the ✓ key.

Application Error Messages

Error Message	Cause
Value is too small.	When an entered value is too low for the parameter.
Value is too large.	When an entered value is too high for the parameter.
Wrong password.	When password protection is enabled and the code was entered incorrectly.
Wrong license code.	If the service license code was entered incorrectly.

Calibration/Adjustment Error Messages

Error Message	Cause
The weight is too light.	A weight that is too light was placed on the scale during external calibration.
The weight is too heavy.	A weight that is too heavy was placed on the scale during external calibration.

Calibration Report Error Messages

Error Message	Cause
Not able to save cal. data	The limit of 99 data records per day has been reached.
Unable to read file	An error occurred when reading the file.

Scale Maintenance Error Messages

Error Message	Cause
Maintenance interval exceeded.	When the maintenance date set by Service has passed.
The date and time setting is incorrect.	Date has been set in the past or clock battery is empty.

12 Storage and Shipping

12.1 Storage

Procedure

- ▶ If the device is in operation:
 - ▶ Decommission the device.
 - ▶ Clean the device.
- ▶ Store the device according to the ambient conditions (see Chapter "15 Technical Data", page 53).

12.2 Shipping-related Tasks/Returns

You can send defective devices or parts back to Sartorius. Returned devices must be clean, decontaminated, and packed in their original packaging.

Transport damage as well as measures for subsequent cleaning and disinfection of the device or parts by Sartorius shall be charged to sender.

WARNING

Risk of injury due to contaminated equipment!

Devices contaminated with hazardous materials (NBC contamination) will **not** be accepted for repair or disposal.

- ▶ Observe the Information on Decontamination (see Chapter 13.1, page 51).
-

Procedure

- ▶ Decommission the device.
- ▶ Fill out the Decontamination Declaration. Use the forms available on our website (www.sartorius.com).
- ▶ Enclose the Decontamination Declaration with the delivery documents. The recipient must be able to inspect the completed Decontamination Declaration before removing the device from the packaging.
- ▶ Pack the device and its parts in their original packaging.
- ▶ Return the device to Sartorius Service. The service addresses for returns can be found on our website (www.sartorius.com).

13 Disposal

13.1 Information on Decontamination

According to the EU directives [European directive on hazardous substances], the owners of devices that come into contact with hazardous substances are responsible for properly disposing of these devices and for declaring such devices when transporting them.

WARNING

Risk of injury due to contaminated equipment!

Devices contaminated with hazardous materials (NBC contamination) will not be accepted for repair or disposal.

13.2 Disposing of Device and Parts

13.2.1 Information on Disposal

The device and the accessories **do not** belong in your regular household waste, since they are made of high-grade materials which can be recycled and reused. All parts must be disposed of properly by disposal facilities.

The packaging is made of environmentally friendly materials that can be used as secondary raw materials.

13.2.2 Disposal

Requirements

The device has been decontaminated.

Procedure

- ▶ Dispose of the device. Follow the disposal instructions on our website (www.sartorius.com).
- ▶ Dispose of the packaging in accordance with local government regulations.

14 Serial Number Coding



The manufacture date of this device is encoded in the serial number. The format is as follows:

YMM x x x x

Y	Year
3	2014–2020
4	2021–2027
5	2028–2034, etc.

The Y column indicates the year group, which covers a period of 7 years. Within each year group, the months (M M) are counted up from 13.

Year:	2015	2016	2017	2018	2019	...
MM:	25–36	37–48	49–60	61–72	73–84	...

Example:

328xxxx (April 2015). "xxxxx" is a consecutive number. Every month it starts with 1 and increases consecutively.

15 Technical Data

15.1 General Data

Specification	Unit	Value
Scale		
Supply voltage		Only via Sartorius power supply YEPS01-USB
Input voltage	V_{DC}	+5.0
Power consumption	W	5.1
Further data		IP40 in accordance with EN 60529/IEC 60529
Ambient conditions		
The specifications apply under the following ambient conditions:		
Environment		For indoor use only.
Operational capability	°C	Guaranteed between +5 and +40.
Storage and shipping	°C	-10 to +60
Relative humidity	%	Up to 80% for temperatures up to 30°C non-condensing, decreasing linearly up to 50% relative humidity at 40°C.
Ex-link converter interface connection		Ethernet
Electromagnetic Compatibility		In accordance with EN 61326-1/IEC61326-1 Electrical equipment for measurement, control and laboratory use – EMC requirements – Part 1: General Requirements.
Interference resistance		Basic requirements
Transient emissions		Class B Suitable for use in residential areas and areas that are connected to a low voltage network that also supplies residential buildings.
		Verified scales in accordance with EU requirements comply with the requirements of Council Directive 2014/31/EU with EN 45501:2015 and OIML R76:2006.
		* For verified scales in accordance with EU requirements, refer to the information on the scale. ** For verified scales in accordance with EU requirements, the legal regulations apply.
Available application programs		Recalculation, factor calculation, formula
Power supply YEPS01-USB		
USB power plug		Type FSP007-P01P (manufacturer's designation)
Primary		100 – 240 V~, ±10%, 50 – 60 Hz, ±5%, ≤ 0.2 A
Secondary		5.2 V_{DC} ± 5%, 1.4 A (max.)
Further data		Protection class II IP40 in accordance with EN 60529/IEC 60529
Ex-Link Converter YC016-Z		
Further data		IP40 in accordance with EN 60529/IEC 60529

15.2 Model-specific Data

Specification	Unit	Value
Weighing capacity	g	7500 999.95
Readability	g	0.1 0.05
Tare range (subtractive)	g	-7500
External adjustment weight/ accuracy class	kg	1, 2, 5 / F2 or better
Diameter of weighing pan	mm	233
Net weight	kg	2.4

15.3 Verified Models with EC Type Examination Certificate: Model-specific Technical Data

Specification	Unit	Value
Accuracy class		II
Type		PMA-EV
Weighing capacity max.	g	7500
Weighing capacity min.	g	5
Scale interval d	g	0.1
Verification scale interval e	g	1
Number of scale Intervals n		7500
Temperature range	°C	+10 to +30
Tare equalization range (subtractive)		≤ 100% from max. weighing capacity
Nominal load of the load receptor *	g	8000
Switch-on zero setting	g	± 375
Diameter of weighing pan	mm	233

* The sum of the max. switch-on zero setting and dead load may not exceeded the nominal load of the load receptor.

15.4 Device Dimensions

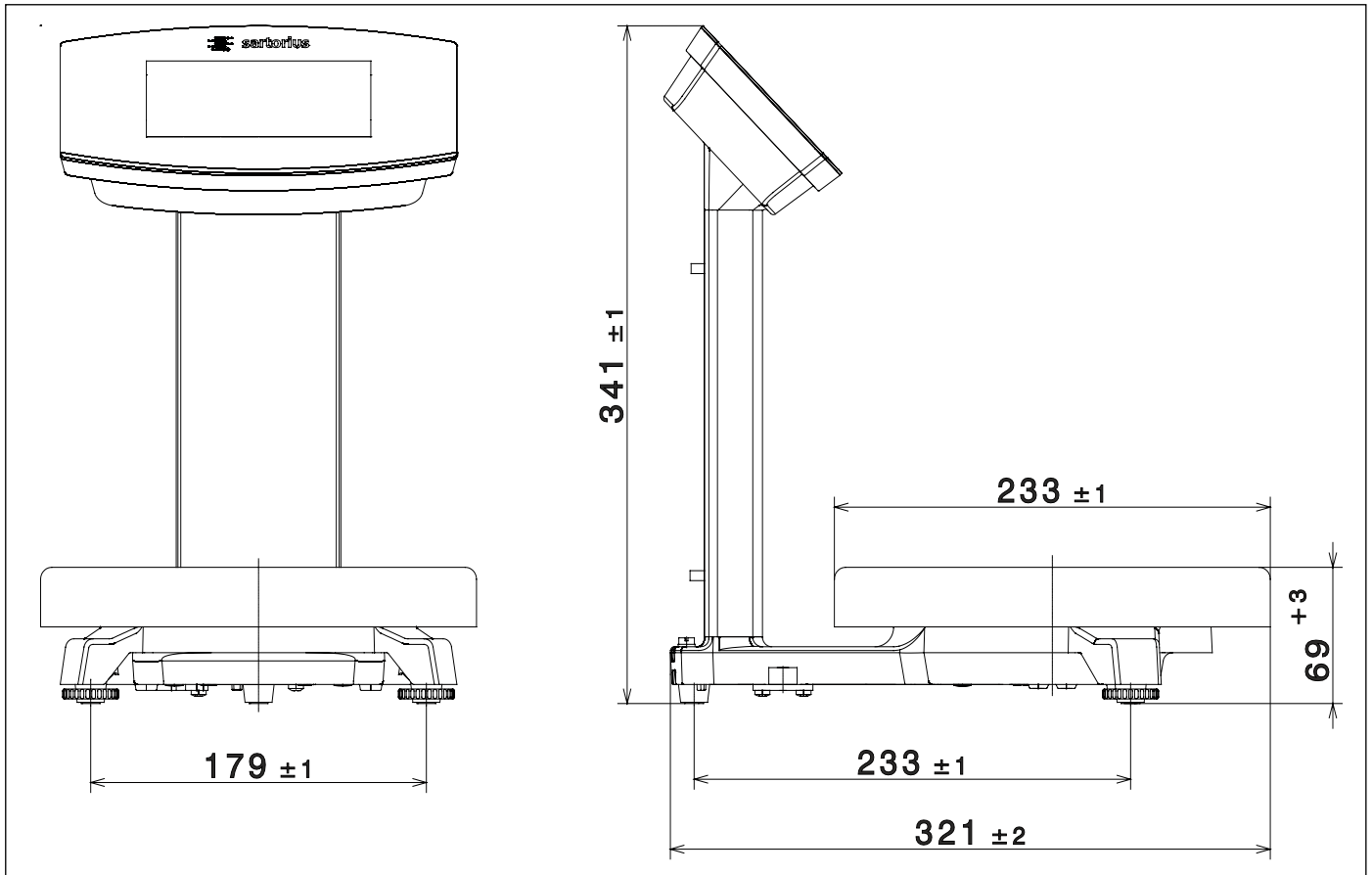

Fig. 1: Device dimensions PMA.Vision VIS1X (information in mm)

16 Accessories

This table contains an excerpt of accessories that can be ordered. For information on other products, contact Sartorius.

Accessories	Order Number
Power supply (5.2 V/1.4 A)	YEPS01-USB
USB cable, 3 m	YCC01-0040M3
Mains adapter set for YEPS01-USB	YEPS01-PS1
– USA and Japan (US+JP)	
– Europe (EU)	
– United Kingdom (GB)	
Mains adapter set for YEPS01-USB	YEPS01-PS6
– Argentina (AR)	
– Brazil (BR)	
– Australia (AU)	
– South Africa (ZA)	
Mains adapter set for YEPS01-USB	YEPS01-PS7
– China (CN)	
– India (IN)	
– Korea (KR)	
Ex-link converter	YCO17-Z
Link cable from converter to scale, 10 m	YCC01-0052M10
Link cable from converter to scale, 20 m	YCC01-0052M20
Link cable from converter to scale, 30 m	YCC01-0052M30
Ethernet patch cable from the converter to the PC, 5 m	YCC01-0044M5
Equipotential bonding cable, 2 m	YCC01-X046M2
In-use cover for control panel, pack of 10	YDC03PMA10
In-use cover for support arm, pack of 10	YDC03PMA-CO10
In-use cover for weighing pan, pack of 10	YDC03PMA-WP10
CAL weight	
– for PMA.Vision, 5 kg, accuracy class F2	YCW654-AC-00
– for PMA.Vision, 2 kg, accuracy class F2	YCW624-AC-00
– for PMA.Vision, 1 kg, accuracy class F2	YCW614-AC-00

17 Sartorius Service

Sartorius Service is at your disposal for queries regarding the device. For information about the service addresses, services provided or to contact a local representative, please visit the Sartorius website (www.sartorius.com).

18 Conformity & Approvals

18.1 EU Declaration of Conformity

The attached Declaration of Conformity hereby confirms compliance of the device with the directives cited. The declaration of conformity supplied here is for conformity-assessed (verified) weighing instruments for use in the EEA. Please keep it in a safe place.



CE EU-Konformitätserklärung EU Declaration of Conformity

Hersteller
Manufacturer Sartorius Lab Instruments GmbH & Co. KG
D-37070 Goettingen, Germany

erklärt in alleiniger Verantwortung, dass das Betriebsmittel
declares under sole responsibility that the equipment

Geräteart
Device type Farbmischwaage / Ex-Link-Box
Paint mixing scale / Ex-link-box

Baureihe
Type series VIS1X... / YCO16-Z

in der von uns in Verkehr gebrachten Ausführung allen einschlägigen Bestimmungen der folgenden Europäischen Richtlinien – einschließlich deren zum Zeitpunkt der Erklärung geltenden Änderungen – entspricht und die anwendbaren Anforderungen folgender harmonisierter Europäischer Normen erfüllt:
in the form as delivered fulfils all the relevant provisions of the following European Directives – including any amendments valid at the time this declaration was signed – and meets the applicable requirements of the harmonized European Standards listed below:

2014/30/EU	Elektromagnetische Verträglichkeit <i>Electromagnetic compatibility</i> EN 61326-1:2013
2011/65/EU	Beschränkung der Verwendung bestimmter gefährlicher Stoffe in Elektro- und Elektronikgeräten (RoHS) <i>Restriction of the use of certain hazardous substances in electrical and electronic equipment (RoHS)</i> EN 50581:2012
2014/34/EU	Geräte und Schutzsysteme zur bestimmungsgemäßen Verwendung in explosionsgefährdeten Bereichen <i>Equipment and protective systems intended for use in potentially explosive atmospheres</i> EN 60079-0:2012, EN 60079-11:2012

Kennzeichnung / <i>Marking</i>	II 2 G Ex ib IIB T4 Gb II (2) G [Ex ib Gb] IIB	für/for VIS1X... für/for YCO16-Z
Zertifizierung <i>Certification</i>	EG-Baumusterprüfbescheinigung Nummer: <i>EC-Type Examination Certificate number:</i>	FM15ATEX0032X für/for VIS1X... FM15ATEX0034X für/for YCO16-Z
Anerkennung der Qualitätssicherung (Produktion) / <i>Quality Assurance Notification (production):</i>		FM13ATEXQ0092

Jahreszahl der CE-Kennzeichenvergabe / *Year of the CE mark assignment:* 16

Sartorius Lab Instruments GmbH & Co. KG
Goettingen, 2016-04-20

Dr. Reinhard Baumfalk
Vice President R&D

Dr. Dieter Klausgrete
Head of International Certification Management

Diese Erklärung bescheinigt die Übereinstimmung mit den genannten EU-Richtlinien, ist jedoch keine Zusicherung von Eigenschaften. Bei einer mit uns nicht abgestimmten Änderung des Produktes verliert diese Erklärung ihre Gültigkeit. Die Sicherheitshinweise der zugehörigen Produktdokumentation sind zu beachten.

This declaration certifies conformity with the above mentioned EU Directives, but does not guarantee product attributes. Unauthorised product modifications make this declaration invalid. The safety information in the associated product documentation must be observed.

Doc: 2035289-01 SLI15CE009-01.de,en 1 / 1 PMF: 2035288 OP-113_fo1_2015.10.12

FCC Supplier's Declaration of Conformity



Device type Paint mixing scale + Ex-link-box

Type series VIS1X... + YC0176-Z

Party issuing Supplier's Declaration of Conformity / Responsible Party – U.S. Contact Information

Sartorius Corporation
5 Orville Dr Suite 200
11716 Bohemia, NY
USA
Telephone: +1.631.254.4249

FCC Compliance Statement

This device complies with Part 15 of the FCC Rules. Operation is subject to the following two conditions: (1) This device may not cause harmful interference, and (2) this device must accept any interference received, including interference that may cause undesired operation.

Information to the user

Note: This equipment has been tested and found to comply with the limits for a **class B** digital device, pursuant to part 15 of the FCC Rules. These limits are designed to provide reasonable protection against harmful interference in a residential installation. This equipment generates, uses and can radiate radio frequency energy and if not installed and used in accordance with the instructions, may cause harmful interference to radio communications. However, there is no guarantee that interference will not occur in a particular installation. If this equipment does cause harmful interference to radio or television reception, which can be determined by turning the equipment off and on, the user is encouraged to try to correct the interference by one or more of the following measures:

- Reorient or relocate the receiving antenna.
- Increase the separation between the equipment and receiver.
- Connect the equipment into an outlet on a circuit different from that to which the receiver is connected.
- Consult the dealer or an experienced radio/TV technician for help.

Connections between the device and peripherals must be made using shielded cables in order to maintain compliance with FCC radio frequency emission limits.

Any modifications made to this device that are not approved by Sartorius may void the authority granted to the user by the FCC to operate this equipment.

18.2 Explosion Protection Approvals

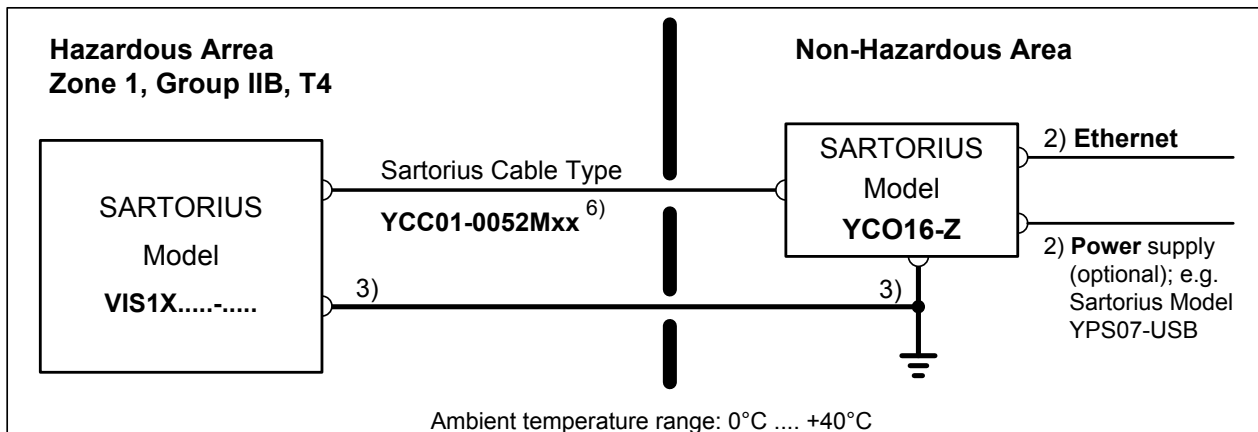

These safety instructions apply to the installation, operation, maintenance and repair of the equipment

- 1) Install the equipment in compliance with applicable laws, rules and regulations, ordinances and standards. For ATEX: In particular, be sure to conform to the European Standards EN 60079-14 (Explosive atmospheres – Part 14: Electrical installations design, selection and erection). Be sure to follow the installation, operating, maintenance and servicing instructions given in the manuals supplied.
- 2) No connection to any device that uses or generates in excess of 250Vrms or 250Vdc.
- 3) All metal parts must be electrically connected to the terminal for the equipotential bonding conductor (PA). The equipment operator is obligated to connect a lead with a gauge of at least 4 mm² (cross section) to the PA terminal located on the housing of the Ex-Link converter and scale. The low resistance of this connection to the PA bus bar must be checked when the system is installed at the intended place of use. The shielding of the connecting cables may only be used for grounding when no impermissible difference in voltage is generated and, if necessary, the shielding is able to conduct the equipotential current.
- 4) Exposure to UV radiation is not allowed!
- 5) The connecting cable of the display unit must be prevented against damage and stress caused by strain.
- 6) Only the Sartorius cable type YCC01-0052Mxx (XX = 10 for 10m, 20 for 20m; 30 for 30m) may be used. Maximum cable length: 100ft (30.5m). The data cable connected to the scale (weighing unit) is considered as intrinsically safe circuit. Check the correct function of the data transfer before you use the equipment in a hazardous location. The equipment operator is responsible for any non-Sartorius cables used.
- 7) Prior to opening the equipment, disconnect the power supply or make sure that there is no potentially explosive atmosphere or any other explosion hazard in the surrounding area!
- 8) If the equipment does not operate properly, unplug it immediately from line power (mains supply)!
- 9) The equipment shall be installed in such a way that it is protected against the entry of solid foreign objects or water capable of impairing the safety of the apparatus. Reduce the risk of mechanical damage to a minimum.
- 10) Avoid generating static electricity. Use only a damp cloth to wipe down the equipment. The equipment operator shall be responsible for preventing any risks caused by static electricity.
- 11) Keep chemicals and other agents, which can corrode the housing seals and cable sheaths, away from the equipment. These agents include oil, grease, benzene, acetone and ozone. If you are not sure about the safety of a certain substance, please contact the manufacturer.
- 12) Use equipment only in the temperature ranges indicated. Avoid exposing the equipment to heat.
- 13) At reasonable intervals, have your equipment installation checked for proper functioning and safety by a trained and certified technician.
- 14) **WARNING: SUBSTITUTION OF COMPONENTS MAY IMPAIR INTRINSIC SAFETY.** If your equipment needs to be repaired, use only original spare parts supplied by the manufacturer!
- 15) Any tampering with the equipment by anyone, other than repair work done by authorized Sartorius service technicians, will result in the loss of EX conformity and in the forfeiture of all claims under the manufacturer's warranty. Only authorized specialists may open the equipment.
- 16) Modifications, including those to be carried out by Sartorius employees, may be permitted only after the express written authorization has been obtained from Sartorius.

	2015-02-20		Safety Instructions	VIS1X.....-..... + YCO16-Z	
	Dr. D. Klausgrete		2003810	Revision 00	Sheet 1 of 1

1 EU-TYPE EXAMINATION CERTIFICATE



2 **Equipment or Protective systems intended for use in Potentially Explosive Atmospheres - Directive 2014/34/EU**

3 **EU-Type Examination Certificate No:** FM15ATEX0032X

4 **Equipment or protective system:** PMA.Vision VIS1X...-... weighing unit
(Type Reference and Name)

5 **Name of Applicant:** Sartorius Lab Instruments GmbH & Co. KG

6 **Address of Applicant:** Otto-Brenner-Straße 20
Goettingen 37079
Germany

7 This equipment or protective system and any acceptable variation thereto is specified in the schedule to this certificate and documents therein referred to.

8 FM Approvals Ltd, notified body number 1725 in accordance with Article 17 of Directive 2014/34/EU of 26 February 2014, certifies that this equipment has been found to comply with the Essential Health and Safety Requirements relating to the design and construction of equipment intended for use in potentially explosive atmospheres given in Annex II to the Directive.

The examination and test results are recorded in confidential report number:

3055566 dated 29th February 2016

9 Compliance with the Essential Health and Safety Requirements, with the exception of those identified in item 15 of the schedule to this certificate, has been assessed by compliance with the following documents:

EN 60079-0:2012 + A11:2013, and EN 60079-11:2012

10 If the sign 'X' is placed after the certificate number, it indicates that the equipment is subject to specific conditions of use specified in the schedule to this certificate.

11 This EU-Type Examination certificate relates only to the design, examination and tests of the specified equipment or protective system in accordance to the directive 2014/34/EU. Further requirements of the Directive apply to the manufacturing process and supply of this equipment or protective system. These are not covered by this certificate.

12 The marking of the equipment or protective system shall include:

 II 2 G Ex ib IIB T4 Gb Ta = 0°C to 40°C



cn=Mick Gower, o=FM Approvals,
ou,
email=mick.gower@fmapprovals.
com, c=GB
2017.11.08 15:56:02 Z

Mick Gower
Certification Manager, FM Approvals Ltd.

Issue date: 08th November 2017

THIS CERTIFICATE MAY ONLY BE REPRODUCED IN ITS ENTIRETY AND WITHOUT CHANGE

FM Approvals Ltd. 1 Windsor Dials, Windsor, Berkshire, UK. SL4 1RS
T: +44 (0) 1753 750 000 F: +44 (0) 1753 868 700 E-mail: atex@fmapprovals.com www.fmapprovals.com

F ATEX 020 (Apr/16)

Page 1 of 3

SCHEDULE

to EU-Type Examination Certificate No. FM15ATEX0032X

13 Description of Equipment or Protective System:

The PMA.Vision VIS1Xab-c is designed for the measurement of weight in the hazardous location. The PMA.Vision contains the processing circuitry and has a touch enable LCD display with backlight facility. Power and data to the non-hazardous location are provided via the YCO16-Z Ex-Link Converter (FM15ATEX0034X). All signal outputs to the Ex-Link Converter are in RS232 communications. The PMA.Vision is housed within non-metallic enclosure. A dedicated potential equalization connection is provided on both the PMA.Vision and the YCO16-Z Ex-Link Converter. Power and data connections between the YCO14-Z and the PMA.Vision are made via a multi-conductor CAT6 cable.

PMA.Vision VIS1Xab-c

a = Accessories: Up to three letters and/or numbers or blank (not critical to safety)

b = Metrology Approval: Up to two letters and/or numbers or blank (not critical to safety)

c = Up to five letters and/or numbers or blank (not critical to safety)

14 Specific Conditions of Use:

1. The PMA.Vision shall only be used with the YCO16-Z Ex-Link Converter (FM15ATEX0034X).
2. The protective ground connectors on the PMA.Vision and the YCO16-Z Ex-Link Converter shall be connected together using a potential equalisation conductor with a cross-sectional area of at least 4 mm².
3. The CAT6 cable used between the PMA.Vision and the YCO16-Z Ex-Link Converter shall be obtained from Sartorius.
4. The enclosure of the PMA.Vision is non-conducting and may generate an ignition-capable level of electrostatic charges under certain extreme conditions. The user shall ensure that the equipment is not installed in a location where it may be subjected to external conditions that might cause a build-up of electrostatic charges on non-conducting surfaces, additionally; cleaning of the equipment should be done only with a damp cloth.

15 Essential Health and Safety Requirements:

The relevant EHSRs that have not been addressed by the standards listed in this certificate have been identified and assessed in the confidential report identified in item 8.

16 Test and Assessment Procedure and Conditions:

This EU-Type Examination Certificate is the result of testing of a sample of the product submitted, in accordance with the provisions of the relevant specific standard(s), and assessment of supporting documentation. It does not imply an assessment of the whole production.

Whilst this certificate may be used in support of a manufacturer's claim for CE Marking, FM Approvals Ltd accepts no responsibility for the compliance of the equipment against all applicable Directives in all applications.

This Certificate has been issued in accordance with FM Approvals Ltd's ATEX Certification Scheme.

17 Schedule Drawings

THIS CERTIFICATE MAY ONLY BE REPRODUCED IN ITS ENTIRETY AND WITHOUT CHANGE

FM Approvals Ltd. 1 Windsor Dials, Windsor, Berkshire, UK. SL4 1RS

T: +44 (0) 1753 750 000 F: +44 (0) 1753 868 700 E-mail: atex@fmapprovals.com www.fmapprovals.com

F ATEX 020 (Apr/16)

Page 2 of 3

SCHEDULE



to EU-Type Examination Certificate No. FM15ATEX0032X

A list of the significant parts of the technical documentation is annexed to this certificate and a copy has been kept by the Notified Body.

18 **Certificate History**

Details of the supplements to this certificate are described below:

Date	Description
09 th March 2016	Original Issue.
08 th November 2017	<u>Supplement 1:</u> Report Reference: – Revision report RR211107 dated 7th November 2017. Description of the Change: Updated labels, minor updates to documentation, minor product updates and convert certificate to new EU format

THIS CERTIFICATE MAY ONLY BE REPRODUCED IN ITS ENTIRETY AND WITHOUT CHANGE

FM Approvals Ltd. 1 Windsor Dials, Windsor, Berkshire, UK. SL4 1RS
 T: +44 (0) 1753 750 000 F: +44 (0) 1753 868 700 E-mail: atex@fmapprovals.com www.fmapprovals.com

F ATEX 020 (Apr/16)

Page 3 of 3

1 EU-TYPE EXAMINATION CERTIFICATE



2 **Equipment or Protective systems intended for use in Potentially Explosive Atmospheres - Directive 2014/34/EU**

3 **EU-Type Examination Certificate No:** FM15ATEX0034X

4 **Equipment or protective system:** YCO16-Z Ex-Link Converter
(Type Reference and Name)

5 **Name of Applicant:** Sartorius Lab Instruments GmbH & Co. KG

6 **Address of Applicant:** Otto-Brenner-Straße 20
Goettingen 37079
Germany

7 This equipment or protective system and any acceptable variation thereto is specified in the schedule to this certificate and documents therein referred to.

8 FM Approvals Ltd, notified body number 1725 in accordance with Article 17 of Directive 2014/34/EU of 26 February 2014, certifies that this equipment has been found to comply with the Essential Health and Safety Requirements relating to the design and construction of equipment intended for use in potentially explosive atmospheres given in Annex II to the Directive.

The examination and test results are recorded in confidential report number:

3055566 dated 29th February 2016

9 Compliance with the Essential Health and Safety Requirements, with the exception of those identified in item 15 of the schedule to this certificate, has been assessed by compliance with the following documents:

EN 60079-0:2012 + A11:2013, and EN 60079-11:2012

10 If the sign 'X' is placed after the certificate number, it indicates that the equipment is subject to specific conditions of use specified in the schedule to this certificate.

11 This EU-Type Examination certificate relates only to the design, examination and tests of the specified equipment or protective system in accordance to the directive 2014/34/EU. Further requirements of the Directive apply to the manufacturing process and supply of this equipment or protective system. These are not covered by this certificate.

12 The marking of the equipment or protective system shall include:



II (2) G [Ex ib Gb] IIB



cn=Mick Gower, o=FM Approvals,
ou,
email=mick.gower@fmaprovals.
com, c=GB
2017.11.08 15:34:05 Z

Mick Gower
Certification Manager, FM Approvals Ltd.

Issue date: 08th November 2017

THIS CERTIFICATE MAY ONLY BE REPRODUCED IN ITS ENTIRETY AND WITHOUT CHANGE

FM Approvals Ltd. 1 Windsor Dials, Windsor, Berkshire, UK. SL4 1RS
T: +44 (0) 1753 750 000 F: +44 (0) 1753 868 700 E-mail: atex@fmaprovals.com www.fmaprovals.com

F ATEX 020 (Apr/16)

Page 1 of 3

SCHEDULE



to EU-Type Examination Certificate No. FM15ATEX0034X

13 **Description of Equipment or Protective System:**

The YCO16-Z Ex-Link Converter is a dedicated device providing power and data to the PMA.Vision VIS1X...-... weighing platforms (FM15ATEX0032X). All signal outputs to the PMA.Vision are available in RS232 communications. The YCO16-Z Ex-Link Converter is housed within non-metallic enclosure. A dedicated potential equalization connection is provided on both the PMA.Vision and the YCO16-Z ExLink Converter. Power and data connections between the YCO16-Z and the PMA.Vision are made via a multi-conductor CAT6 cable.

Electrical ratings
Um = 250 V

14 **Specific Conditions of Use:**

1. The YCO16-Z Ex-Link Converter shall only be used with the PMA.Vision (FM15ATEX0032X).
2. The protective ground connectors on the PMA.Vision and the YCO16-Z Ex-Link Converter shall be connected together using a potential equalisation conductor with a cross-sectional area of at least 4 mm².
3. The CAT6 cable used between the PMA.Vision and the YCO16-Z Ex-Link Converter shall be obtained from Sartorius.

15 **Essential Health and Safety Requirements:**

The relevant EHSRs that have not been addressed by the standards listed in this certificate have been identified and assessed in the confidential report identified in item 8.

16 **Test and Assessment Procedure and Conditions:**

This EU-Type Examination Certificate is the result of testing of a sample of the product submitted, in accordance with the provisions of the relevant specific standard(s), and assessment of supporting documentation. It does not imply an assessment of the whole production.

Whilst this certificate may be used in support of a manufacturer's claim for CE Marking, FM Approvals Ltd accepts no responsibility for the compliance of the equipment against all applicable Directives in all applications.

This Certificate has been issued in accordance with FM Approvals Ltd's ATEX Certification Scheme.

17 **Schedule Drawings**

A list of the significant parts of the technical documentation is annexed to this certificate and a copy has been kept by the Notified Body.

THIS CERTIFICATE MAY ONLY BE REPRODUCED IN ITS ENTIRETY AND WITHOUT CHANGE

FM Approvals Ltd. 1 Windsor Dials, Windsor, Berkshire, UK. SL4 1RS
T: +44 (0) 1753 750 000 F: +44 (0) 1753 868 700 E-mail: atex@fmapprovals.com www.fmapprovals.com

F ATEX 020 (Apr/16)

Page 2 of 3

SCHEDULE

to EU-Type Examination Certificate No. FM15ATEX0034X

18 Certificate History

Details of the supplements to this certificate are described below:

Date	Description
09 th March 2016	Original Issue.
08 th November 2017	<u>Supplement 1:</u> Report Reference: – Revision report RR211107 dated 7th November 2017. Description of the Change: Updated labels, minor updates to documentation, minor product updates and convert certificate to new EU format

THIS CERTIFICATE MAY ONLY BE REPRODUCED IN ITS ENTIRETY AND WITHOUT CHANGE



FM Approvals Ltd. 1 Windsor Dials, Windsor, Berkshire, UK. SL4 1RS
 T: +44 (0) 1753 750 000 F: +44 (0) 1753 868 700 E-mail: atex@fmapprovals.com www.fmapprovals.com

F ATEX 020 (Apr/16)

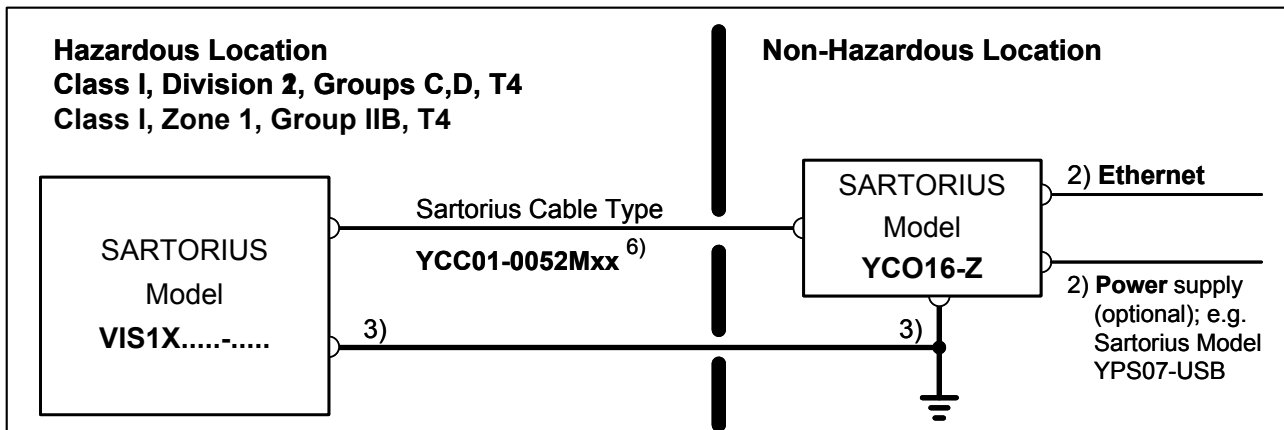
Page 3 of 3



- 1) USA: The installation must be in accordance with the National Electrical Code[®], NFPA 70, Article 504 or 505 and ANSI / ISA-RP 12.6.
Canada: The installation must be in accordance with the Canadian Electrical Code[®], Section 18.
- 2) No connection to any device that uses or generates in excess of 250Vrms or 250Vdc.
- 3) USA: The apparatus must be connected to a suitable ground electrode per National Electrical Code[®], NFPA 70, Article 504 or 505. The resistance of the ground pad must be less than 1 ohm.
Canada: The apparatus must be connected to a suitable ground electrode per Canadian Electrical Code[®], Section 18. The resistance of the ground pad must be less than 1 ohm.
- 4) Ambient temperature range: 0°C +40°C (+32°F + 104°F)
- 5) **WARNING: SUBSTITUTION OF COMPONENTS MAY IMPAIR INTRINSIC SAFETY.**
If your equipment needs to be repaired, use only original spare parts supplied by the manufacturer!
- 6) Only the Sartorius cable type YCC01-0052Mxx (XX = 10 for 10m; 20 for 20m; 30 for 30m) may be used. Maximum cable length: 100ft (30.5m). The equipment operator is responsible for any non-Sartorius cables used.
- 7) Be sure to follow the installation, operating, maintenance and servicing instructions given in the manuals supplied.
- 8) The equipment shall be installed in such a way that it is protected against the entry of solid foreign objects or water capable of impairing the safety of the apparatus. Reduce the risk of mechanical damage to a minimum.
- 9) Exposure to UV radiation is not allowed!
- 10) The connecting cable of the display unit must be prevented against damage and stress caused by strain.
- 11) Prior to opening the equipment, disconnect the power supply or make sure that there is no potentially explosive atmosphere or any other explosion hazard in the surrounding area!
- 12) The data cable connected to the scale (weighing unit) is considered as intrinsically safe circuit. Check the correct function of the data transfer before you use the equipment in a hazardous location.
- 13) If the equipment does not operate properly, unplug it immediately from line power (mains supply)!
- 14) Avoid generating static electricity. Use only a damp cloth to wipe down the equipment. The equipment operator shall be responsible for preventing any risks caused by static electricity.
- 15) Keep chemicals and other agents, which can corrode the housing seals and cable sheaths, away from the equipment. These agents include oil, grease, benzene, acetone and ozone. If you are not sure about the safety of a certain substance, please contact the manufacturer.
- 16) Use equipment only in the temperature ranges indicated. Avoid exposing the equipment to heat.
- 17) At reasonable intervals, have your equipment installation checked for proper functioning and safety by a trained and certified technician.
- 18) Any tampering with the equipment by anyone, other than repair work done by authorized Sartorius service technicians, will result in the loss of EX conformity and in the forfeiture of all claims under the manufacturer's warranty. Only authorized specialists may open the equipment.
- 19) Modifications, including those to be carried out by Sartorius employees, may be permitted only after the express written authorization has been obtained from Sartorius.

	2015-02-20	 sartorius	Control Drawing	VIS1X.....-..... + YCO16-Z	
	Dr. D. Klausgrete		2003809	Revision 00	Sheet 1 of 1



FM Approvals
 1151 Boston Providence Turnpike
 P.O. Box 9102 Norwood, MA 02062 USA
 T: 781 762 4300 F: 781-762-9375 www.fmapprovals.com

CERTIFICATE OF COMPLIANCE

HAZARDOUS (CLASSIFIED) LOCATION ELECTRICAL EQUIPMENT

This certificate is issued for the following equipment:

PMA.Vision VIS1Xab-c

IS / I / 1 / CD / T4 - 2003809

I / 1 / Ex ia / IIB / T4 - 2003809

- a = Accessories: Up to three letters and/or numbers or blank (not critical to safety)
 b = Metrology Approval: Up to two letters and/or numbers or blank (not critical to safety)
 c = Up to five letters and/or numbers or blank (not critical to safety)

Specific conditions of use

1. The PMA.Vision shall only be used with the YCO16-Z Ex-Link Converter.
2. The protective ground connectors on the PMA.Vision and the YCO16-Z Ex-Link Converter shall be connected together using a potential equalization conductor with a cross-sectional area of at least 4 mm².
3. The CAT6 cable used between the PMA.Vision and the YCO16-Z Ex-Link Converter shall be obtained from Sartorius.
4. The enclosure of the PMA.Vision is non-conducting and may generate an ignition-capable level of electrostatic charges under certain extreme conditions. The user shall ensure that the equipment is not installed in a location where it may be subjected to external conditions that might cause a build-up of electrostatic charges on non-conducting surfaces, additionally; cleaning of the equipment should be done only with a damp cloth.

PMA.Vision VIS1Yab-c

NI / I / 2 / CD / T4 – NIFW; 2003809

- a = Accessories: Up to three letters and/or numbers or blank (not critical to safety)
 b = Metrology Approval: Up to two letters and/or numbers or blank (not critical to safety)
 c = Up to five letters and/or numbers or blank (not critical to safety)

Specific conditions of use

1. The PMA.Vision shall only be used with the YCO16-Z Ex-Link Converter.
2. The protective ground connectors on the PMA.Vision and the YCO16-Z Ex-Link Converter shall be connected together using a potential equalization conductor with a cross-sectional area of at least 4 mm².
3. The CAT6 cable used between the PMA.Vision and the YCO16-Z Ex-Link Converter shall be obtained from Sartorius.
4. The enclosure of the PMA.Vision is non-conducting and may generate an ignition-capable level of electrostatic charges under certain extreme conditions. The user shall ensure that the equipment is not installed in a location where it may be subjected to external conditions that might cause a build-up of electrostatic charges on non-conducting surfaces, additionally; cleaning of the equipment should be done only with a damp cloth.

YCO16-Z Ex Link Converter

AIS / I / 1 / CD – 2003809

To verify the availability of the Approved product, please refer to www.approvalguide.com

FM Approvals HLC 5/13

3055566

Page 1 of 3



[I/1] AEx [ib] / IIB - 2003809

Specific conditions of use

1. The YCO16-Z Ex-Link Converter shall only be used with the PMA.Vision VIS1X...-....
2. The protective ground connectors on the PMA.Vision VIS1X...-.... and the YCO16-Z Ex-Link Converter shall be connected together using a potential equalization conductor with a cross-sectional area of at least 4 mm².
3. The CAT6 cable used between the PMA.Vision VIS1X...-.... and the YCO16-Z Ex-Link Converter shall be obtained from Sartorius.

YCO17-Z Ex Link Converter

ANI / I / 1 / CD – 2003809

Specific conditions of use

1. The YCO16-Z Ex-Link Converter shall only be used with the PMA.Vision VIS1Y...-....
2. The protective ground connectors on the PMA.Vision VIS1Y...-.... and the YCO16-Z Ex-Link Converter shall be connected together using a potential equalization conductor with a cross-sectional area of at least 4 mm².
3. The CAT6 cable used between the PMA.Vision VIS1Y...-.... and the YCO16-Z Ex-Link Converter shall be

Equipment Ratings:

PMA.Vision VIS1X...-....

Intrinsically Safe for Class I, Division 1, Groups C, and D, hazardous (classified) locations in accordance with drawing 2003809; and Intrinsically Safe for Class I, Zone 1, Group IIB hazardous (classified) locations in accordance with drawing 2003809.

PMA.Vision VIS1Y...-....

Nonincendive for Class I, Division 2, Groups C, and D, hazardous (classified) locations in accordance with drawing 2003809; and Intrinsically Safe for Class I, Zone 1, Group IIB hazardous (classified) locations in accordance with drawing 2028219.

YCO16-Z Ex-Link Converter

Associated intrinsically safe apparatus for connection to Class I, Division 1 Groups C and D hazardous (classified) locations in accordance with drawing 2003809 and Class I Zone 1 Group IIB hazardous (classified) locations in accordance with drawing 2003809.

YCO17-Z Ex-Link Converter

Associated nonincendive field wiring equipment for connection to Class I, Division 2, Groups C and D hazardous (classified) locations in accordance with drawing 2028219.

FM Approved for:

Sartorius Lab Instruments GmbH & Co KG
Gottingen, Germany

To verify the availability of the Approved product, please refer to www.approvalguide.com
FM Approvals HLC 5/13 3055566



This certifies that the equipment described has been found to comply with the following Approval Standards and other documents:

FM Class 3600	2011
FM Class 3610	2010
FM Class 3611	2004
FM Class 3810	2005
ANSI/ISA 60079-0	2013
ANSI/ISA 60079-11	2014

Original Project ID: 0003055566

Approval Granted: February 29, 2016

Subsequent Revision Reports / Date Approval Amended

Report Number	Date	Report Number	Date
---------------	------	---------------	------

FM Approvals LLC

J.E. Marquedant

J.E. Marquedant
 Manager of Electrical Systems

29 February 2016

Date

To verify the availability of the Approved product, please refer to www.approvalguide.com
 FM Approvals HLC 5/13 3055566



FM Approvals
 1151 Boston Providence Turnpike
 P.O. Box 9102 Norwood, MA 02062 USA
 T: 781 762 4300 F: 781-762-9375 www.fmapprovals.com

CERTIFICATE OF COMPLIANCE

HAZARDOUS LOCATION ELECTRICAL EQUIPMENT PER CANADIAN REQUIREMENTS

This certificate is issued for the following equipment:

PMA.Vision VIS1Xab-c

IS / I / 1 / CD / T4 - 2003809
 I / 1 / Ex ia / IIB / T4 - 2003809

- a = Accessories: Up to three letters and/or numbers or blank (not critical to safety)
 b = Metrology Approval: Up to two letters and/or numbers or blank (not critical to safety)
 c = Up to five letters and/or numbers or blank (not critical to safety)

Specific conditions of use

1. The PMA.Vision shall only be used with the YCO16-Z Ex-Link Converter.
2. The protective ground connectors on the PMA.Vision and the YCO16-Z Ex-Link Converter shall be connected together using a potential equalization conductor with a cross-sectional area of at least 4 mm².
3. The CAT6 cable used between the PMA.Vision and the YCO16-Z Ex-Link Converter shall be obtained from Sartorius.
4. The enclosure of the PMA.Vision is non-conducting and may generate an ignition-capable level of electrostatic charges under certain extreme conditions. The user shall ensure that the equipment is not installed in a location where it may be subjected to external conditions that might cause a build-up of electrostatic charges on non-conducting surfaces, additionally; cleaning of the equipment should be done only with a damp cloth.

PMA.Vision VIS1Yab-c

NI / I / 2 / CD / T4 – NIFW; 2003809

- a = Accessories: Up to three letters and/or numbers or blank (not critical to safety)
 b = Metrology Approval: Up to two letters and/or numbers or blank (not critical to safety)
 c = Up to five letters and/or numbers or blank (not critical to safety)

Specific conditions of use

1. The PMA.Vision shall only be used with the YCO16-Z Ex-Link Converter.
2. The protective ground connectors on the PMA.Vision and the YCO16-Z Ex-Link Converter shall be connected together using a potential equalization conductor with a cross-sectional area of at least 4 mm².
3. The CAT6 cable used between the PMA.Vision and the YCO16-Z Ex-Link Converter shall be obtained from Sartorius.
4. The enclosure of the PMA.Vision is non-conducting and may generate an ignition-capable level of electrostatic charges under certain extreme conditions. The user shall ensure that the equipment is not installed in a location where it may be subjected to external conditions that might cause a build-up of electrostatic charges on non-conducting surfaces, additionally; cleaning of the equipment should be done only with a damp cloth.

YCO16-Z Ex Link Converter

AIS / I / 1 / CD – 2003809

To verify the availability of the Approved product, please refer to www.approvalguide.com



[I/1] Ex [ib] / IIB - 2003809

Specific conditions of use

1. The YCO16-Z Ex-Link Converter shall only be used with the PMA.Vision VIS1X...-....
2. The protective ground connectors on the PMA.Vision VIS1X...-.... and the YCO16-Z Ex-Link Converter shall be connected together using a potential equalization conductor with a cross-sectional area of at least 4 mm².
3. The CAT6 cable used between the PMA.Vision VIS1X...-.... and the YCO16-Z Ex-Link Converter shall be obtained from Sartorius.

YCO17-Z Ex Link Converter

ANI / I / 1 / CD – 2003809

Specific conditions of use

1. The YCO16-Z Ex-Link Converter shall only be used with the PMA.Vision VIS1Y...-....
2. The protective ground connectors on the PMA.Vision VIS1Y...-.... and the YCO16-Z Ex-Link Converter shall be connected together using a potential equalization conductor with a cross-sectional area of at least 4 mm².
3. The CAT6 cable used between the PMA.Vision VIS1Y...-.... and the YCO16-Z Ex-Link Converter shall be

Equipment Ratings:

PMA.Vision VIS1X...-....

Intrinsically Safe for Class I, Division 1, Groups C, and D, hazardous (classified) locations in accordance with drawing 2003809; and Intrinsically Safe for Class I, Zone 1, Group IIB hazardous (classified) locations in accordance with drawing 2003809.

PMA.Vision VIS1Y...-....

Nonincendive for Class I, Division 2, Groups C, and D, hazardous (classified) locations in accordance with drawing 2003809; and Intrinsically Safe for Class I, Zone 1, Group IIB hazardous (classified) locations in accordance with drawing 2028219.

YCO16-Z Ex-Link Converter

Associated intrinsically safe apparatus for connection to Class I, Division 1 Groups C and D hazardous (classified) locations in accordance with drawing 2003809 and Class I Zone 1 Group IIB hazardous (classified) locations in accordance with drawing 2003809.

YCO17-Z Ex-Link Converter

Associated nonincendive field wiring equipment for connection to Class I, Division 2, Groups C and D hazardous (classified) locations in accordance with drawing 2028219.

FM Approved for:

Sartorius Lab Instruments GmbH & Co KG
Gottingen, Germany

To verify the availability of the Approved product, please refer to www.approvalguide.com
FM Approvals HLC 5/13 3055566C



This certifies that the equipment described has been found to comply with the following Approval Standards and other documents:

CSA C22.2 No. 0.4	2013
CSA C22.2 No. 157	1992 (R2012)
CSA C22.2 No. 213	1987 (R2013)
CAN/CSA-C22.2 No. 60079-0	2011
CAN/CSA-C22.2 No. 60079-11	2014
CAN/CSA C22.2 No. 61010-1	2004

Original Project ID: 0003055566

Approval Granted: February 29, 2016

Subsequent Revision Reports / Date Approval Amended

Report Number	Date	Report Number	Date
---------------	------	---------------	------

FM Approvals LLC

J.E. Marquedant
Manager of Electrical Systems

29 February 2016

Date

To verify the availability of the Approved product, please refer to www.approvalguide.com

FM Approvals HLC 5/13

3055566C
Page 3 of 3



IECEX Certificate of Conformity

INTERNATIONAL ELECTROTECHNICAL COMMISSION IEC Certification Scheme for Explosive Atmospheres

for rules and details of the IECEx Scheme visit www.iecex.com

Certificate No.:	IECEX FME 15.0007X	Issue No: 0	<u>Certificate history:</u> Issue No. 0 (2016-03-09)
Status:	Current	Page 1 of 3	
Date of Issue:	2016-03-09		
Applicant:	Sartorius Lab Instruments GmbH & Co. KG Weender Landstrasse 94 - 108 Goettingen 37075 Germany		
Electrical Apparatus:	PMA.Vision VIS1X... & YCO16-Z Link Converter		
Optional accessory:			
Type of Protection:	Intrinsic Safety		
Marking:	Ex ib IIB T4 Gb [Ex ib Gb] IIB 0°C < Ta < 40°C		

Approved for issue on behalf of the IECEx
Certification Body:

Mick Gower

Position:

Certification Manager

Signature:
(for printed version)

Date:

1. This certificate and schedule may only be reproduced in full.
2. This certificate is not transferable and remains the property of the issuing body.
3. The Status and authenticity of this certificate may be verified by visiting the [Official IECEx Website](#).

Certificate issued by:

FM Approvals Ltd
1 Windsor Dials
SL4 1RS Windsor
United Kingdom



Member of the FM Global Group



IECEX Certificate of Conformity

Certificate No: IECEx FME 15.0007X Issue No: 0

Date of Issue: 2016-03-09 Page 2 of 3

Manufacturer: **Sartorius Lab Instruments GmbH & Co. KG**
Weender Landstrasse 94 - 108
Goettingen 37075
Germany

Additional Manufacturing
location(s):

This certificate is issued as verification that a sample(s), representative of production, was assessed and tested and found to comply with the IEC Standard list below and that the manufacturer's quality system, relating to the Ex products covered by this certificate, was assessed and found to comply with the IECEx Quality system requirements. This certificate is granted subject to the conditions as set out in IECEx Scheme Rules, IECEx 02 and Operational Documents as amended.

STANDARDS:

The electrical apparatus and any acceptable variations to it specified in the schedule of this certificate and the identified documents, was found to comply with the following standards:

IEC 60079-0 : 2011 Explosive atmospheres - Part 0: General requirements
Edition:6.0

IEC 60079-11 : 2011 Explosive atmospheres - Part 11: Equipment protection by intrinsic safety "i"
Edition:6.0

*This Certificate **does not** indicate compliance with electrical safety and performance requirements other than those expressly included in the Standards listed above.*

TEST & ASSESSMENT REPORTS:

A sample(s) of the equipment listed has successfully met the examination and test requirements as recorded in

Test Report:

[GB/FME/ExTR16.0001/00](#)

Quality Assessment Report:

[GB/FME/QAR13.0002/01](#)



IECEx Certificate of Conformity

Certificate No: IECEx FME 15.0007X

Issue No: 0

Date of Issue: 2016-03-09

Page 3 of 3

Schedule

EQUIPMENT:

Equipment and systems covered by this certificate are as follows:

The PMA.Vision VIS1Xab-c is designed for the measurement of weight in the hazardous location. The PMA.Vision contains the processing circuitry and has a touch enable LCD display with backlight facility. Power and data to the non-hazardous location are provided via the YCO16-Z Ex-Link Converter. All signal outputs to the Ex-Link Converter are in RS232 communications. The PMA.Vision is housed within non-metallic enclosure. A dedicated potential equalization connection is provided on both the PMA.Vision and the YCO16-Z Ex-Link Converter. Power and data connections between the YCO14-Z and the PMA.Vision are made via a multi-conductor CAT6 cable.

PMA.Vision VIS1Xab-c

a = Accessories: Up to three letters and/or numbers or blank (not critical to safety)

b = Metrology Approval: Up to two letters and/or numbers or blank (not critical to safety)

c = Up to five letters and/or numbers or blank (not critical to safety)

The **YCO16-Z Ex-Link Converter** is a dedicated device providing power and data to the PMA.Vision VIS1X...-... weighing platforms. The YCO16-Z Ex-Link Converter is housed within non-metallic enclosure.

Electrical ratings

Um = 250 V

CONDITIONS OF CERTIFICATION: YES as shown below:

1. The PMA.Vision shall only be used with the YCO16-Z Ex-Link Converter.
2. The protective ground connectors on the PMA.Vision and the YCO16-Z Ex-Link Converter shall be connected together using a potential equalisation conductor with a cross-sectional area of at least 4 mm².
3. The CAT6 cable used between the PMA.Vision and the YCO16-Z Ex-Link Converter shall be obtained from Sartorius.
4. The enclosure of the PMA.Vision is non-conducting and may generate an ignition-capable level of electrostatic charges under certain extreme conditions. The user shall ensure that the equipment is not installed in a location where it may be subjected to external conditions that might cause a build-up of electrostatic charges on non-conducting surfaces, additionally; cleaning of the equipment should be done only with a damp cloth.

18.3 EU Type Examination Certificate (Verified Models)



UK 3066

V(0)a

EU-type examination certificate UK 3066

Issued by:

NMO**Notified Body Number 0126**

In accordance with the requirements of Council Directive 2014/31/EU, this EU-type examination certificate has been issued to:

Sartorius Lab Instruments GmbH & Co KG
37070 Goettingen
Germany

In respect of a family of non-automatic weighing instruments designated the PMA and having the following characteristics:

Type	PMA-EV	PMA-HD
Class	II	III
Max	7500 g	2200 g
Min	5 g	20 g
e =	1 g	1 g
d =	0.1 g	1 g

The necessary data (principal characteristics, alterations, securing, functioning etc) for identification purposes and conditions (when applicable) are set out in the descriptive annex to this certificate.

Issue Date: 8 December 2016
Valid Until: 7 December 2026

Marek Bokota
Technical Manager
For and on behalf of the Head of Certification Body



0135

NMO | Stanton Avenue | Teddington | TW11 0JZ | United Kingdom
 Tel +44 (0) 20 8943 7272 | Fax +44 (0) 20 8943 7270 | Web www.gov.uk/government/organisations/regulatory-delivery
 NMO is part of the Regulatory Delivery directorate within the Department for Business, Energy & Industrial Strategy

Schilder und Marken / Plates and Markings / Plaques et marques / Placas y Marcas / Etichette e Sigilli

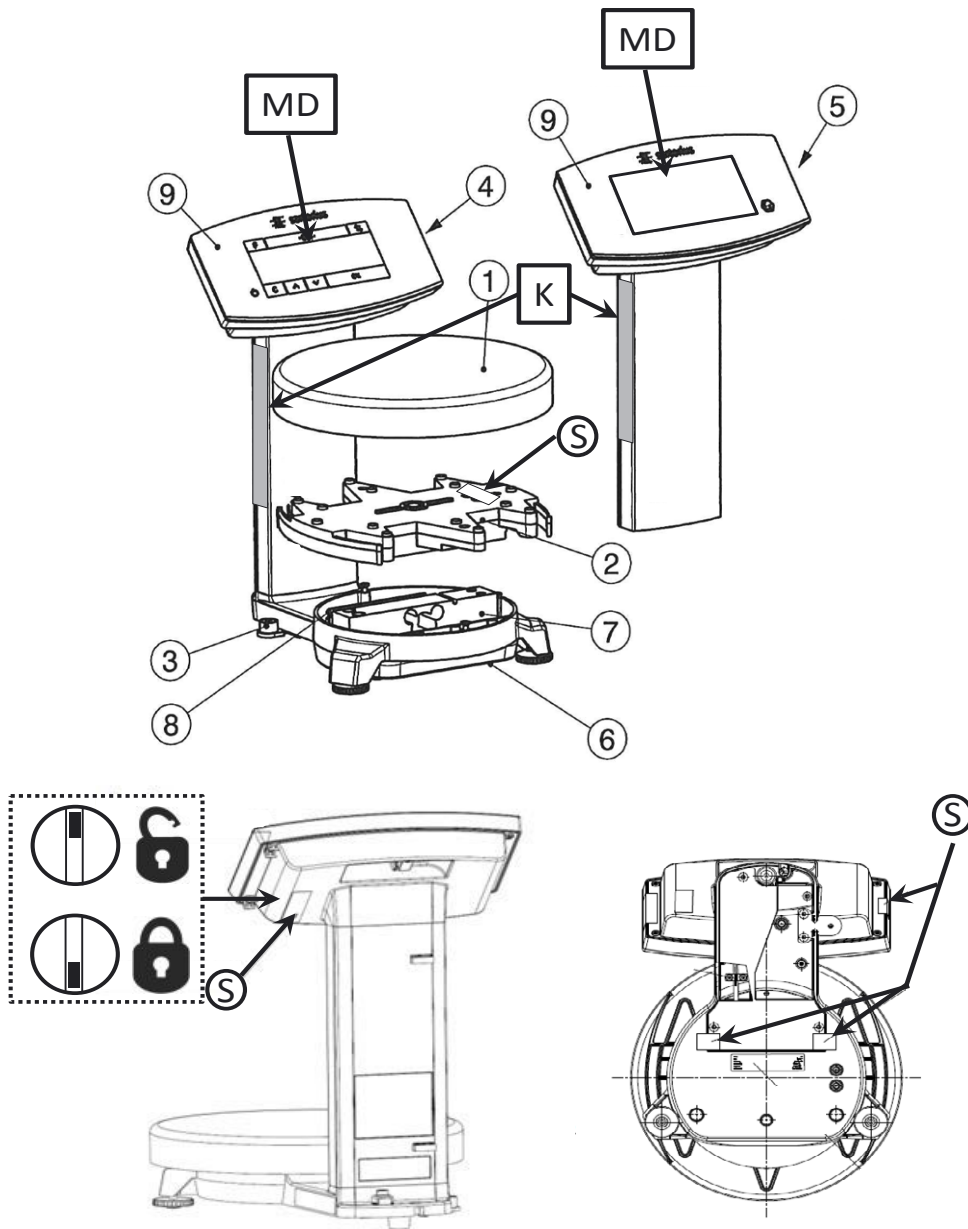

Typ Waage / Type weighing instrument / Type d'instrument de pesage / Tipo del instrumento de pesaje / Tipo di strumento per pesare: PMA-EV, PMA-HD
 EG Baumusterprüfbescheinigung / EC type-examination certificate / Certificat d'examen UE de type / Certificado de examen UE de tipo / Certificato di esame UE del tipo : UK3066

- ① Schale / Pan / Plateau de pesée / Plato de pesaje / Piatto di pesata
- ② Unterschale / Subpan / Plateau inférieur / Plato inferior / Piatto inferiore
- ③ Libelle / Bubble level / Nivelles sphérique / Nivel de burbuja / Livella
- ④ Segmentiertes LCD-Display / Segmented LCD display / Afficheur à segments (LCD) / Visualizador de segmentos (LCD) / Visualizzatore a segmenti (LCD)
- ⑤ LCD Graphik-Display / LCD graphic display / Afficheur graphique (LCD) / Visualizador gráfica (LCD) / Visualizzatore grafico (LCD)
- ⑥ Grundplatte / Base plate / Plaque de montage / Placa base / Piastra di base
- ⑦ Wägesystem / Weighing system / Système de pesée / Sistema pesador / Sistema di pesatura
- ⑧ Auswertelektronik / Evaluation electronics / Dispositif de détection électronique / Electrónica de evaluación / Elettronica per la valutazione
- ⑨ Anzeigeeinrichtung / Indicating device / Dispositif indicateur / Dispositivo indicador / Dispositivo di visualizzazione

MD

Metrologische Daten Max, Min, e und wenn vorhanden d / Metrological data Max, Min, e and if existent d / Données métrologiques : Max, Min, e et, si disponible, d / Datos metrológicos: Máx, Mín, e y d, si está disponible / Dati metrologici: Max, Min, e, e d se disponibile

S

Sicherungsstempel (selbstklebende Marke oder Plombe) / Protective mark (self-adhesive mark or seal) / Marque de protection (marque ou sceau autocollant) / Sello de seguridad (marca autoadhesiva o precinto) / Sigillo di protezione (bollino autoadesivo o piombo)

K

Kennzeichnungsschild mit CE-Zeichen / Descriptive plate with CE-sign / Plaque d'identification avec marque CE de conformité / Placa de características con la marca CE / Etichetta d'identificazione con marchio CE



Programmverriegelungsschalter / Menu access switch / Commutateur d'accès au menu / Interruptor de bloqueo de programa / Commutatore di accesso al menu



gesperrt / locked / verrouillé / bloqueado / bloccato



offen / open / ouvert / abierto / aperto

Sartorius Lab Instruments GmbH & Co. KG
Otto-Brenner-Strasse 20
37079 Goettingen, Germany

Phone: +49.551.308.0
www.sartorius.com

The information and figures contained in these instructions correspond to the version date specified below.

Sartorius reserves the right to make changes to the technology, features, specifications and design of the equipment without notice.

Masculine or feminine forms are used to facilitate legibility in these instructions and always simultaneously denote the other gender as well.

Copyright notice:

This instruction manual, including all of its components, is protected by copyright. Any use beyond the limits of the copyright law is not permitted without our approval. This applies in particular to reprinting, translation and editing irrespective of the type of media used.

© Sartorius Germany

Last updated:
08 | 2018