

Operating Instructions

Sartorius Moisture Analyzer

Models MA100
Electronic Moisture Analyzer

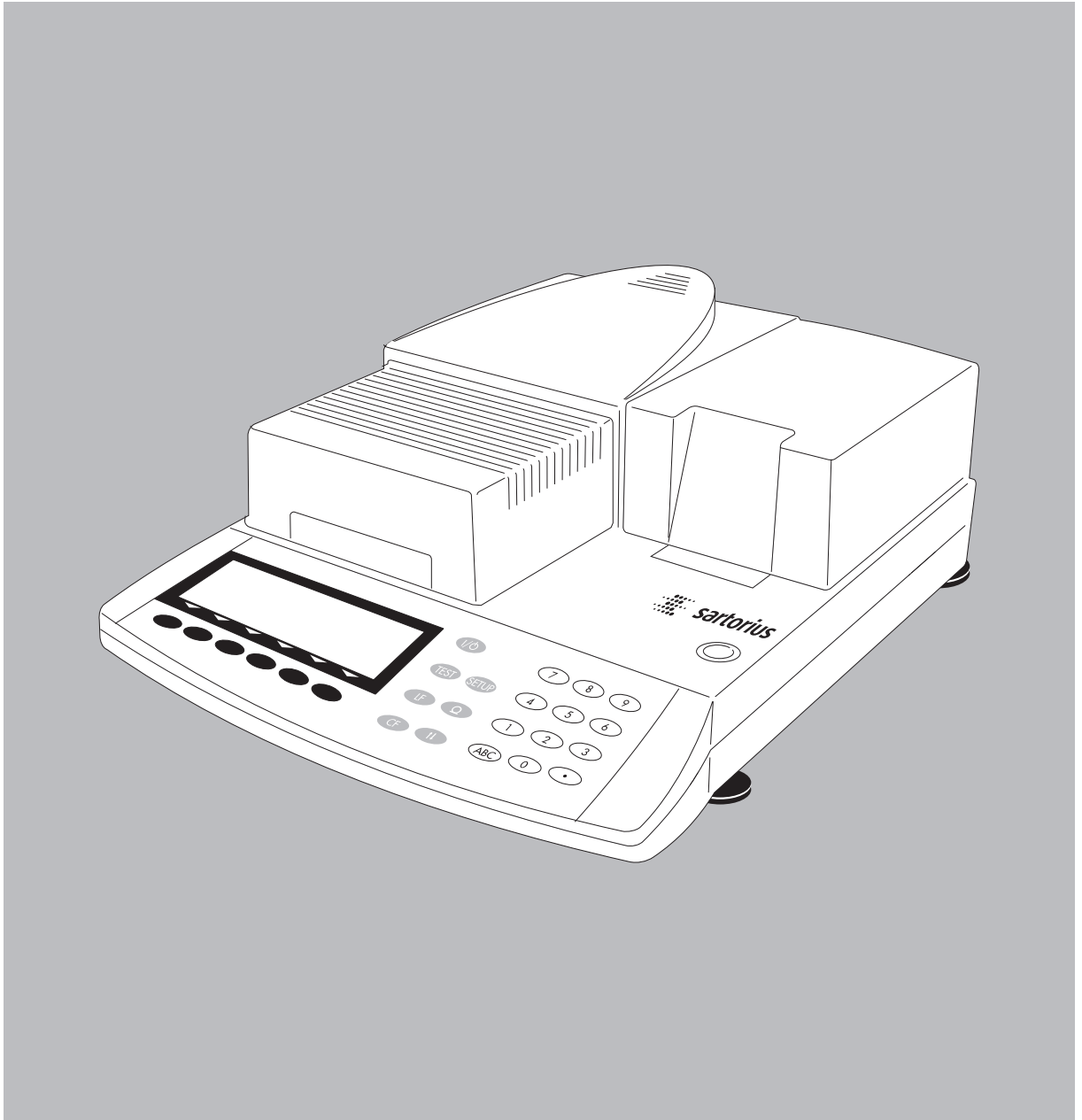

Intended Use

The MA100 Moisture Analyzer can be used for quick and reliable determination of the moisture content of liquid, pasty and solid substances according to the method of thermogravimetry.

The moisture analyzer saves work and speeds up your routine procedures through the following features:

- Fast analysis time, gentle and uniform sample drying due to the coiled quartz heating element (CQR) or round ceramic IR heating element
- Quick determination of the drying parameters and easy-to-set drying programs due to automatic determination of the shutoff parameters for semi-automatic analyses (SPRM* mode)
- Setting the fully automatic end-point recognition parameter for an analysis only requires that you enter the drying temperature
- Optimal adjustment of the moisture analyzer to other methods of analysis and adaptation to difficult samples due to the semi-automatic end-point recognition
- Quick drying without the risk of scorching the sample and preheating adapted to the sample's heat sensitivity by selecting an adequate heating program
- High flexibility for analyzing the widest variety of samples and storable programs to save time when changing to different types of samples
- User-definable printouts that can be customized before moisture analysis runs
- Brief instructions on the moisture analyzer provide quick answers to frequently asked questions

The moisture analyzer is ideal as a measuring and test instrument for incoming inspection, in-process control and quality control due to the following features:

- Convenient and reliable control of the accuracy of the moisture analyzer according to the DIN/ISO standards by using the internal calibration weight
- reproTEST for quick determination of the standard deviation
- ISO/GLP-compliant recording capability; printouts can also be generated with an (optional) built-in printer
- Optimal process control and quality monitoring due to the statistical evaluation of up to 9,999 analyses/programs
- Password-protected drying parameters

The moisture analyzer meets the highest requirements placed on the accuracy and reliability of weighing results through the following features:

- High repeatability by limiting the exposure of the weighing system to vibration during the start of an analysis and better access to the sample chamber due to the motorized heating unit
- Excellent readability under any lighting conditions and backlit display for minimization of reading errors
- Removable sample chamber base plate for easy cleaning of the sample chamber and protection of the weighing system from debris

Model designations

MA100X-0YZV1, where X may be C, H or Q. C for Ceramic Heater, H for Halogen Heater, Q for Quartz heater, rated 100 – 120 Vac or 200 – 240 Vac, 50/60 Hz, 650 VA for Ceramic Heater; 400 VA for Halogen Heater; 650 VA for Quartz Heater. Y may be 00 or CE; Z may be 115 or 230 for 100 – 120 Vac and 200 – 240 Vac respectively.

Symbols

The following symbols are used in these instructions:

- indicates steps you must perform
- indicates steps you must perform only under certain conditions
- > describes what happens after you have performed a certain step
- indicates an item in a list
- ⚠ indicates a hazard

* SPRM = Swift Parameter Adjustment to a Given Reference Method

Contents

Intended Use	2	“isoTEST” Calibration Adjustment Functions.	51
Contents	3	Heater Adjustment	51
Warning and Safety Information.	4	Weighing System Settings.	51
Getting Started		Hardware Tests.	56
Storage and Shipping Conditions	5	Adjusting the Heater.	58
Unpacking	5	Heating Unit Adjustment	58
Instructions for Recycling	5	Data Output.	59
Equipment Supplied	5	Output to the Moisture Analyzer.	59
General View of the Moisture Analyzer	6	Interface Description	61
Connecting the Moisture Analyzer to AC Power.	7	Data Output Format	62
Leveling the Moisture Analyzer.	8	Data Input Format	63
Selecting the Brief Instructions.	8	Digital Input/Output Ports	65
Turning On the Analyzer; Opening and Closing the Sample Chamber.	8	Pin Assignment Chart	66
		Cabling Diagram.	67
Operating Design		Error Codes	68
Keys	9	Care and Maintenance	
Operation: Analysis and Test Functions.	10	Service	70
Menu Operation and Drying Results	11	Repairs	70
Data Output.	11	Cleaning	70
Error Codes	12	Replacing the Fan Air Filter.	70
Saving Data	12	Replacing the Fuses	71
		Disassembling or Replacing the Heating Unit	71
		Safety Inspection	71
Configuring the Moisture Analyzer		Overview	
Setting the Language	13	Specifications.	72
Setting the Device Parameters.	14	Accessories (Options)	73
Entering or Changing the Password	15	Declarations of Conformity.	74
Example: Setting the Time and Date.	17	Index	77
Device Parameters (Overview)	18		
Configuring the Printout	20	Appendix	
Device Information.	24	Entering the General Password	
Operating the Moisture Analyzer			
Weighing Function.	25		
Basics.	25		
Preparation	27		
Adjustment to an Existing Measuring System.	27		
Preparing a Sample.	28		
Setting the Drying Parameters.	30		
Drying Parameters (Overview)	30		
Displaying Analysis Data.	35		
Identification Codes	35		
Mode	36		
Info	36		
Statistics	36		
Examples	37		

Warning and Safety Information

This moisture analyzer complies with the European Council Directives as well as international regulations and standards for electrical equipment, electromagnetic compatibility, and the stipulated safety requirements. Improper use or handling, however, can result in damage and/or injury.

Read these operating instructions thoroughly before using your moisture analyzer to prevent damage to the equipment. Keep these instructions in a safe place.

Follow the instructions below to ensure safe and trouble-free operation of your moisture analyzer:

- ⚠ Use the moisture analyzer only for performing moisture analysis of samples. Any improper use of the analyzer can endanger persons and may result in damage to the analyzer or other material assets
- ⚠ Samples or containers (e.g., beakers or graduated flasks) that are too large or bulky to permit complete closure of the sample chamber hood must not be placed in the analyzer.
- ⚠ Do not use this moisture analyzer in a hazardous area/location; operate it only under the ambient conditions specified in these instructions
- The moisture analyzer may be operated only by qualified persons who are familiar with the properties of the sample to be analyzed
- ⚠ Make sure before getting started that the voltage rating printed on the manufacturer's label is identical to your local line voltage (see the section on "Connecting the Moisture Analyzer to AC Power" in the chapter entitled "Getting Started")
- The device comes with a power supply that has a grounding conductor
- The only way to switch the power off completely is to unplug the power cord. Install the device in such a way that it is easy to unplug the power cord.
- Position the power cable so that it cannot touch any hot areas of the moisture analyzer

- Use only extension cords that meet the applicable standards and have a protective grounding conductor
- Disconnecting the ground conductor is prohibited
- Connect only Sartorius accessories and options, as these are optimally designed for use with your moisture analyzer
- Protect the moisture analyzer from contact with liquid
- If there is visible damage to the moisture analyzer or power cord: unplug the equipment and lock it in a secure place to ensure that it cannot be used for the time being

- ⚠ Clean your moisture analyzer according to the cleaning instructions only (see "Care and Maintenance")

Do not open the analyzer housing. If the seal is broken, this will result in forfeiture of all claims under the manufacturer's warranty.

In case you have any problems with your moisture analyzer:

- contact your local Sartorius office, dealer or service center



Warning: Severe Burns!

- When setting up the moisture analyzer, leave enough space to prevent heat from building up and to keep your analyzer from overheating:
 - leave 20 cm (about 8 inches) around the moisture analyzer
 - 1 m (3 ft.) above the device
- Do not put any flammable substances on, under or near the moisture analyzer, because the area around the heating unit will heat up
- Be careful when removing the sample from the chamber: the sample itself, the heating unit and the sample pan used can still be extremely hot
- Do not remove the heating unit during operation: the heating element and its protective glass panels can get extremely hot!
- Prevent excess heat build-up around the analyzer

Hazards for persons or equipment posed by using specific samples:



Fire



Explosion

- Flammable or explosive substances
- Substances that contain solvents
- Substances that release flammable or explosive gases or vapors during the drying process

In some cases, it is possible to operate the moisture analyzer in an enclosed nitrogen atmosphere to prevent the vapor released during drying from coming in contact with oxygen in the surrounding atmosphere. Check on a case-to-case basis whether this method can be used, because installation of the analyzer in too small an enclosed space can affect its functions (for instance through excessive heat build-up within the analyzer). When in doubt, perform a risk analysis.

The user shall be liable and responsible for any damage that arises in connection with this moisture analyzer.



Poisoning



Caustic burns

- Substances containing toxic or caustic or corrosive substances: These may be dried only under a fume hood. The value for the "lower toxic limit" in a work area must not be exceeded.

Corrosion:

- Substances that release aggressive vapors during the heating process (such as acids): In this case we recommend that you work with small sample quantities. Otherwise, vapors can condense on cold housing parts and cause corrosion.

The user shall be liable and responsible for any damage that arises in connection with this moisture analyzer.

Getting Started

The moisture analyzer consists of a heating unit, a weighing system, a display and control unit and an optional printer. In addition to the socket for AC power (mains supply), it also has an interface port for connecting peripheral devices, such as a PC, an external printer, etc.

Storage and Shipping Conditions

Allowable storage temperature:
0 °C... + 40 °C
+32 °F... + 104 °F

Do not expose the moisture analyzer unnecessarily to extreme temperatures, moisture, shocks, blows or vibration.

Unpacking the Moisture Analyzer

- After unpacking the moisture analyzer, check it immediately for any visible damage as a result of rough handling during shipment
- If this is the case, proceed as directed in the chapter entitled “Care and Maintenance,” under the section on “Safety Inspection”

It is a good idea to save the box and all parts of the packaging until you have successfully installed your moisture analyzer. Only the original packaging provides the best protection for shipment. Before packing your moisture analyzer, unplug all connected cables to prevent damage.

Instructions for Recycling the Packaging

To ensure adequate protection for safe shipment, your moisture analyzer has been packaged to the extent necessary using environmentally friendly materials. After successful installation of the moisture analyzer, you should return this packaging for recycling because it is a valuable source of secondary raw material. For information on recycling options, including recycling of old weighing equipment, contact your municipal waste disposal center or local recycling depot.

Equipment Supplied

The equipment supplied includes the components listed below:

- Moisture analyzer
- Power cord
- Pan support
- Shield disk
- Dust cover for keypad
- 80 disposable aluminum sample pans
- 1 pair of forceps
- 3 cards with brief instructions in 6 different languages

Installation Instructions

The moisture analyzer is designed to provide reliable results under normal ambient conditions in the laboratory and in industry. When choosing a location to set up your moisture analyzer, observe the following so that you will be able to work with added speed and accuracy:

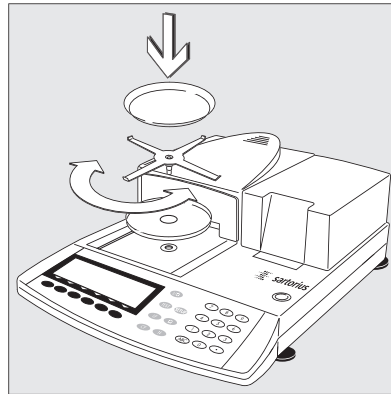

- Set up the moisture analyzer on a stable, even surface that is not exposed to vibrations
- Avoid placing the analyzer in close proximity to a heater or otherwise exposing it to heat or direct sunlight
- Avoid exposing the moisture analyzer to extreme temperature fluctuations
- Protect the moisture analyzer from drafts that come from open windows or doors
- Keep the moisture analyzer protected from dust, whenever possible
- Protect the moisture analyzer from aggressive chemical vapors
- Do not expose the analyzer to extreme moisture
- Make sure to choose a place where excessive heat cannot build up. Leave enough space between the moisture analyzer and materials that are affected by heat.

Conditioning the Moisture Analyzer

Moisture in the air can condense on the surfaces of a cold moisture analyzer whenever it is brought into a substantially warmer place. If you transfer the moisture analyzer to a warmer area, make sure to condition it for about 2 hours at room temperature, leaving it unplugged from AC power. Afterwards, if you keep the moisture analyzer connected to AC power, the continuous positive difference in temperature between the inside of the moisture analyzer and the outside will practically rule out the effects of moisture condensation.

Setting up the Moisture Analyzer

- Position the components listed below in the order given:
 - Dust cover over the keypad
 - Shield disk
 - Pan support; turn to the left or right, press slightly until it stops and snaps into place
 - Disposable sample pan

General View of the Moisture Analyzer

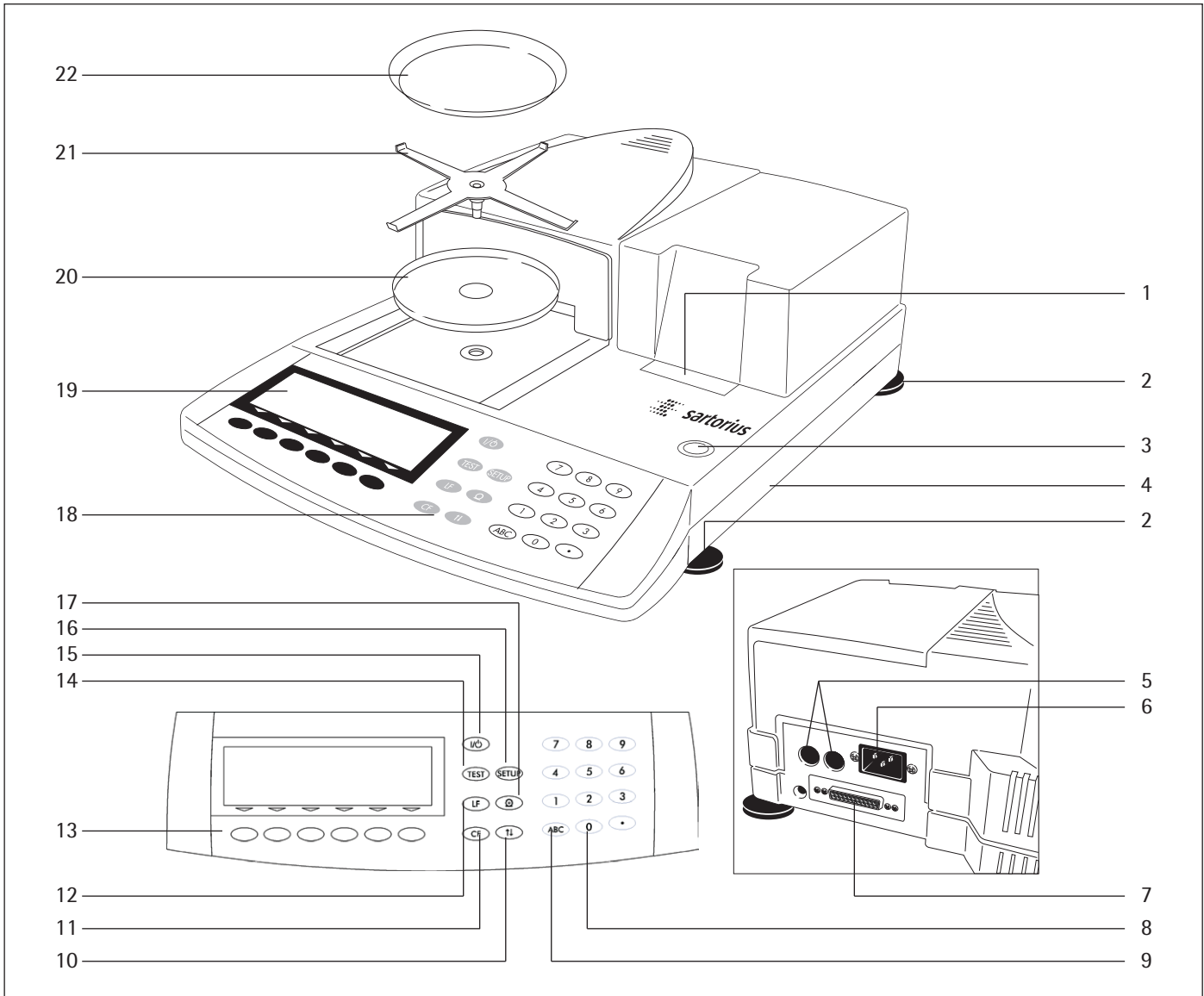

No.	Designation	Order no. for replacement	No.	Designation	Order no. for replacement
1	Internal printer (option)	YDS01MA	14	“isoTEST” key (calibration/ adjustment functions)	
2	Leveling foot	69MA0091	15	On/off key	
3	Level indicator		16	“Setup” key	
4	Brief instructions		17	Print key	
5	Fuse		18	Keypad	
6	Power socket		19	Display	
7	Interface port		20	Shield disk	69MA0093
8	Keys for numeric input		21	Pan support	69MA0092
9	Toggle key for alphabetic input		22	Disposable sample pan	6965542 (80 units)
10	Key for opening and closing the sample chamber by the heating unit			Not shown:	
11	CF key (clear function)			Dust cover for keypad	6960MA01
12	Line feed; press the key to advance the paper by one blank line			Forceps	69MA0072
13	6 function keys (soft keys)				

Connecting the Moisture Analyzer to AC Power

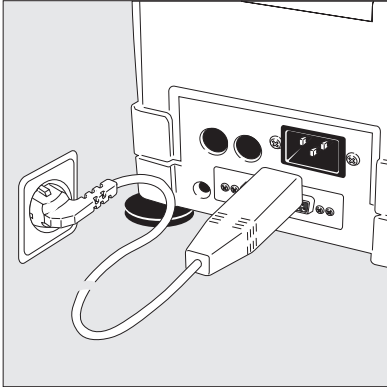

- Check the voltage rating and the plug design
- The heating unit of the moisture analyzer has been factory-set to 230 or 115 volts for technical reasons. The voltage has been set as specified on your order. The voltage setting is indicated on the manufacturer's label (see the bottom of the analyzer), for example:
 - 230 volts: MA.....**230**..
 - 115 volts: MA.....**115**..

⚠ If they do not match: To have the voltage setting changed, contact your local Sartorius office or dealer, and do not operate your moisture analyzer in the meantime!

- Use only
 - Original power cords
 - Power cords approved by a certified electrician/Sartorius service technician
 - If you need to connect an extension cord:
 - Use only a cable with a protective grounding conductor

- Connecting the moisture analyzer, rated to Class I, to AC power (mains supply): The device comes with a power supply that has a grounding conductor. The moisture analyzer must be plugged into a properly installed wall outlet which has a protective grounding conductor (PE). The only way to switch the power off completely is to unplug the power cord. Install the device in such a way that it is easy to unplug the power cord.

Safety Precautions

If you use an electrical outlet that does not have a protective grounding conductor, make sure to have an equivalent protective conductor installed by a certified electrician as specified in the applicable regulations for installation in your country. The protective effect must not be negated by using an extension cord without a protective grounding conductor.

Information on Radio Frequency Interference

See EU Declaration of Conformity and FCC Supplier's Declaration of Conformity in the appendix.

Connecting Electronic Devices (Peripherals)

- Make absolutely sure to unplug the moisture analyzer from AC power before you connect or disconnect a peripheral device (printer or PC) to or from the interface port.

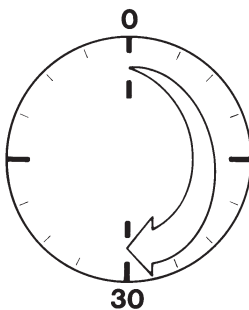
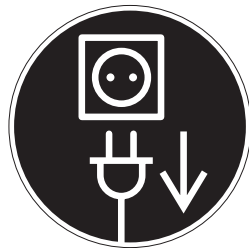

Warmup Time

To deliver exact results, the moisture analyzer must warm up for at least 30 minutes after initial connection to AC power or after a relatively long power outage. Only after this time will the moisture analyzer have reached the required operating temperature.

Charging the Built-in Rechargeable Battery

Before initial operation, leave the moisture analyzer connected to the line current (mains supply) for at least 10 hours to charge the built-in rechargeable battery. When the analyzer is disconnected from line current, the analysis data is retained in memory for approximately three months.

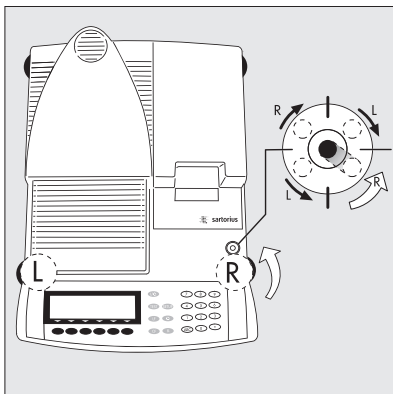

Leveling the Moisture Analyzer

Purpose:

- To compensate for unevenness at the place of installation
- To achieve perfectly horizontal positioning of the moisture analyzer for consistent repeatability
- This is necessary especially for testing liquid samples that need to be at a uniform level in the disposable sample pan

Always level the moisture analyzer again any time it is moved to a different location.

Only the 2 front feet are used for leveling.

- Retract the both rear feet
- Turn the 2 front feet as shown in the illustration until the air bubble is centered within the circle of the level indicator
- > Several leveling steps are usually required
- Extend the 2 rear feet until they touch the surface on which the moisture analyzer rests

Selecting the Brief Instructions



The moisture analyzer has separate cards with brief instructions on its most important functions. The following languages are included:

- English/Dutch
- German/Italian
- French/Spanish

To exchange the brief instruction card:

- Pull out the brief instruction card on the right (you need to use a little force to overcome the resistance which is used to keep the card in place)
- To insert the card:
 - Slide the selected card into the slot
 - Pull out the card on the right to remove it, if necessary

Turning On the Analyzer; Opening and Closing the Sample Chamber

- To turn on the analyzer: Press the  key
- To open or close the sample chamber: Press the  key
- > The motor opens or closes the sample chamber

Setting the Language

- See the section on “Setting the Language” in the chapter entitled “Configuring the Moisture Analyzer”

Setting the Date and Time

- See the section on “Setting the Device Parameters” in the chapter entitled “Configuring the Moisture Analyzer”

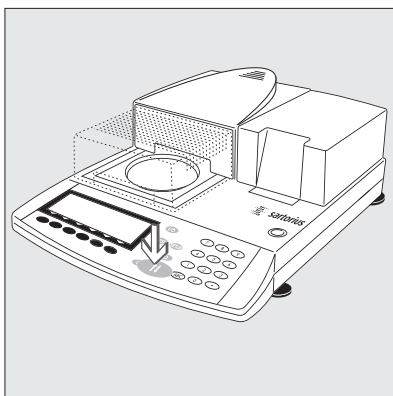

Operating Design

Operation of the moisture analyzer follows a standardized “philosophy” which is described below.

Keys

The moisture analyzer is operated either using the keys on the display and control unit or via a connected PC. Operation using the keys is described in the following.

Labeled Keys

These keys always have the function indicated, but are not available at all times. Availability of these functions depends on the current operating status of the moisture analyzer and its menu settings.

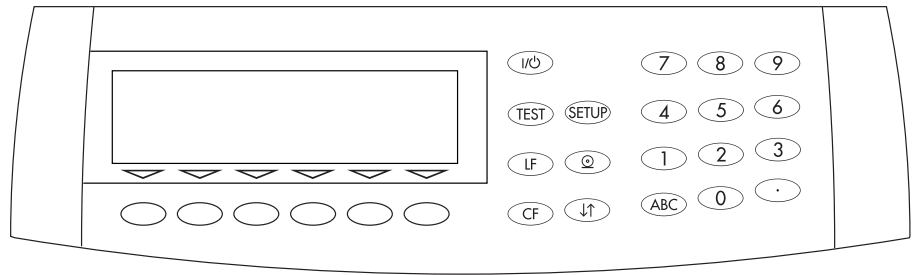

The keys have the following functions:

- I/O On/off key
Turns the moisture analyzer on/off. The moisture analyzer remains in standby mode
- TEST isoTEST
Calibration/adjustment of the weighing system and hardware tests can be carried out
- SETUP Configuring the moisture analyzer
Access to the Setup menu; exit Setup
- LF Line Feed
(Optional) printer advances the paper by one line
- Q Data Output
Press this key to output displayed data via the interface port or to generate printouts using the (optional) printer
- CF Clear Function
Deletes keypad input
Interrupts calibration/adjustment routines
- ↕ Arrow Key
Opens or closes the sample chamber
- 0 ... 9 . Numeric Keys
see the section entitled “Numeric Input”
- ABC Alphabetic Keys
see the section entitled “Text Input”

Numeric Input

To enter numbers: Press the 0 1 ... 9 . keys

To store numbers entered: Press the corresponding soft key

To interrupt/cancel numeric input digit by digit: Press the CF key

Text Input

- To enter numbers: See the section entitled “Numeric Input”
- To enter letters or characters: Press the ABC key
- > Letters are displayed in the bottom line for selection
- To select a different letter: Press the corresponding soft key to change the letter shown
- To select the letter/character shown: Press the corresponding soft key
- > The selected letter is shown on the display
- Enter the next letter/character, if desired, as above
- To exit the letter input mode (i.e. if the last character entered is a letter): Press the ABC key
- To store a word: Press the corresponding soft key (e.g., I D)
- To delete an input or character: Press CF key
- To delete user data: Enter . “decimal point” or a space “ ” and confirm by pressing Enter

Function Keys (Soft Keys)

The current function of a soft key is indicated in the bottom line of the display (footer).

Texts (as abbreviations) or symbols can be displayed in the example shown below.

Texts (Examples)

Info:
Information about the "Phase Drying" program

Prog.:
Select/configure the drying program

Stat.:
Statistics display/delete

ID:
Enter the ID number

Mode:
Change the parameters

Tare:
Tare the sample pan

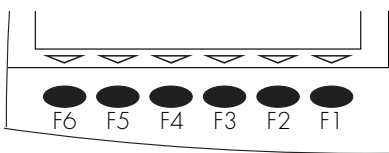

The function keys are numbered (F1) through (F6), from right to left.

Symbols
The bottom line shows the following symbols:

- ◀◀ Return to Setup menu (in the Setup menu: exit the Setup program)
- ◀ Go back to the higher selection level
- Show sub-items under the active item
- ⬆ Move upward in the input/output window
- ⬇ Move downward in the input/output window
- ⬇ Set the selected menu parameter

There are two fundamentally different types of display:

- display for analysis and test functions
- display for menu parameter settings (e.g., SETUP, Mode, ID) and final results (Info, Statistics)

Operation

Analysis and Test Functions

This display is divided into nine sections.

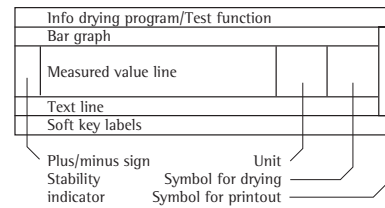

Example: Moisture Analysis

Info Drying Program Line

The following information is displayed here:

- Program name with 10 characters max. (factory setting), e.g. BUTTER or
- Number of the selected drying program, e.g. P1 (shown when "Drying parameter: Mea. No. # with automatic Counter: On" is configured)
- Temperature settings
- End of measurement criteria

Bar Graph:

The bar graph indicates the percentage by which the weighing system's capacity is "used up" by the current sample on the pan

The bar graph is shown if you have selected **minimum and maximum initial weight or target value, tolerance in %.**

The following symbols may be displayed here:

- 0% Lower load limit for initial sample weight
- 100% Upper load limit for initial sample weight
- ▬ Bar graph showing 10 % intervals
- Minimum tolerance
- = Target value
- + Maximum tolerance

Plus/Minus Sign:

A plus or minus sign (+ or -) is shown here for a weight value (e.g., a calculated value, when weighing in percent).

Measured Value Line:

This section shows the weighed or calculated value or alphanumeric input.

Unit and Stability:

When the weighing system reaches stability, the weight unit or calculation unit is displayed here.

Symbol for Drying:

During the drying program, the following symbol is displayed here:



Drying in progress

Symbol for Printout:

During the printout of the analysis results and other data, the following symbols appear in this column:



Print

Text Line:

Additional information is displayed here (e.g., operating state, operator guidance prompts, analysis temperature and measuring time, etc.)



Text line example for operator guidance (e.g., "TARE: Tare sample pan")

Soft Key Labels:

The current functions (abbreviations) of the arrow keys (soft keys) are indicated here. Please note that when we say "press the X soft key," we are referring to the actual key indicated below the soft key label displayed.

Menu Operation and Drying Results

This display is divided into three sections.

Line for Operating State
Input and Output Window
Soft Key Labels

Line for Operating State:

The line for operating state indicates the function of the current screen page. In the Setup menu, the current menu path is shown here.

Example for Setup, Language:

SETUP	LANGUAGE

Input and Output Window:

This window contains either detailed information (e.g., on the active application) or a pick list. A selected item is displayed inversely (white letters on a black background). You can also enter information in an active field in this window using the alphanumeric keys.

Example for Setup, Parameter Settings:

o Normal vibration
Strong vibration

The following symbol in the input or output window indicates:

- o this symbol marks the saved menu setting

Soft Key Labels:

See “Function Keys (Soft Keys)” on the previous page

Parameter Settings

The parameters are configured in menus. These menus have several levels.

Example of the Setup Menu:

- To select a parameter:
Press the **SETUP** key
- To move within a menu level:
Press the **▲** or **▼** soft keys
- To select a menu item (submenu):
Press the **➤** soft key

To set a parameter:

- Press the **▲** or **▼** soft keys repeatedly until the desired setting is selected (displayed inversely)
- Confirm your selection by pressing the **↓** soft key

To change the numeric value of a parameter:

- Press the **▲** or **▼** soft keys repeatedly until the desired setting is selected (displayed inversely)
- Enter the desired number using the **0** **1** ... **9** **.** keys or the **ABC** soft key and enter the desired letters
- Confirm your selection by pressing the **↓** soft key

To exit Setup: Press **SETUP** or the **<<** soft key

Data Output

You can choose between:

- internal printer (option)
- interface port for:
 - Sartorius printer (such as the YOP03-01)
 - computer (PC)
 - process logic controller (PLC)
 - universal remote control switch

(Internal/External) Printer

You can configure the print functions to meet your individual requirements by selecting the corresponding menu code in Setup. The printouts can be generated as standard or ISO/GLP-compliant printouts.

ISO: International Organization for Standardization

GLP: Good Laboratory Practice

You can have printouts generated automatically, or by pressing **Ⓞ**; printout generation can be dependent on or independent of the stability or time parameters (for example, automatic when a drying program starts, at specific time intervals, at the end of a drying program).

See the section on “Data Output Functions” in the chapter entitled “Operating the Moisture Analyzer” for a detailed description of data output options.

Interface Port

You may choose to connect a different peripheral device, such as one of the following, to the interface port instead of or in addition to the internal printer:

- external printer
- status indicators with digital input ports
- process logic controller with digital input/output port
- a computer (PC) with a communications port

The moisture analyzer can be monitored and remote-controlled via the interface port.

For a detailed description, see the section on “Data Output Functions” in the chapter entitled “Operating the Moisture Analyzer.”

Error Codes

If you press a key that has no function, or which is blocked at a certain point in an application program, this error is indicated as follows:

- a double-beep is sounded as an acoustic signal if the key has no function
- invalid input is indicated by an error message
- incorrect operation is indicated by an error code or error message

The response to an operator error is identical for all operating modes. See the chapter entitled “Error Codes” for a detailed description.

Saving Data

Storing Parameter Settings

The parameter settings in the Setup menu and for drying programs are active when you switch on the moisture analyzer. The parameter settings, selected with the **M o d e** soft key during an analysis, are not saved (exception: limits for the control function).

In addition, the factory settings can be restored.

Saving Parameter Settings

You can assign passwords in order to block access to:

- user-configured drying programs
- setting mode for device parameters
- printout configuration

If no password has been assigned, anyone can access drying programs, “SETUP: Device parameters” and “Printout configuration” without entering a password.

If you assign a password and then forget what the word is, you can use the General Password (see Appendix) to access these menus.

Configuring the Moisture Analyzer

Purpose

You can configure your moisture analyzer to meet individual requirements by entering user data and setting selected menu parameters in the Setup menu.

The Setup menu is divided into the sections:

- Language
- Device parameters
- Printout configuration
- Device information

Setting the Language

You can choose from 5 languages for the information display:

- German
- English (factory setting)
- English with U.S. date/time format
- French
- Italian
- Spanish

Example: Selecting the language: "U.S. Mode"

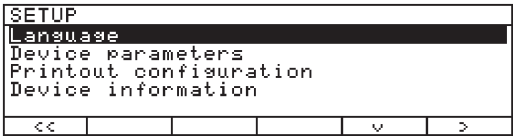
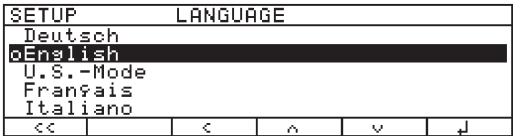
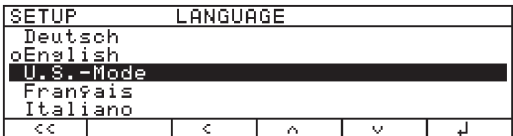
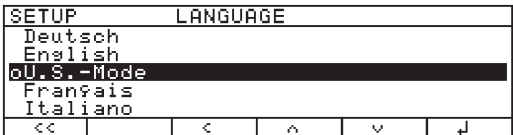
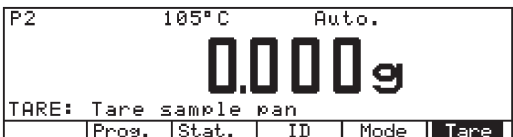
Step	Key (or Instruction)	Display/Printout
1. Select Setup menu		
2. Confirm the language	➤ soft key	
3. Set the language "U.S. Mode"	⤴ soft key	
4. Store the language	⤵ soft key	
5. Exit Setup	⏪ soft key	

Setting the Device Parameters (DEVICE)

Purpose

Device configuration, i.e., to meet individual requirements by selecting predefined menu parameters in the Setup menu. You can block access to the menu by assigning a password.

Features

The device parameters are combined in the following groups:

- Password to the Setup menu
- User ID
- Weighing parameters
- Interface
- Internal printer (option)
- Keypad
- Display
- Clock
- Extra functions
- Factory settings

You can view, enter or change the following parameters:

Password

- Password for access to the SETUP menu: "Device parameters," "Printout configuration" and "Drying programs" (8 characters max.)

User ID

- ID codes:
User ID (20 characters max.)

SETUP	DEVICE	USER ID
User ID:		SMITH2345
<<	<	>

- Weighing parameters
 - Adjustment to the ambient conditions
 - Weight set number for calibration/adjustment: W ID (weight ID; 14 characters max.)

- Exact calibration weight value for calibration/adjustment of the analyzer, such as for adjustment according to a DKD certificate (see the section on "Calibration/Adjustment" in the chapter entitled "Operating the Moisture Analyzer")

Interface

- SBI operating mode
Simple record of analysis results for PC or external printer, factory setting for YDP03-OCE printers
Format: baud rate, number of data bits, parity, stop bits, handshake

- xBPI operating mode
Function-oriented interface with clear data transmission
Network address: enter a number from 0 to 31; factory setting: 0

- Sartonet via RS-485 interface
Network address: enter a number from 0 to 31; factory setting: 1

Keys

- CF function: delete entire input or last character

- Block key functions

Display

- Background
- Contrast/angle of the display (enter a number from 0 to 4; factory setting: 2)

Clock

- Time (hh.mm.ss; hh can be entered without a preceding zero)
- Date (dd.mm.yy or mm.dd.yy when you select "English with U.S. date/time" as the language")

Extra Functions

- Acoustic signal on or off
- Functions for external universal remote control switch, extra keyboard or bar code scanner

Factory Settings

Parameters: The factory-set configurations are identified by an "o" in the list starting on page 18.

Preparation

Display existing "Device parameters"

- Select the Setup menu:
Press the **SETUP** key

> SETUP is displayed:

SETUP
Language
Device parameters
Printout configuration
Device information
<< < > >>

- Select "Device parameters":
Press the **↵** and **➤** soft keys

If no password has been assigned, anyone can access "SETUP: Device parameters" and "Printout configuration" without entering a password

If you have already assigned a password:

> The password prompt is displayed

- If access is blocked by a password: enter the password using the alphanumeric keys

- If the last character of the password is a letter: conclude input by pressing **ABC**

- Confirm the password and display "Device parameters":
Press the **↵** soft key

> Device parameters are displayed:

SETUP	DEVICE
Password	
User ID	
Weigh. parameters	
Interface	
Internal printer	
<<	<
>	>>

Entering or Changing the Password

- Password for access to the following functions, entered with 8 characters max.:

- SETUP parameters
- Data record configuration
- Edit or copy drying program

- Select the Setup menu:
Press the **SETUP**

> SETUP is displayed

- Select parameters:
Press the **↵** and **➤** soft keys

If you have already assigned a password:

> The password prompt is displayed:

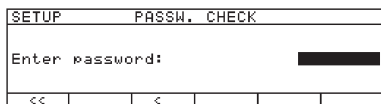

- Enter the password

- Confirm the password and display the parameters:
Press the **↵** soft key

- Write down the password here for easy reference:
Password =

If you assign a password and then forget what the word is:

- Enter the General Password (see Appendix)

- Confirm the password and display the parameters:
Press the **↵** soft key

> Parameters are displayed

- Select the password-setting function:
Press the **↵** or **↶** soft key repeatedly and **➤** soft key until

> **Password:** and any existing password are displayed:

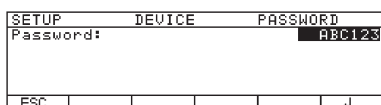

- New password: Enter the numbers and/or letter of the new password (8 characters max.)

If "none" is displayed as a password: this means no password has been assigned

To delete the user password: Enter **0** and confirm

- To confirm your entry:
Press the **↵** soft key

- Exit the Setup menu:
Press the **<<** soft key

> Restart the application

Extra Functions

- Exit the Setup menu:
Press the **<<** soft key

> Restart the application

- Printout the parameter setting:
- If "Device parameters" are displayed:
Press the **@** soft key

> Printout (example)
Lines with more than 20 characters are truncated

```

-----
SETUP
-----
                DEVICE
-----
User ID
  User ID:      ABC123456
Weighing parameters
Adapt filter
  Normal vibration
Calibration/Adjust
  Wt.ID (W ID): 123
                Cal./Adj. wt.:
                50.000 g
Interface
SBI
  Baudrate      1200 baud
  Number of data bit
                7 bit
  Parity
                Odd
  Number of stop bit
                1 stop bit
  Handshake mode
  Hardware 1 char
  
```

etc.

- Reset the device parameters to the factory settings:
See the section on selecting the factory settings in the chapter entitled "Device Parameters (Overview)"

Example 1:

Adapt filter to the ambient condition: “Strong vibration”

Step	Key (or Instruction)	Display/Printout
1. Select Setup menu		<pre> SETUP Language Device parameters Printout configuration Device information << v >> </pre>
2. Select and confirm “Device parameters”	↓ soft key, then the → soft key	<pre> SETUP DEVICE Password User ID Weigh. parameters Interface Internal printer << < v >> </pre>
3. Select and confirm “Weigh. parameters”	↓ soft key twice, then the → soft key	<pre> SETUP DEVICE WGH. PARAM. Adapt filter Calibration/adjustment << < v >> </pre>
4. Confirm menu item “Adapt filter” and select next menu level	→ soft key	<pre> DEVICE WGH. PARAM. ADAPT FILT oNormal vibration Strong vibration << < v ↓ </pre>
5. Select menu item “Strong vibration”	↓ soft key	<pre> DEVICE WGH. PARAM. ADAPT FILT oNormal vibration Strong vibration << < ^ ↓ </pre>
6. Confirm menu item “Strong vibration”	↓ soft key	<pre> DEVICE WGH. PARAM. ADAPT FILT Normal vibration oStrong vibration << < ^ ↓ </pre>
7. Select other menu items, if desired	↓ ^ soft key(s)	
8. Store the setting and exit Setup menu	←← soft key	

Example 2:
Set time and date

Step	Key (or Instruction)	Display/Printout														
1. Select Setup menu; select "Device parameters"	(SETUP), then ↓ and → soft keys	<table border="1"> <thead> <tr> <th>SETUP</th> <th>DEVICE</th> </tr> </thead> <tbody> <tr> <td>Password</td> <td></td> </tr> <tr> <td>User ID</td> <td></td> </tr> <tr> <td>Weigh. parameters</td> <td></td> </tr> <tr> <td>Interface</td> <td></td> </tr> <tr> <td>Internal printer</td> <td></td> </tr> <tr> <td><<</td> <td>< ↓ ></td> </tr> </tbody> </table>	SETUP	DEVICE	Password		User ID		Weigh. parameters		Interface		Internal printer		<<	< ↓ >
SETUP	DEVICE															
Password																
User ID																
Weigh. parameters																
Interface																
Internal printer																
<<	< ↓ >															
2. Set clock	↓ and → soft keys repeatedly	<table border="1"> <thead> <tr> <th>SETUP</th> <th>DEVICE</th> <th>CLOCK</th> </tr> </thead> <tbody> <tr> <td>Time:</td> <td></td> <td>15.06.10</td> </tr> <tr> <td>Date:</td> <td></td> <td>12.09.97</td> </tr> <tr> <td><<</td> <td>< ↓ ></td> <td></td> </tr> </tbody> </table>	SETUP	DEVICE	CLOCK	Time:		15.06.10	Date:		12.09.97	<<	< ↓ >			
SETUP	DEVICE	CLOCK														
Time:		15.06.10														
Date:		12.09.97														
<<	< ↓ >															
3. Enter the time	(1) (1) (.) (1) (2)	<table border="1"> <thead> <tr> <th>SETUP</th> <th>DEVICE</th> <th>CLOCK</th> </tr> </thead> <tbody> <tr> <td>Time:</td> <td></td> <td>11.12.30</td> </tr> <tr> <td>Date:</td> <td></td> <td>12.09.97</td> </tr> <tr> <td>ESC</td> <td></td> <td>↓</td> </tr> </tbody> </table>	SETUP	DEVICE	CLOCK	Time:		11.12.30	Date:		12.09.97	ESC		↓		
SETUP	DEVICE		CLOCK													
Time:		11.12.30														
Date:		12.09.97														
ESC		↓														
4. Set the time according to your local clock	(.) (3) (0) ↓ soft key															
5. Enter the date	(1) (3) (.) (0) (3)	<table border="1"> <thead> <tr> <th>SETUP</th> <th>DEVICE</th> <th>CLOCK</th> </tr> </thead> <tbody> <tr> <td>Time:</td> <td></td> <td>11.12.42</td> </tr> <tr> <td>Date:</td> <td></td> <td>13.03.99</td> </tr> <tr> <td><<</td> <td>< ↑ ></td> <td></td> </tr> </tbody> </table>	SETUP	DEVICE	CLOCK	Time:		11.12.42	Date:		13.03.99	<<	< ↑ >			
SETUP	DEVICE		CLOCK													
Time:		11.12.42														
Date:		13.03.99														
<<	< ↑ >															
6. Store the date	↓ soft key															
7. Enter other date, if desired	↓ ↑ soft key(s)															
8. Exit Setup menu	<< soft key															

Device Parameters (Overview)

o factory setting

√ user-defined setting

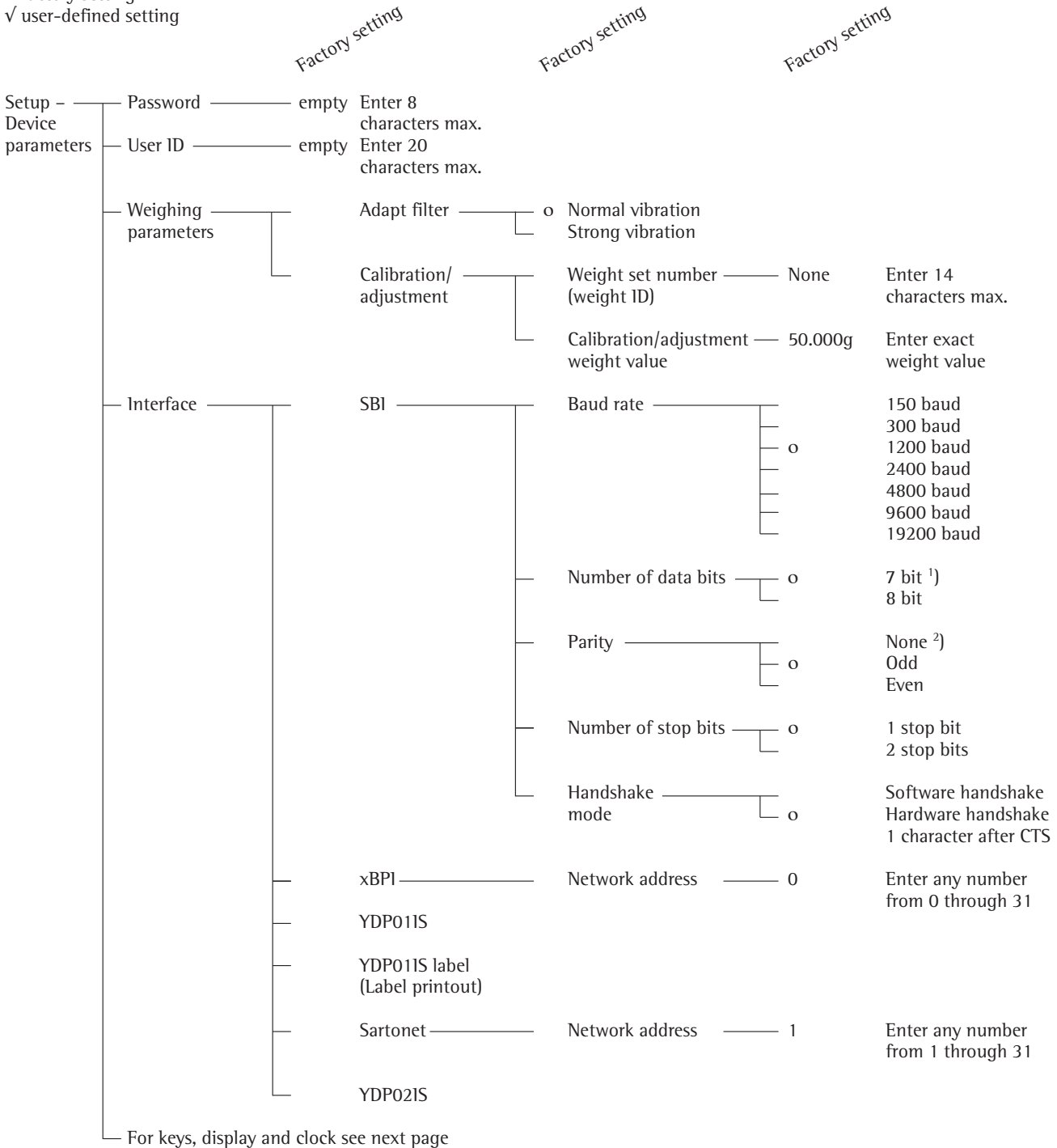

1) not if "None" parity is selected

2) only if 8 data bits selected

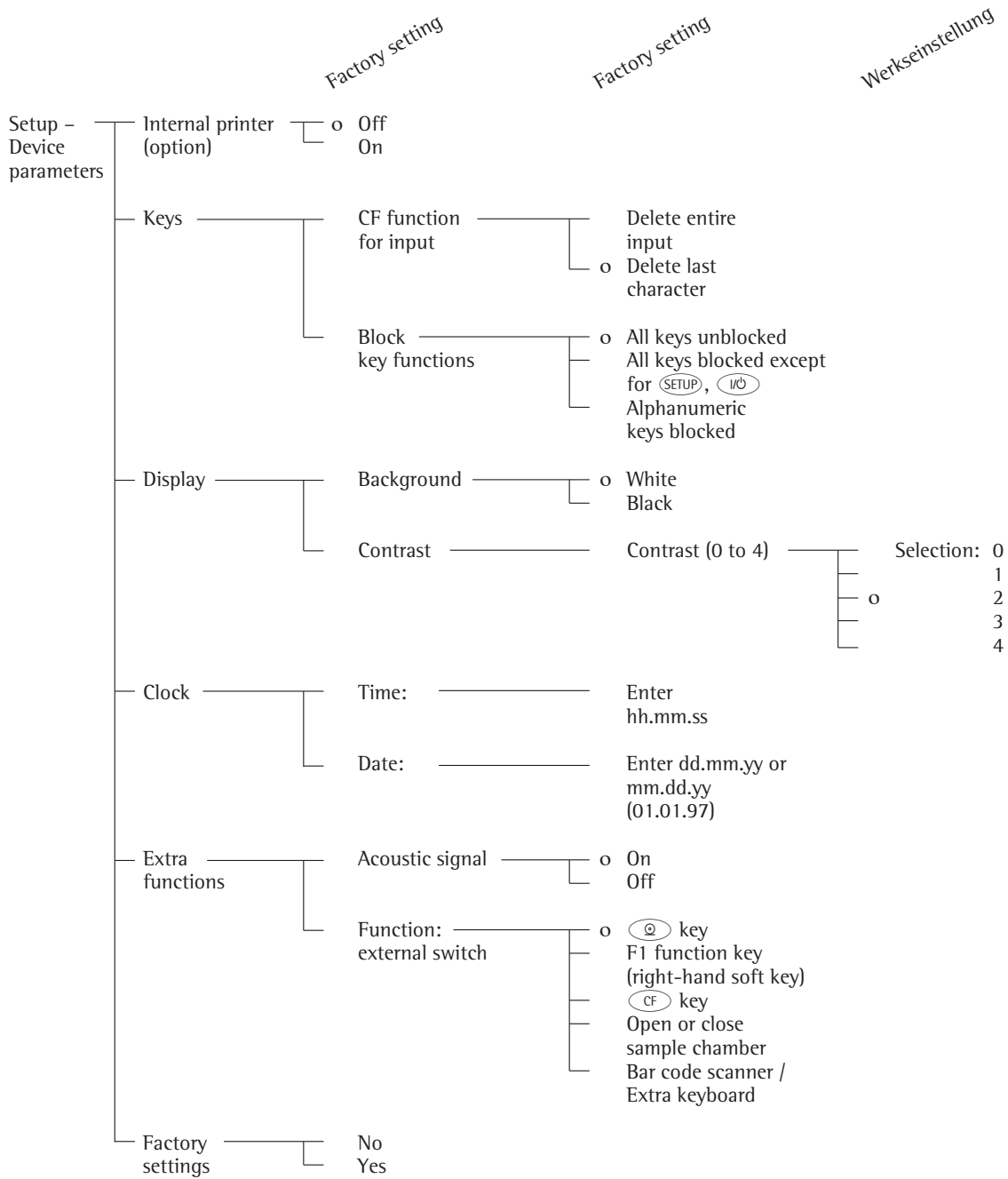

Configuring the Printout (CONFIG)

Purpose

You can configure individual printout formats for each application. All analysis printouts have basic factory settings.

You can block access to the "Printout configuration" data by assigning a password.

Features

- Maximum items in a data record: 30
- Header, footer, intermediate results, statistics and information records can be configured separately
- Printout header is output when starting moisture analysis
- Intermediate records are output during the moisture analysis runs by pressing **Ⓚ** or **Ⓛ** at each printout interval
- Footer printed out at the end of a moisture analysis
- Statistics are printed out while the statistics are displayed by pressing **Ⓚ**:
- Information on phase drying is printed by pressing **Ⓚ** while the information is displayed
- Printout items can be deleted individually

Extra Functions

- Exit "Printout configuration": Press the **⏪** soft key
- > Restart the application

Printout LIST or SELECT

- **LIST**: Output of the current printout list
- **SELECT**: Print currently selectable items

- When the select bar is on **LIST** or **SELECT**: Press **Ⓚ**

- > Printout (example)

```
PRINT HEADER
      LIST
=====
Blank line
GLP header
Program name
Heating param.
Standby temp.
Start parameter
End parameter
Initial weight
-----
=====
```

etc.

Output of All Printout Settings:

- When the select bar is on printout overview (**SETUP CONFIG.**): Press **Ⓚ**

- > Printout (example)

```
-----
13.07.1999      13:08
Mod.           MA100C
Ser. no.       90706913
Ver. no.       01-38-07
ID
```

```
-----
SETUP
      CONFIG.
-----
```

```
Printout header
Blank line
GLP header
Program name
Heating param.
Standby temp.
Start parameter
End parameter
Initial weight
-----
Intermediate result
Analysis time
Analysis result
Printout footer
-----
Ending time
Final weight
Final result
-----
```

etc.

- Reset "Printout Configuration" to the factory settings:
See "Printout configuration"
Set Printouts to Factory Settings and confirm with **YES**.

**Data Items for the Printout:
Parameter**

Parameter	Display text	Print-out header	Inter-mediate result	Print-out footer	Statistics	Info	Printout (Example)
Blank line 1)	Blank line	x*	x	x*	x*	x*	
Dotted line 1)	-----	x*	x	x*	x*	x*	-----
GLP header	GLP header	x*			x*	x*	----- 13.07.1999 13:06 Mod. MA100C Ser. no. 90706913 Ver. no. 01-38-07 ID WORKSTAT 234 -----
GLP footer	GLP footer				x*	x*	13.07.1999 14:06 Name : -----
Date/time	Date/time	x	x	x	x	x	13.07.1999 13:06
Time with seconds	Time	x	x	x	x	x	13:06:45
User ID (from Setup: Device)	User ID	x			x	x	ID WORKSTAT 234
Identification code 1	ID1	x	x	x	x	x	ID1 SARTORIUS
Identification code 2	ID2	x	x	x	x	x	ID2 GOETTINGEN
Identification code 3	ID3	x	x	x	x	x	ID3 WEENDER LANDSTRASSE
Identification code 4	ID4	x	x	x	x	x	ID4 LOT 15
Name in program memory	Program name	x*			x*	x*	Prg 1 BUTTER
Heating program with parameters	Heating param.	x*					Heating STANDARD Fin.temp 105 °C
Standby temperature	Standby temp.	x*					Stdbdy temp. OFF
Start parameter	Start parameter	x*					Start W/STABIL.
End parameter	End parameter	x*					End AUTOMATIC
Preset tare weight	Preset tare	x					PTare 0.000 g
Initial weight	Initial weight	x*					IniWt + 5.712 g
Number of current analysis	Analys no.	x					# 1
Current weight	CurrWt		x				CurrWt+ 5.1357 g
Analysis time according to current display	Analysis time		x		x*		Time 1.0 min
Analysis result according to current display	Analys. res.		x		x*		Res + 0.91 %L
Analysis time and result according to current display	Analys time/res.		x*				1.0 + 0.91 %L
Form feed	Form feed			x			
Space for signature, ID	Name			x	x	x	Name :
Final weight	Final weight			x*			FinWt + 5.1357 g
Time at end of analysis	Ending time			x			Time 15.0 min
Final result according to current display ²⁾	Final result			x			Res + 9.85 %L
Analysis time and result according to current display ²⁾	Final time/res.			x*			15.0 + 9.85 %L
Phase drying intermediate results	Phase results			x		x*	Res1 + 4.45 %L Res2 + 3.15 %L Res3 + 2.25 %L

* Factory setting

1) Print items can be selected more than once

2) "SPRM" result additionally printed at the end of analysis in the "SPRM" mode

SPRM
Difference 1.2 %
Interval 24 sec
or
SPRM
Canceled

Parameter	Display text	Print-out header	Inter-mediate result	Print-out footer	Statistics	Info	Printout (Example)
Text line "Statistics"	Statistics ID				x		STATISTICS
Number of analyses	Number of analys.				x*	n	5
Mean value	Mean value				x*	Avg. +	4.84 %L
Standard deviation	Std. deviation				x*	s	0.05 %L
Minimum	Minimum				x*	Min +	4.80 %L
Maximum	Maximum				x*	Max +	4.90 %L
Text line "ANALYSIS INFO"	Info ID					x*	ANALYS.INFO

* Factory setting

Example:

Adding the Item "Phase Results" to Configure the Printout Footer

Step	Key (or Instruction)	Display/Printout
1. Select Setup menu; Select "Printout configuration"	SETUP , then ↓ soft key twice, then → soft key	<pre> SETUP CONFIG. Printout header Intermediate results printout Printout footer Statistics printout Info printout << < > >> </pre>
2. Select printout footer	↓ soft key twice, then → soft key	<pre> LIST PRT.FOOTER SELECTION ----- Ending time Blank line Final weight Form feed Final result Date/time << Delete < > >> </pre>
3. Use the select bar to define the position for printout items "Phase results" on the LIST	↓ soft key repeatedly	<pre> LIST PRT.FOOTER SELECTION ----- Ending time Blank line Final weight Form feed Final result Date/time << Delete < ^ > >> </pre>
4. Change to Select	→ soft key	<pre> LIST PRT.FOOTER SELECTION ----- Ending time Blank line Final weight Form feed Final result Date/time << < > v >> </pre>
5. Select "Phase results"	↓ soft key repeatedly	<pre> LIST PRT.FOOTER SELECTION ----- Ending time ID3 Final weight ID4 Final result Name << < ^ v >> </pre>
6. Include phase results in the list	↓ soft key	<pre> LIST PRT.FOOTER SELECTION ----- Ending time ID2 Final weight ID3 Final result ID4 Phase results Name << < ^ v >> </pre>
7. Select or delete other printout items, if desired	↓ ^ ^ soft key or ← v ^ Delete soft key(s)	
8. Configure other analysis printouts, if desired	← v ^ → soft key(s)	
9. Exit Setup menu	←← soft key	
10. Perform moisture analysis and press	Q	<pre> ----- Time 15.0 min FinWt + 9.5819 g Res1 + 12.05 %L Res2 + 7.12 %L Res3 + 4.96 %L C-Res + 24.13 %L ----- </pre>

Device Information

Purpose

Display of device information

Display Device Information

- Select Setup menu:
Press the **SETUP** soft key

> "SETUP" is displayed:

SETUP					
Language					
Device parameters					
Printout configuration					
Device information					
<<					>

- Select "INFO: Device information":
Press **↵** soft key three times, then **➤** soft key

> Device information is displayed:

SETUP	INFO				
Versions No:		01-38-07			
Wgh.sys. ver. #:		00-25-03			
Model:		MA100C			
Serial no.:		90805355			
<<		<			

- Printout information:
Press **Ⓚ**

> Printout (example)

```
-----  
13.07.1999      13:02  
Mod.           MA100C  
Ser. no.       90805355  
Ver. no.       01-38-07  
(Operating program version)  
ID             BECKER123  
(User ID)  
-----  
SETUP  
              INFO  
-----  
Versions No:   01-38-07  
(Operating program version)  
Wgh.sys ver.  00-25-03  
(Wgh.sys.program version)  
Model:        MA100C  
Serial no.:   90805355  
-----
```

- Reset to SETUP Overview:
Press the **↶** soft key

- Exit SETUP:
Press the **↶↶** soft key

> Previous status is restored

Operating the Moisture Analyzer

Weighing Function

Purpose

The MA100 moisture analyzer can be used for quick and reliable determination of the moisture content of materials of liquid, pasty and solid substances according to the method of thermogravimetry.

Basics

The moisture of a material is often mistakenly equated with its water content. In fact, the moisture of a material includes of all the volatile components which are given off when the sample is heated, resulting in a decrease in sample weight. Among such volatile substances are:

- water
- fats
- oils
- alcohols
- organic solvents
- flavorings
- products of decomposition (when a sample is overheated)

There are many methods to determine the moisture content of a substance. Basically, these methods can be divided into two categories:

When absolute methods are used, the moisture content is directly determined (for example, as a weight loss registered during the drying routine). These methods include oven drying, infrared drying, and microwave drying. All three of these methods are thermogravimetric.

When deductive methods are used, the moisture content is indirectly determined. A physical property, which is related to the moisture in the substance, is measured (e.g., absorption of electromagnetic rays). These methods include Karl-Fischer titration, infrared spectroscopy, microwave spectroscopy, etc.

Thermogravimetry is the process of determining the loss of mass that occurs when a substance is heated. In this process, the sample is weighed before and after being heated, and the difference between the two weights is calculated.

In a conventional drying oven, circulating hot air warms the sample from the outside to the inside. Efficiency is lost during drying because as the moisture evaporates, it cools the sample surface.

By contrast, infrared rays (IR rays) penetrate a sample without being impeded. Having reached the interior of a sample, they are converted into heat energy, which stimulates evaporation, thus drying the sample. A small part of the IR rays is reflected from the surface of the substance.

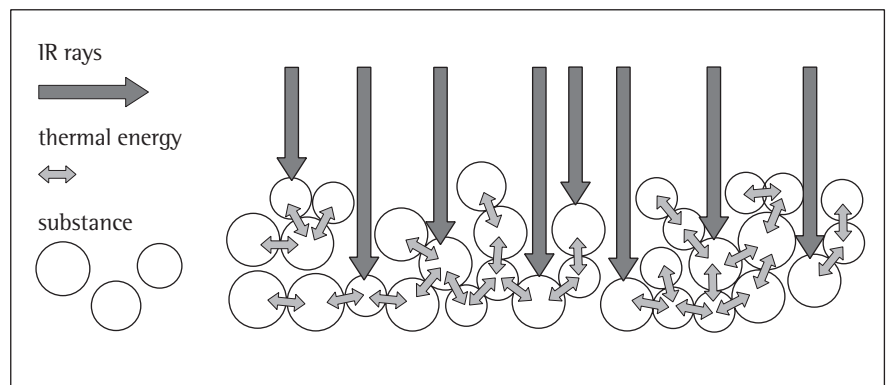

The quantity of reflected IR rays depends to a great extent on whether the substance is light or dark-colored.

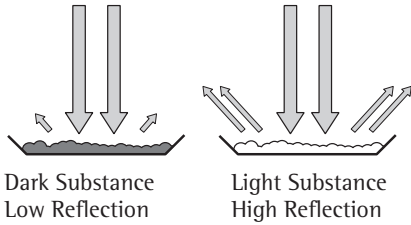

How the rays penetrate the sample depends on the sample's degree of light-transmitting capacity. If the degree of light-transmitting capacity is low, the rays can penetrate only the uppermost layers of the sample. The heat conductivity of the sample dictates the degree to which the heat can be transmitted to the underlying layers. The higher the conductivity, the faster and more uniformly the substance is heated.

The substance should be applied to the sample pan in a thin, even layer. A height of approximately 2 mm – 5 mm for 5 g – 15 g substance weight has proved to be ideal. Otherwise, the sample will not be dried completely or the analysis time will be unnecessarily extended, a crust/skin will form on the surface of the sample or the sample will scorch, and the analysis results obtained will not be reproducible, and therefore, cannot be used.

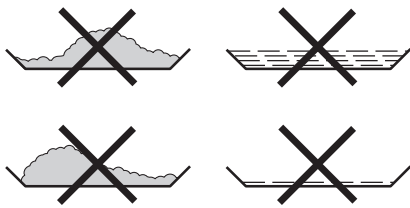

Incorrect Application of a Sample

When preparing a substance for analysis, you should use methods that do not generate heat so that the sample does not lose moisture before it is analyzed.

Perform initial analysis of a new substance to test how the IR rays are absorbed by the sample and converted into heat. The printout of the intermediate values of the drying process provides you with this information at an early stage.

Experience has shown that the temperature setting selected during the infrared drying is usually lower than the temperature setting used when working with a drying oven.

In many cases, the fully automatic shutoff mode will meet your requirements. If the final result is higher or lower than expected, try varying the temperature setting before resorting to a different shutoff parameter.

When analyzing samples that lose their moisture only very slowly or when operating a cold moisture analyzer, the fully automatic mode may end the drying routine too early, if it does not detect any analyzable progress in the drying routine under these conditions. In this case, pre-heat the moisture analyzer for 2–3 minutes before starting the drying routine or select a different shutoff parameter.

The Sartorius Moisture Analyzer Applications Guide will provide you with important information on the use of your moisture analyzer.

Preparation

Before drying a sample, you must carry out the following preparations:

- Adjustment to the available measuring system (if required)
- Sample preparation
- Setting the parameters for drying program

Adjustment to an Existing Measuring System

A moisture analysis method often replaces another drying method (e.g., the oven drying method), because it is simple to use and requires shorter analysis time. In this case, you should adapt this method to that of the moisture analyzer in order to obtain values comparable to those yielded by your standard reference method.

- Perform parallel measurements: take a fresh sample and divide it in half
- Determine the moisture content of the first half using your standard method of analysis
- Analyze the second half of the sample in the moisture analyzer.
Use the following settings:
 - fully automatic mode for the shutoff parameter
 - lower temperature settings than for the oven drying method
 - temperature setting for organic substances: 80 °C – 100 °C
 - temperature setting for inorganic substances: 140 °C – 160 °C
- If the result for the second part does not correspond to that of the first:
 - first, repeat the analysis using a different temperature setting
 - then use the semi-automatic mode for the shutoff parameter (such as 5 mg/30 s or the SPRM mode)

SPRM stands for “**S**wift **P**arameter **A**adjustment to a **G**iven **R**eference **M**ethod”. The SPRM mode monitors the drying process and, at the press of a key, calculates a semi-automatic shutoff parameter for the expected results of the analysis. It then saves the parameter in a program routine.

- Vary the shutoff parameter, if required:
 - Increase end-point recognition: set the parameter to 2 mg/30 s or 5 mg/60 s
 - Decrease end-point recognition: set the parameter to 10 mg/30 s or 5 mg/10 s

Preparing a Sample

Selecting a Sample

- Select a representative part of the whole substance as a sample
 - a representative number of individual samples for quality control
 - samples which indicate a trend are sufficient for in-process control
- Homogenize the product before a sample is taken, if required, by:
 - mixing or stirring
 - taking several samples from different areas of the product
 - taking several samples at defined intervals
- Take only one sample at a time for a given analysis and prepare it as quickly as possible. In this way, it will not lose or gain moisture as a result of the ambient conditions.
- If you need to analyze several samples at a time, the samples must be sealed in air-tight containers, in order to be sure that the storage conditions do not alter the state or condition of the samples:
 - Warm or highly volatile substances lose their moisture very quickly.
 - If you store the samples in a container, the moisture can condense on the walls of the container.
 - If the container is too big and not filled completely, the sample can exchange its moisture with the air remaining in the container.
- Mix condensed moisture back in with a sample, if necessary.

Preparing a Sample

- When crushing a sample, avoid any contact with heat: heat results in moisture loss.
- Crush a sample with
 - a pestle
 - a shredder (see below)

For liquids containing solids, use

 - a glass stirrer
 - a spoon or
 - a magnetic stirrer.
- Use an appropriately designed tool for shredding a sample.

Using Disposable Sample Pans

- Use only Sartorius disposable sample pans (inner diameter = 92 mm). Reusing sample pans leads to poor reproducibility of results:
 - after cleaning, sample residues can still remain on the pan
 - residues from cleaning agents can evaporate during the next moisture analysis
 - scratches and grooves inflicted during cleaning provide surfaces on which the rising hot air produced during the drying process can act, resulting in a more pronounced buoyancy

Applying a Sample to the Sample Pan

- Apply the sample to the sample pan in a thin, even layer (height: 2 mm to 5 mm, weight: 5 g to 15 g); otherwise:
 - a sample applied unevenly will result in a nonuniform distribution of heat
 - a sample will not be dried completely
 - the analysis time will be unnecessarily extended
 - the sample burns or a crust/ skin forms on its surface as a result of a very thick layer
 - the crust makes it difficult or impossible for moisture to escape from the sample during the drying process
 - uncertain and unknown quantity of moisture remains in the sample

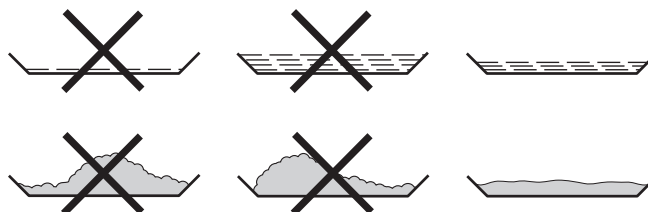

- Apply liquid samples, pasty samples or samples that can melt to a glass fiber filter (order no. 6906940); you will obtain the following advantages:
 - uniform distribution due to the capillary effect
 - prevents liquids from beading together and forming drops
 - with larger surfaces, the moisture can evaporate faster
 - considerably more convenient than the “sea-sand method”

When drying samples containing sugar, a crust or skin can form and seal the surface. A glass fiber filter is especially helpful in such cases. The moisture can evaporate downwards through the surface of the filter. You can avoid or limit the crust/skin formation if you place the glass fiber filter on top of the sample.

- Cover solid, heat-sensitive samples with a glass fiber filter (order no. 6906940); you will obtain the following advantages:
 - gentle heating, because the sample surface is shielded from excessive heat
 - higher temperature setting can be selected
 - uniformity of the sample surface
 - fast evaporation of the moisture
 - excellent reproducibility for samples containing fat

Avoiding the Formation of Crust/Skin

You can add solvents to the sample to prevent the formation of crust/skin during the analysis runs. The weight of a solvent you apply to the sample will not influence the final result of an analysis.

- Once you have closed the sample chamber, open it again within 2 seconds after you hear a beep tone.
- Apply a solvent to the sample
- Close the sample chamber and start the analysis run as usual

Setting the Drying Parameters

Purpose
Adapt the moisture analyzer to the special requirements of products.
Parameters can be configured individually for every program.

Drying Parameters (Overview)

- o Factory setting
- √ User-defined setting

		Factory setting			Factory setting	
Program memory (P r o g r .)	Program name	None				
	Heating program	o Standard drying	105 °C	30 °C to 200 °C for MA100Q, otherwise 30 °C to 180 °C		
		Quick drying	105 °C	30 °C to 200 °C for MA100Q, otherwise 30 °C to 180 °C		
		Gentle drying	Temperature:	105 °C	30 °C to 200 °C for MA100Q, otherwise 30 °C to 180 °C,	
			Time:	3.0 min.	1.0 to 20 minutes	
		Phase drying	Temperature 1:	80 °C	30 °C to 200 °C for MA100Q, otherwise 30 °C to 180 °C,	
	Time 1:		5.0 min.	0.0 to 99.9 minutes		
	Temperature 2:		105 °C	2nd phase: 30 °C to 200 °C for MA100Q,		
	Time 2:		5.0 min.	otherwise 30 °C to 200 °C, 0.0 to 99.9 minutes		
	Temperature 3:		120 °C	3rd phase: 30 °C to 200 °C for MA100Q,		
	High-temperature drying	105 °C	30 °C to 230 °C only for MA100Q			
	Standby temperature	o Off				
		On	Temperature:	40 °C	30 °C to 100 °C	
	Initial weight	o Off				
		Minimum and maximum initial weight	Max. init.wt.:	5 g	1 mg to 90 % of max. capacity	
Min. init.wt.:			1 g	1 mg to 90 % of max. capacity		
Target weight Tolerance in %		Target weight:	5 g	2 mg to 90 % of max. capacity		
	Tolerance:	10 %	1 % to 50 %			
Start analysis	o With stability + auto close	Time delay:	2 sec.	0 to 99 seconds		
	With stability, manual close	Time delay:	2 sec.	0 to 99 seconds		
	Without stability, auto close	Time delay:	2 sec.	0 to 99 seconds		
	Without stability, manual close	Time delay:	2 sec.	0 to 99 seconds		
	Fully automatic, With stability	No time delay				
	Fully automatic, Without stability	No time delay				
End of analysis	o Fully automatic SPRM: determ.-semi-auto parameters					
	Semi-auto: absolute weight loss	Loss:	10 mg	1 to 50 mg		
		Time interval:	60 sec.	5 to 300 seconds		
	Semi-auto: weight loss in percent	Loss:	1.0 %	0.1 to 50 %		
		Time interval:	60 sec.	5 to 300 seconds		
Time	Time:	15.0 min.	0.1 to 999.9 minutes			
Manual						

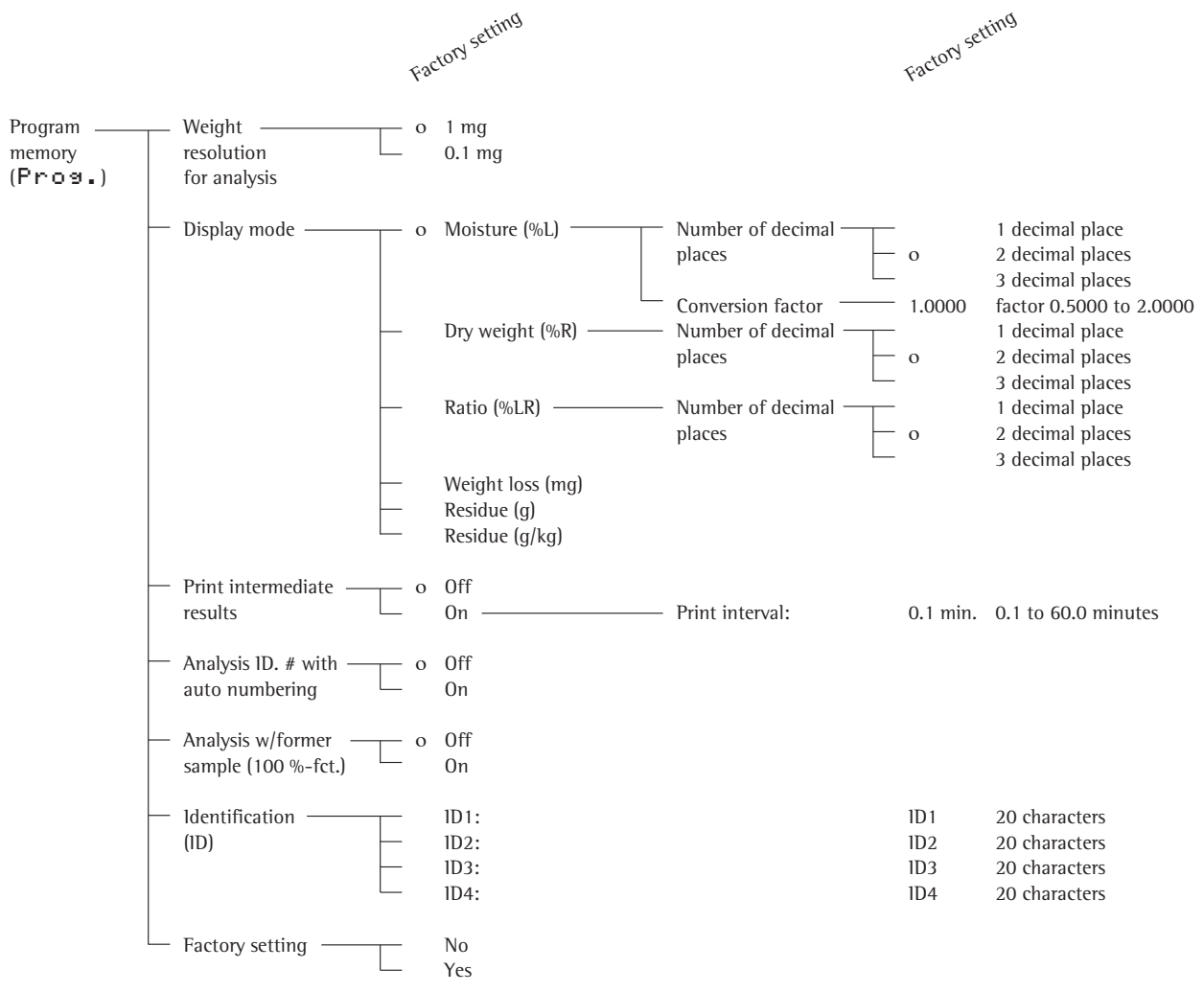

Features

Number of Drying Programs

30 programs

Individual names with a maximum of 15 characters as user identification in program selection and for the moisture analysis printouts

All programs are listed according to the program number.

Heating Programs

To perform a moisture analysis of a substance, you can choose among four heating programs:

- Standard drying
- Quick drying
- Gentle drying
- Phase drying
- High-temperature drying
Only for MA 100Q models

Standard drying:

For the standard program, you need to enter the final temperature.

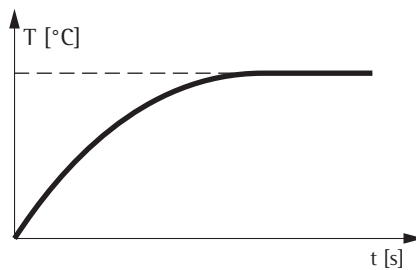

Quick drying:

For quick drying, you need to enter the final temperature. The heat output is higher.

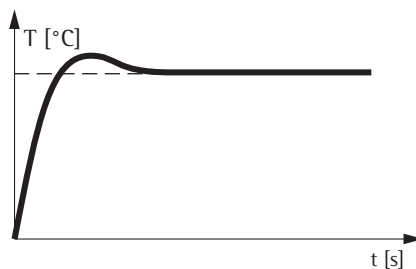

Gentle drying:

For gentle drying, you need to enter the final temperature and time required to achieve the final temperature.

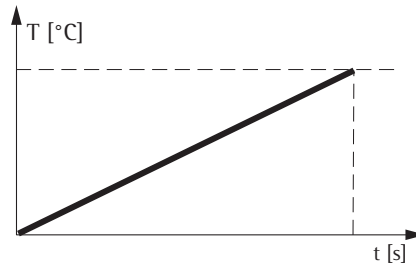

Phase drying:

Phase drying comprises three drying phases. You need to enter the temperature for each phase, including the time for the first and second drying phases. The shutoff parameters will be activated only in the 3rd phase.

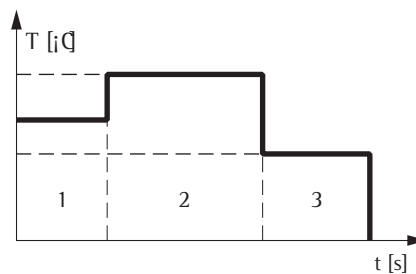

High-temperature drying:

- For temperatures ≤ 200 °C as for standard drying
- For temperatures > 200 °C: heating up to selected temperature as for gentle drying
 - From the 10th to the 30th minute: Nominal temperature in 5 levels up to 200 °C

Standby Temperature

- Temperature set to defined value when the sample chamber is closed

Weighing-in

You can enter the weight limits for the initial weight of your sample (minimum and maximum or target weight with tolerance in percent)

Start of Analysis

- Confirm initial weight with or without stability after pressing the **Start** soft key (time delay: MA100: selectable)
- With "Manual or automatic close" for the sample chamber (By pressing the **Start** soft key; time delay: MA100: selectable)
- Fully automatic control: For remote control of an analysis using the universal remote control switch (F1 key functions: Tare, Start, Next)
 - close the sample chamber
 - with or without stability
 - time delay: 0 seconds
 - open after the analyzer is activated or after pressing the **Next** soft key
 - close after pressing the **Tare** soft key
 - open after taring

For using time delay: open the sample chamber during the selected time delay to apply the solvents

End of Analysis with Shutoff Parameters

- fully automatic mode
- SPRM mode: parameter determination for semi-automatic mode
- semi-automatic, absolute
- semi-automatic, in percent
- time
- manual

Fully Automatic Mode:

The fully automatic mode can be used if the loss of weight on drying follows a clearly defined curve (see below).

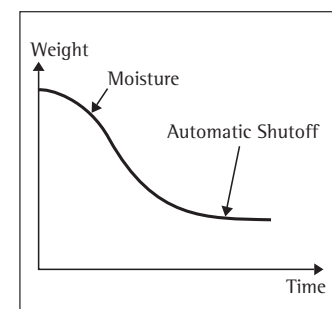

SPRM

(Swift Parameter Adjustment to a Given Reference Method): parameter determination for semi-automatic mode

Automatic parameter determination for shutoff criterion; semi-automatic; percentual. In this case, you need to press the **Stop** key to end an analysis; the weight loss rate will then be calculated and saved as a drying parameter.

Semi-automatic, absolute:

The analysis ends as soon as the weight loss of a selectable time unit is less than the defined limit, which can be selected in milligrams. You will need to enter the time unit and the weight loss.

Semi-automatic, in percent:

The analysis ends as soon as the weight loss during a specified time period is less than the defined limit, which can be selected in percent of the initial weight. You will need to enter the time unit and the weight loss with reference to the initial weight.

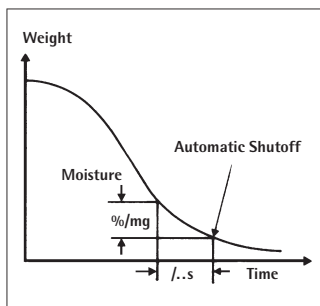

Time:

The analysis ends as soon as the entered time has elapsed.

Manual:

You must press the **Stop** key to end an analysis.

Weight Resolution for Analysis

You can select the number of decimal places to be displayed for the weight resolution:

- increased weight resolution during the drying process only
- output on the display and in the printout

Display Mode

The following units can be selected for displaying analysis results:

- Moisture %L
decimal places, selectable
(with conversion factor)
- Dry weight %R
decimal places, selectable
- Ratio %LR
decimal places, selectable
- Weight loss mg
- Residue g
- Residue g/kg

Intermediate Results Printout

Intermediate results can be printed either at user-definable time intervals or by pressing the **Q** key.

Analysis Number for Automatic Consecutive Counting

- The analysis number can be counted automatically for all analyses performed in sequence:
- Press the **Next** soft key to save this number
- The number is set to 1 automatically each time the analyzer is activated
- Numbers are printed out in the header for each analysis

Analysis with Former Sample (100 % function)

The sample weight of the last analysis is calculated as 100 % for the next analysis

4 Identification Codes (IDs)

Identification codes can be entered for each drying program (such as Dairy Farm, Berlin, powdered milk, Lot 1):

- For user-defined printouts
- Maximum of 20 characters for the "Name" of 4 identification codes (first part)
- The related values (last part) can be entered after pressing the **ID** soft key during the analysis runs

Factory Settings

The drying programs can be reset to the factory settings.

Searching for Programs

In the program memory (after pressing the **Prog.** soft key):

- Soft key **v** and **^**
- Enter the desired program number and press the **Number** soft key
- Enter the first or all characters of the desired program number and press the **Name** soft key
- Statistics included

Before activating the function "TARE: Tare the sample pan":

- Enter the desired program number and press the **Prog.** soft key

- Printout of the Analysis Parameters**
- When the desired program is displayed: Press the **Ⓚ** key
 - > Printout (see example on the right)
Texts with more than 20 characters are truncated.

Extra Functions

The following functions are available in the program memory:

- Display programs
- Change the settings
- Copy or rewrite the programs by pressing the **Copy** soft key
- Load the programs by pressing the **Load** soft key
- Print out the list with program numbers and names

```

-----
13.07.1999      13:06
Mod             MA100C
Ser. no.       90706913
Ver. no.       01-38-07
ID
-----
SETUP
      ANALYSIS
-----
Prg.            1
-----
Program name
Program name:   RYE
Heating program
Standard drying
Temperature:    105 'C
Standby temperature
                Off
Bar graph for weigh
                Inactivated
Start of analysis
With stability + a
Time delay:    2 sec
End of analysis
                Fully automatic
Weight resolution f
                1 mg
Display mode
Moisture        (%)
Number of decimal
                2 decimal places
Conversion factor
Factor:         1.0000
Print intermediate
                Off
Analysis ID # with
                No
Analysis w/formers
                No
Identification #
ID1:
                COMPANY:
ID2:
                CITY:
ID3:
                LOT:
ID4:
                NAME:
-----

```

Function Keys (Soft Keys)

- Info** Intermediate results for phase drying
- Prog.** Parameter setting for drying programs
- Stat.** Statistics on the analyses of the selected drying program
- ID** Data input for 4 identification codes (IDs)
- Mode** Parameter settings: "Decimal places," "Weighing result," "Display mode," "Intermediate results printout"
- Tare** Tare sample pan
- Load** Load the selected drying program as the current program
- Copy** Store the current parameter settings in the selected program location

Displaying Analysis Data

Overview

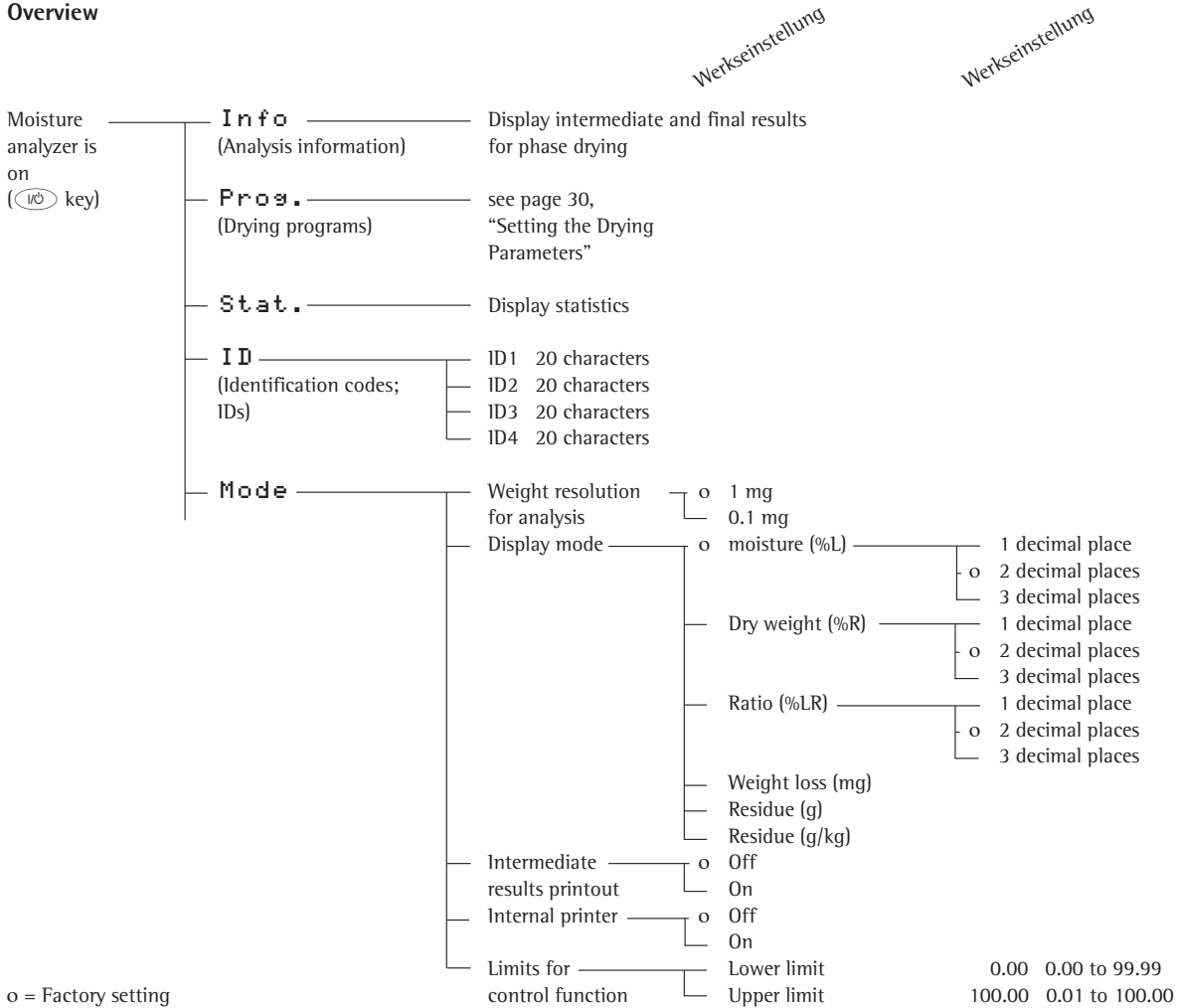

o = Factory setting

Identification Codes (IDs)

You can use codes to identify current analyses, and can enter 4 IDs for each analysis.

Every ID consists of a generic name and a specific name, both of which are user-definable. The generic ID name (left part) is normally a proper name and can be entered during the respective drying program (such as the company, city, etc.). The specific ID names are entered for the current analysis and exist only once.

Features:

Enter, change and delete function for all 4 IDs (ID soft key)

Enter the first identification code (ID1) directly using the numeric keys

Maximum of 20 characters for every generic ID name

Maximum of 20 characters for every specific ID name

Each ID is printed once in any place on the printout.

The generic name printout is left-justified; the specific name printout, right-justified. A specific name is printed in the next line if the generic and specific names exceed the character line limit. The identification line is skipped if generic and specific names contain no characters at all.

ID	
COMPANY:	DAIRY FARM
CITY:	BERLIN
LOT:	POWDERED MILK NO 105
NAME:	JOHN MEYER
<<	>>

Entering Specific ID Names

```

-----
COMPANY:  DAIRY FARM
CITY:      BERLIN
LOT:
POWDERED MILK NO 105
NAME:      JOHN MEYER
-----
    
```

ID line printout

Mode

Parameters listed in the overview (see previous page) under the **Mode** item can be temporarily changed. Each time the moisture analyzer is turned on and off or after parameters are changed in the Program or Setup menu, the temporarily changed parameters are deleted and overwritten by the parameters of the currently loaded drying program (exception: Limits for control function).

Features:

Display parameters

Change parameters

MODE				
Weight resolution for analysis				
Display mode				
Print intermediate results				
Internal printer				
Limits for control function				
<<				>

Info

During the drying program with phase drying as the heating program, intermediate results of the drying phases can be displayed after the respective analysis time has elapsed. The final result is displayed at the end of the analysis.

Features:

Displays drying phases including time and moisture loss

Displays final results at the end of analysis

If the display mode is set to weight loss (mg), values are displayed in mg; otherwise, as moisture (%L)

INFO				
1:	2.0min	Res1 +	2.00 %L	
2:	3.0min	Res2 +	5.54 %L	
3:	4.0min			

<<				>

Displays information on an analysis run after drying phase 2

Example for Mode: Temporarily Changing the Unit for the Display Mode

You can temporarily change the unit for the display mode.

- Select **MODE**: Press the **Mode** soft key
- Select **Display mode**: Press the **↵** soft key
- Confirm **Display mode**: Press the **➤** soft key
- > Display mode appears
- Select the desired unit: Press the **↵** soft key repeatedly
- Confirm the desired unit: Press the **➤** soft key
- > Decimal places are displayed
- Select the number of decimal places: Press the **↵** soft key repeatedly
- Confirm the number of decimal places: Press the **↵** soft key
- Exit **MODE**: Press the **<<** soft key

Statistics

Statistics are listed for each drying program. The following values can be displayed:

- Last analysis result
- Last analysis time
- Number of analyses
- Average (mean value)
- Standard deviation
- Lowest value (minimum)
- Highest value (maximum)

Features:

Statistics on the moisture analysis results for up to 9999 analyses

Statistics stored as a part of the data record for moisture analysis parameters

Update at the end of analysis routine

No update after 10,000 analyses, analysis cancel, analysis with former sample (100 % function), at the end of a SPRM analysis

Delete the last analysis result by pressing the **M-** soft key

Delete the statistics data with the

Delete soft key after you are prompted for confirmation

Use-defined printout of statistics data by using the **⓪** key

PROG. 1		STATISTICS		
Last Result	Res +	16.30	%L	
Last time	Time	1.8	min	
No. of analys.	n	3		
Mean value	Avg. +	16.42	%L	
Std. deviation	s	0.22	%L	
<<	Delete			>

Display of statistics data

```

-----
                        STATISTICS
-----
Prg 1                                1
-----
Res +      7.411 %L
Time      4.3 min
n          2
Avg. +    8.705 %L
s         1.830 %L
Min +     7.411 %L
Max +     9.999 %L
-----

```

Display of statistics (also available with GLP header and footer)

Example 1: Standard Drying with Fully Automatic Shutoff Mode

The moisture content of 2 g of corn starch is to be analyzed. The sample can scorch if overheated, but it is not overly heat sensitive. The analysis is to be ended automatically as soon as a constant weight is reached.







Settings (factory setting):

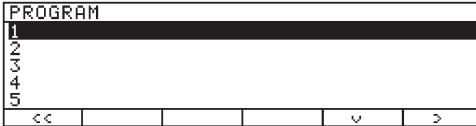
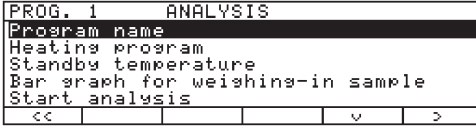
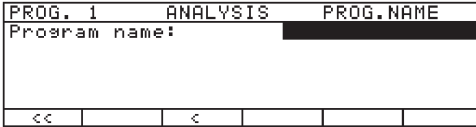

Program number: 1

Program name: corn starch

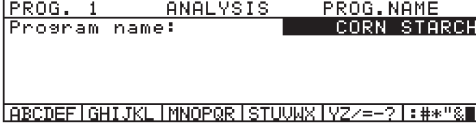
Final temperature: 130 °C

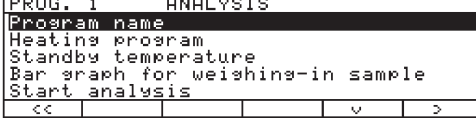
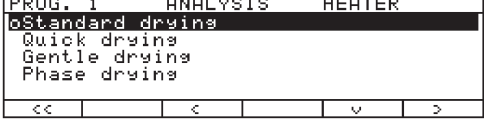
End of analysis: automatic (different from the factory settings)

Step	Key (or instruction)	Display/Printout
1. Turn on the moisture analyzer	 key	Sartorius logo is displayed Self-test runs
2. Enter the parameters for drying program	Prog. soft key	
3. Select program "1"	> soft key	
4. Select "Program name"	> soft key	
5. Enter the program name (e.g., corn starch)	  ...  keys ABCDEF ... soft keys A B C D ... soft keys	
6. Confirm your input and exit the program	 key ↓ soft key < soft key	
7. Select the heating program	↓ soft key > soft key	

Step	Keys (or instruction)	Display/Printout																																				
8. Select "Standard drying" program	➤ soft key	<table border="1"> <tr> <td>PROG. 1</td> <td>HEATER</td> <td>STANDARD</td> <td></td> <td></td> <td></td> </tr> <tr> <td colspan="2">Temperature:</td> <td>105 °C</td> <td></td> <td></td> <td></td> </tr> <tr> <td><<</td> <td><</td> <td></td> <td></td> <td></td> <td></td> </tr> </table>	PROG. 1	HEATER	STANDARD				Temperature:		105 °C				<<	<																						
PROG. 1	HEATER	STANDARD																																				
Temperature:		105 °C																																				
<<	<																																					
9. Enter new final temperature (in this case: 130 °C)	① ③ ① soft keys	<table border="1"> <tr> <td>PROG. 1</td> <td>HEATER</td> <td>STANDARD</td> <td></td> <td></td> <td></td> </tr> <tr> <td colspan="2">Temperature:</td> <td>130 °C</td> <td></td> <td></td> <td></td> </tr> <tr> <td>ESC</td> <td></td> <td></td> <td></td> <td></td> <td>↓</td> </tr> </table>	PROG. 1	HEATER	STANDARD				Temperature:		130 °C				ESC					↓																		
PROG. 1	HEATER	STANDARD																																				
Temperature:		130 °C																																				
ESC					↓																																	
10. Confirm the temperature and exit the input mode	↓ soft key ← soft key	<table border="1"> <tr> <td>PROG. 1</td> <td>ANALYSIS</td> <td>HEATER</td> <td></td> <td></td> <td></td> </tr> <tr> <td colspan="2">Standard drying</td> <td></td> <td></td> <td></td> <td></td> </tr> <tr> <td colspan="2">Quick drying</td> <td></td> <td></td> <td></td> <td></td> </tr> <tr> <td colspan="2">Gentle drying</td> <td></td> <td></td> <td></td> <td></td> </tr> <tr> <td colspan="2">Phase drying</td> <td></td> <td></td> <td></td> <td></td> </tr> <tr> <td><<</td> <td><</td> <td></td> <td>v</td> <td></td> <td>></td> </tr> </table>	PROG. 1	ANALYSIS	HEATER				Standard drying						Quick drying						Gentle drying						Phase drying						<<	<		v		>
PROG. 1	ANALYSIS	HEATER																																				
Standard drying																																						
Quick drying																																						
Gentle drying																																						
Phase drying																																						
<<	<		v		>																																	
11. Exit input mode for drying parameters	←← soft key twice	<table border="1"> <tr> <td>P1</td> <td>130°C</td> <td>Auto.</td> <td></td> <td></td> <td></td> </tr> <tr> <td colspan="2">+</td> <td>0.035 g</td> <td></td> <td></td> <td></td> </tr> <tr> <td colspan="2">TARE: Tare sample pan</td> <td></td> <td></td> <td></td> <td></td> </tr> <tr> <td></td> <td>Prog.</td> <td>Stat.</td> <td>ID</td> <td>Mode</td> <td>Tare</td> </tr> </table>	P1	130°C	Auto.				+		0.035 g				TARE: Tare sample pan							Prog.	Stat.	ID	Mode	Tare												
P1	130°C	Auto.																																				
+		0.035 g																																				
TARE: Tare sample pan																																						
	Prog.	Stat.	ID	Mode	Tare																																	
12. Prepare the sample: not necessary for corn starch																																						
13. Open the sample chamber Position the new sample pan	⏴ key 																																					
14. Tare the sample pan	Tare soft key	<table border="1"> <tr> <td>P1</td> <td>130°C</td> <td>Auto.</td> <td></td> <td></td> <td></td> </tr> <tr> <td colspan="2">0.000 g</td> <td></td> <td></td> <td></td> <td></td> </tr> <tr> <td colspan="2">WEIGH-IN: Load sample</td> <td></td> <td></td> <td></td> <td></td> </tr> <tr> <td></td> <td>Stat.</td> <td>ID</td> <td>Mode</td> <td></td> <td></td> </tr> </table>	P1	130°C	Auto.				0.000 g						WEIGH-IN: Load sample							Stat.	ID	Mode														
P1	130°C	Auto.																																				
0.000 g																																						
WEIGH-IN: Load sample																																						
	Stat.	ID	Mode																																			
15. Spread approx. 2 g of corn starch uniformly on the sample pan Close the sample chamber	 ⏴ key	<table border="1"> <tr> <td>P1</td> <td>130°C</td> <td>Auto.</td> <td></td> <td></td> <td></td> </tr> <tr> <td colspan="2">+ 2.036 g</td> <td></td> <td></td> <td></td> <td></td> </tr> <tr> <td colspan="2">WEIGH-IN: Start analysis</td> <td></td> <td></td> <td></td> <td></td> </tr> <tr> <td></td> <td>Stat.</td> <td>ID</td> <td>Mode</td> <td>Start</td> <td></td> </tr> </table>	P1	130°C	Auto.				+ 2.036 g						WEIGH-IN: Start analysis							Stat.	ID	Mode	Start													
P1	130°C	Auto.																																				
+ 2.036 g																																						
WEIGH-IN: Start analysis																																						
	Stat.	ID	Mode	Start																																		
16. Start the drying program	Start soft key	<table border="1"> <tr> <td>P1</td> <td>130°C</td> <td>Auto.</td> <td></td> <td></td> <td></td> </tr> <tr> <td colspan="2">+ 2.036 g</td> <td></td> <td></td> <td></td> <td></td> </tr> <tr> <td colspan="2">ANALYS. BEGIN: Delay start 2 sec</td> <td></td> <td></td> <td></td> <td></td> </tr> <tr> <td></td> <td></td> <td></td> <td></td> <td></td> <td></td> </tr> </table>	P1	130°C	Auto.				+ 2.036 g						ANALYS. BEGIN: Delay start 2 sec																							
P1	130°C	Auto.																																				
+ 2.036 g																																						
ANALYS. BEGIN: Delay start 2 sec																																						
After 2 seconds' delay the header for the moisture analysis is printed	see next page																																					

Step	Key (or instruction)	Display/Printout
The header for the moisture analysis is printed		<pre> P1 130°C Auto. + 2.036 g ANALYS.BEGIN: Mode Cancel ----- 14.07.1999 13:10 Mod. MA100C Ser. no. 90805355 Ver. no. 01-38-07 ID ----- Prg 1 CORN STARCH Heating STANDARD Fin. temp. 130 'C Stdby temp. OFF Start W/STABIL. End AUTOMATIC IniWt + 2.036 g ----- </pre>
The current moisture loss is displayed afterwards		<pre> P1 130°C Auto. + 0.05 %L ANALYSIS: 37°C 0.8min ---ms/24s Mode Cancel </pre>
17. Set the display mode to dry weight display	Mode soft key	<pre> MODE Weight resolution for analysis Display mode Print intermediate results Internal printer Limits for control function << < > >> </pre>
18. Select display mode and confirm	v soft key > soft key	<pre> MODE DISPL. MODE Moisture (%L) Dry weight (%R) Ratio (%LR) Weight loss (ms) Residue (g) << < > >> </pre>
19. Select dry weight and confirm	v soft key > soft key	<pre> MODE DISPL. MODE DRY WEIGHT 1 decimal place 2 decimal places 3 decimal places << < > >> </pre>
20. Leave decimal places unchanged	< soft key	<pre> MODE DISPL. MODE Moisture (%L) Dry weight (%R) Ratio (%LR) Weight loss (ms) Residue (g) << < > >> </pre>

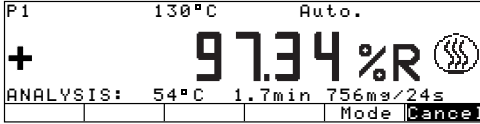
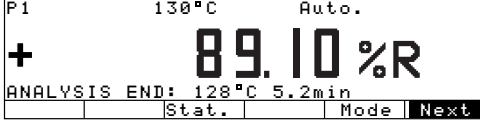



Step	Key (or instruction)	Display/Printout
21. Exit the parameter display The residual dry weight is displayed as a percentage of the initial weight	<< soft key	
Fully automatic shutoff of the drying process, if no further weight loss is registered (in this case: after 5.2 minutes)		
The footer for the moisture analysis is printed		<pre> ----- Analys.Time 5.2 min FinWt + 1.814 g Res + 89.10 %R ----- </pre>



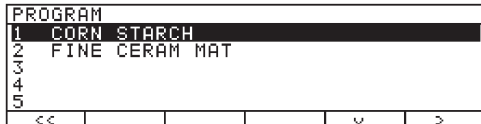
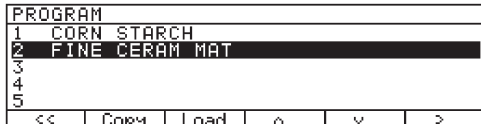
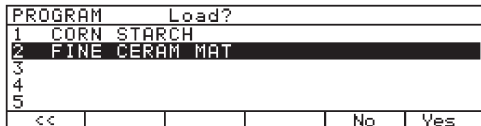

Example 2: Quick Drying with Fully Automatic Shutoff Mode

The moisture content of 2.5 g of fine ceramic material is to be determined. This non-heat-sensitive sample is to be analyzed as soon quickly possible. The analysis is to be ended automatically as soon as a constant weight is reached.

Settings (factory setting):

- Program number: 2
- Program name: fine ceramic material
- Heating program: quick drying
- Final temperature: 200 °C
- End of analysis: automatic (different from the factory settings)
- Result displayed: dry weight (%R)

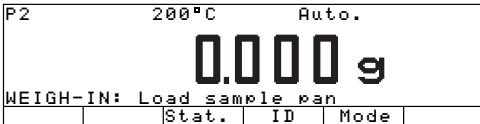
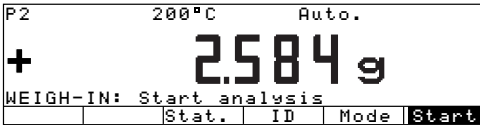
Step	Key (or instruction)	Display/Printout
1. Turn on the moisture analyzer	 key	Sartorius logo is displayed Self-test runs
The above mentioned parameters for drying program 2 “fine ceramic material” have already been set	Enter the parameters: see Example 1	
2. Select program display	Prog. soft key	
3. Select program “2”	v soft key	
4. Load program “fine ceramic material” as the current drying program	Load soft key	
5. Confirm load prompt	Yes soft key	
6. Prepare the sample: Cut the fine ceramic material into thin slices		

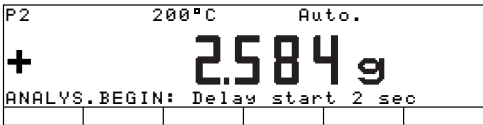
Step	Key (or instruction)	Display/Printout
7. Open the sample chamber Position a new sample pan	 key 	
8. Tare the sample pan	Tare soft key	
9. Distribute approx. 2.5 g of on the sample pan Close the sample chamber	  key	
10. Start the drying program	Start soft key	

After 2 seconds' delay,
the header for the moisture
analysis will be printed

```
-----
14.07.1999      14:10
Mod.            MA100C
Ser. no.       90805355
Ver. no.       01-38-07
ID
```

```
-----
Prg 2 FINE CERAM MAT
Heating        QUICK
Fin. temp.    200 'C
Stdbby temp.  OFF
Start         W/STABIL.
End          AUTOMATIC
IniWt +      2.584 g
```

The current moisture loss
will be displayed afterwards

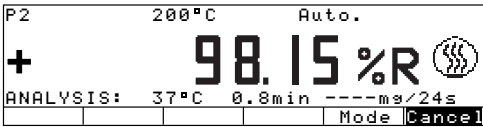

Fully automatic shutoff of the
drying process, if no further
weight loss is registered
(in this case: after 9 minutes)

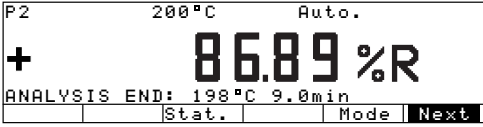

The footer for the moisture
analysis is printed



```
-----
Analys. Time  9.0 min
FinWt +      2.246 g
Res +        86.89 %R
SPRM
Difference    1.2 %
Interval     24 sec
-----
```



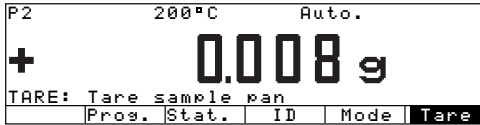
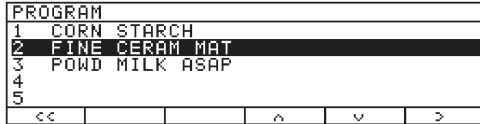
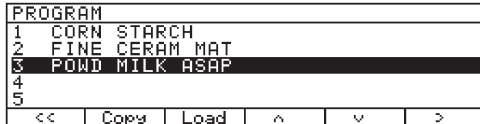
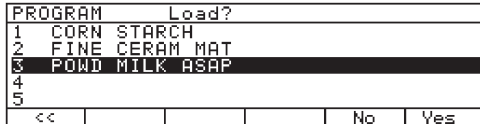
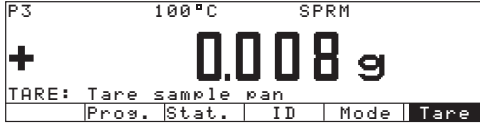

Example 3: Gentle Drying Using “SPRM” to Determine the Shutoff Criteria

The moisture content of 45 g of powdered skim milk is to be determined. This especially heat sensitive sample is to be heated slowly in order to avoid scorch on the sample surface. The analysis is to be finished via SPRM (Swift Parameter Adjustment to a Given Reference Method) as soon as the final temperature is reached.

Settings (deviations from the factory setting):

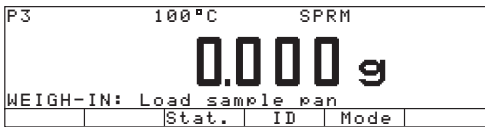
- Program number: 3
- Program name: powdered skim milk SPRM (powd milk SPRM)
- Heating program: gentle drying
- Final temperature: 100 °C
- Heating time: 5 minutes
- End of analysis: SPRM: parameter determination for semi-automatic mode

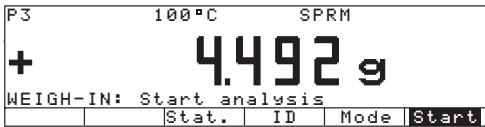
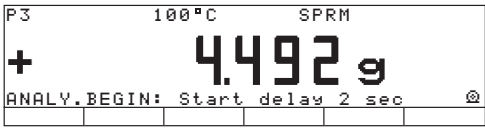
Step	Key (or instruction)	Display/Printout
1. Turn on the moisture analyzer	 key	Sartorius logo is displayed Self-test runs
The above mentioned parameters for drying program 3 “powdered skim milk SPRM” have already been set	Enter the parameters: see Example 1	
2. Select program display	Prog. soft key	
3. Select program “3”	↵ soft key	
4. Load program “powd milk SPRM” as the current drying program	Load soft key	
5. Confirm load prompt	Yes soft key	
6. Prepare the sample: not necessary for powdered skim milk		
7. Open the sample chamber	 key	
Position a new sample pan		

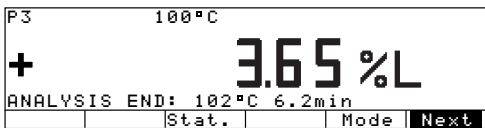
Step	Key (or instruction)	Display/Printout
8. Tare the sample pan	Tare soft key	
9. Spread an even layer skim milk on the sample pan Close the sample chamber	  key	
10. Start the drying program	Start soft key	
After 2 seconds' delay the header for the moisture analysis is printed		<pre> ----- 14.07.1999 15:10 Mod. MA100C Ser. no. 90805355 Ver. no. 01-38-07 ID ----- Prg 3 POWD.MILK SPRM Heating GENTLE Fin.temp. 100 C Time 5.0 min Stdbby temp. OFF Start W/STABIL. End SPRM IniWt + 4.492 g ----- </pre>
The current moisture loss is displayed afterwards		
The moisture analyzer heats the sample uniformly to 100 °C within 5 minutes		
Press STOP to end the analysis; the rate of weight loss is calculated and stored with the drying parameters.	soft key Stop	
The footer for the moisture analysis is printed		<pre> ----- Analys.Time 6.2 min FinWt + 4.328 g Res + 3.65 %L SPRM Difference 1.2 % Interval 24 sec ----- </pre>





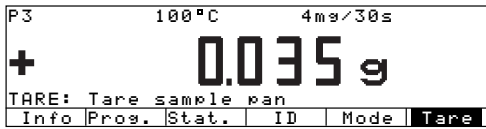
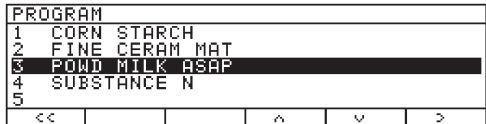
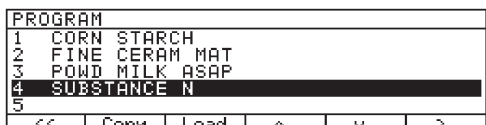
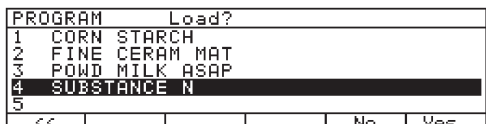
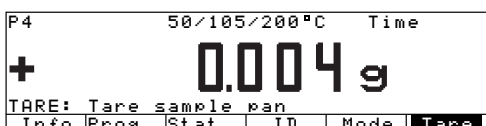

Example 4: Gentle Drying with Semi-automatic Shutoff Mode

The moisture content of 3.5 g of an unknown substance is to be determined. The sample to be analyzed is known to contain surface moisture and the moisture of two bound fractions. The three moisture contents are to be individually quantified by drying.

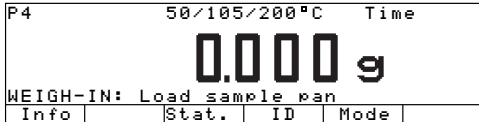

Settings (different from the factory settings):

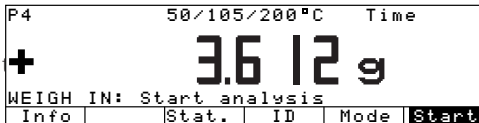

- Program number: 4
- Program name: substance N
- Heating program: phase drying
- Temperature 1: 50 °C
- Time 1: 4 minutes
- Temperature 2: 105 °C
- Time 2: 6 minutes
- Final temperature: 200 °C
- End of analysis: Time: 4 minutes
- Printout footer: Phase results (for input sequence see the chapter entitled “Configuring the Moisture Analyzer”)

Step	Key (or instruction)	Display/Printout
1. Turn on the moisture analyzer	 key	Sartorius logo is displayed Self-test runs
The above mentioned parameters for drying program 4 “Substance N” have already been set	Enter the parameters: see Example 1	
2. Select program display	Prog. soft key	
3. Select program “4”	v soft key	
4. Load the program “Substance N”	Load soft key	
5. Confirm load prompt	Yes soft key	

Step	Key (or instruction)	Display/Printout
6. Prepare the sample	see the section on "Preparing a Sample"	
7. Open the sample chamber Position a new sample pan	 key 	
8. Tare the sample pan	Tare soft key	
9. Apply approx. 3.5 g of to the sample pan Close the sample chamber	 	
10. Start the drying program	Start soft key	
# After 2 seconds' delay the header for moisture analysis is printed		<pre> ----- 14.07.1999 16:10 Mod. MA100C Ser. no. 90805355 Ver. no. 01-38-07 ID ----- Prg 4 SUBSTANCE N Heating PHASES Temp.1 50 'C Time1 4.0 min Temp.2 105 'C Time 2 6.0 min Fin.temp. 200 'C Stdbby temp. OFF Start W/STABIL. End TIME Time 4.0 min IniWt + 3.612 g ----- </pre>
The current moisture loss is displayed afterwards		

Step	Key (or instruction)	Display/Printout																																		
		The sample is preheated to 50 °C. After 4 minutes, the sample is heated to 105 °C.																																		
11. Display the analysis information (The moisture loss during phase 1 is displayed; in this case, 2.00 %L)	Info soft key	<table border="1"> <tr><td colspan="4">INFO</td></tr> <tr><td>1:</td><td>4.0min</td><td>Res1 +</td><td>2.00 %L</td></tr> <tr><td>2:</td><td>6.0min</td><td></td><td></td></tr> <tr><td>3:</td><td>4.0min</td><td></td><td></td></tr> <tr><td colspan="4">-----</td></tr> <tr><td><<</td><td></td><td></td><td></td></tr> </table>	INFO				1:	4.0min	Res1 +	2.00 %L	2:	6.0min			3:	4.0min			-----				<<													
INFO																																				
1:	4.0min	Res1 +	2.00 %L																																	
2:	6.0min																																			
3:	4.0min																																			

<<																																				
12. Exit ANALYS. INFO display After an additional 6 minutes, the sample is heated to 200 °C.	<< soft key	<table border="1"> <tr><td>P4</td><td>50/105/200°C</td><td>Time</td><td></td></tr> <tr><td>+</td><td></td><td>2.81 %L</td><td></td></tr> <tr><td colspan="4">ANALYSIS: 105°C 8.2min 20ms/24s</td></tr> <tr><td>Info</td><td></td><td>Mode</td><td>Cancel</td></tr> </table>	P4	50/105/200°C	Time		+		2.81 %L		ANALYSIS: 105°C 8.2min 20ms/24s				Info		Mode	Cancel																		
P4	50/105/200°C	Time																																		
+		2.81 %L																																		
ANALYSIS: 105°C 8.2min 20ms/24s																																				
Info		Mode	Cancel																																	
13. Display the analysis information (The moisture loss during phase 2 is displayed; in this case: 5.54 %L)	Info soft key	<table border="1"> <tr><td colspan="4">INFO</td></tr> <tr><td>1:</td><td>4.0min</td><td>Res1 +</td><td>2.00 %L</td></tr> <tr><td>2:</td><td>6.0min</td><td>Res2 +</td><td>5.54 %L</td></tr> <tr><td>3:</td><td>4.0min</td><td></td><td></td></tr> <tr><td colspan="4">-----</td></tr> <tr><td><<</td><td></td><td></td><td></td></tr> </table>	INFO				1:	4.0min	Res1 +	2.00 %L	2:	6.0min	Res2 +	5.54 %L	3:	4.0min			-----				<<													
INFO																																				
1:	4.0min	Res1 +	2.00 %L																																	
2:	6.0min	Res2 +	5.54 %L																																	
3:	4.0min																																			

<<																																				
14. Exit ANALYS. INFO display After the analysis time has elapsed, the footer for moisture analysis is printed.	<< soft key	<table border="1"> <tr><td>P4</td><td>50/105/200°C</td><td>Time</td><td></td></tr> <tr><td>+</td><td></td><td>9.78 %L</td><td></td></tr> <tr><td colspan="4">ANALYSIS: 200°C 2.2min 46ms/24s</td></tr> <tr><td>Info</td><td></td><td>Mode</td><td>Cancel</td></tr> </table> <table border="1"> <tr><td colspan="2">Analys.Time 14.0 min</td></tr> <tr><td>FinWt +</td><td>3.040 g</td></tr> <tr><td colspan="2">-----</td></tr> <tr><td>Res1 +</td><td>2.00 %L</td></tr> <tr><td>Res2 +</td><td>5.54 %L</td></tr> <tr><td>Res3 +</td><td>6.30 %L</td></tr> <tr><td colspan="2">-----</td></tr> <tr><td>Res +</td><td>13.84 %L</td></tr> <tr><td colspan="2">-----</td></tr> </table>	P4	50/105/200°C	Time		+		9.78 %L		ANALYSIS: 200°C 2.2min 46ms/24s				Info		Mode	Cancel	Analys.Time 14.0 min		FinWt +	3.040 g	-----		Res1 +	2.00 %L	Res2 +	5.54 %L	Res3 +	6.30 %L	-----		Res +	13.84 %L	-----	
P4	50/105/200°C	Time																																		
+		9.78 %L																																		
ANALYSIS: 200°C 2.2min 46ms/24s																																				
Info		Mode	Cancel																																	
Analys.Time 14.0 min																																				
FinWt +	3.040 g																																			

Res1 +	2.00 %L																																			
Res2 +	5.54 %L																																			
Res3 +	6.30 %L																																			

Res +	13.84 %L																																			

13. Display the analysis information after the analysis time has elapsed (The moisture loss of phases 1, 2 and 3 and the final result are displayed)	Info soft key	<table border="1"> <tr><td colspan="4">INFO</td></tr> <tr><td>1:</td><td>4.0min</td><td>Res1 +</td><td>2.00 %L</td></tr> <tr><td>2:</td><td>6.0min</td><td>Res2 +</td><td>5.54 %L</td></tr> <tr><td>3:</td><td>4.0min</td><td>Res3 +</td><td>6.30 %L</td></tr> <tr><td colspan="4">-----</td></tr> <tr><td></td><td>14.0min</td><td>Res +</td><td>13.84 %L</td></tr> <tr><td><<</td><td></td><td></td><td></td></tr> </table>	INFO				1:	4.0min	Res1 +	2.00 %L	2:	6.0min	Res2 +	5.54 %L	3:	4.0min	Res3 +	6.30 %L	-----					14.0min	Res +	13.84 %L	<<									
INFO																																				
1:	4.0min	Res1 +	2.00 %L																																	
2:	6.0min	Res2 +	5.54 %L																																	
3:	4.0min	Res3 +	6.30 %L																																	





	14.0min	Res +	13.84 %L																																	
<<																																				





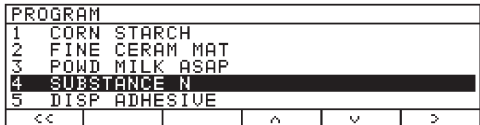

Example 5: Timer Shutoff Combined with Fully Automatic Shutoff Mode

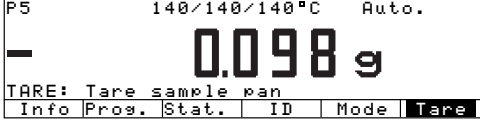
The moisture content of 1.5 g of dispersion adhesive is to be analyzed. While heating, the product forms a skin that makes it difficult for moisture to evaporate from the sample. Increased moisture loss causes this skin to crack, enabling the moisture to evaporate easily again from the sample. To prevent the moisture analyzer from shutting off too early during the initial phase, a minimum time for the drying procedure is entered. The analysis is to be ended automatically as soon as a constant weight is reached.

Settings (different from the factory settings):

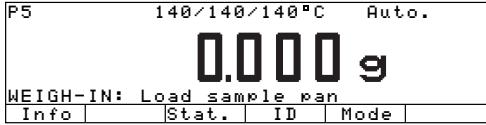
- Program number: 5
- Program name: dispersion adhesive (disp. adhesive)
- Heating program: phase drying
- Temperature 1: 140 °C
- Time 1: 5 minutes
- Temperature 2: 140 °C
- Time 2: 0 minutes
- Final temperature: 140 °C
- End of analysis: automatic (factory setting)
- Printout footer: Phase results (see also the chapter entitled “Configuring the Moisture Analyzer”)

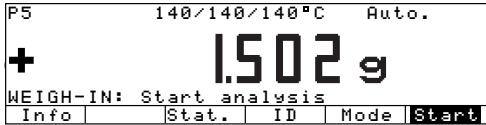
Step	Key (or instruction)	Display/Printout
1. Turn on the moisture analyzer	 key	Sartorius logo is displayed Self-test runs
The above-mentioned parameters for drying program 4 “Substance N” have already been set	Enter the parameters: see Example 1	
2. Select program display	Prog. soft key	
3. Select program “5”	▼ soft key	
4. Load the program “Disp adhesive”	Load soft key	
5. Confirm load prompt	Yes soft key	

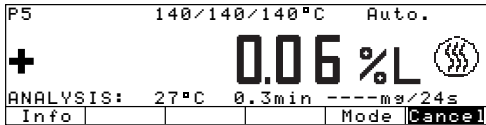
Step	Key (or instruction)	Display/Printout
6. Prepare the sample: not necessary for dispersion adhesive		
7. Open the sample chamber Position a new sample pan	 key 	
8. Tare the sample pan	Tare soft key	
9. Apply approx. 1.5 g of to the sample pan Close the sample chamber	  key	
10. Start the drying program	Start soft key	
After 2 seconds' delay the header for moisture analysis is printed		<pre> ----- 14.07.1999 17:10 Mod. MA100C Ser. no. 90805355 Ver. no. 01-38-07 ID ----- Prg 5 DISP ADHESIVE Heating PHASES Temp.1 140 'C Time1 5.0 min Temp.2 140 'C Time2 0.0 min Fin. temp. 140 'C Stdbby temp. OFF Start W/STABIL. End AUTOMATIC IniWt + 1.502 g ----- </pre>
The current moisture loss displayed afterwards		

Step

Key (or instruction)

Display/Printout

The sample is heated to 140 °C and dried for at least 5 minutes (phase 1).

```
P5          140/140/140°C   Auto.
+          25.74 %L
ANALYSIS: 140°C   5.0min 436mg/24s
Info      Mode  Cancel
```

If a constant weight has not been reached after 5 minutes, the drying process is continued until a constant weight is reached (in this case: after 9.5 minutes).

```
P5          140/140/140°C   Auto.
+          44.31 %L
ANALYS END: 136°C   9.5min
Info      Stat.  Mode  Next
```

After the constant weight has been reached, the footer for the moisture analyzer is printed.

```
Analys.time  9.5 min
FinWt +      0.836 g
-----
Res1 +       25.74 %L
Res2 +        0.00 %L
Res3 +       18.57 %L
-----
C-Res +      44.31 %L
-----
```

"isoTEST" Calibration/ Adjustment Functions

The following functions are available:

- TEST key
 - └ Weighing system settings
 - └ Ext. cal./adj.: factory-defined weight
 - └ Ext. cal./adj.: user-defined weight
 - └ Internal cal./adjustment
 - └ "reproTEST"
 - └ Weighing (only)
 - └ Hardware tests
 - └ Test interfaces
 - └ Heater test
 - └ Heater adjustment

If the sample pan and the pan support are removed from the sample chamber, you can access the following functions:

- TEST key
 - └ Heater adjustment
 - └ 2-point temperature adjustment
 - └ 1-point temperature adjustment

Heater Adjustment

Using 1-point and 2-point temperature adjustment and the YTM05MA temperature adjustment set (Accessories) you can calibrate and adjust temperature settings of the drying unit.

Weighing System Settings

Calibration, Adjustment

Purpose

Calibration is the determination of the difference between the weight readout and the true weight (mass) of a sample. Calibration does not entail making any changes within the weighing system.

Adjustment is the correction of the difference between the measured value displayed and the true weight (mass) of a sample, or the reduction of the difference to an allowable level within maximum permissible error limits.

Features

Calibration can be performed externally or internally.

- External calibration can be performed:
- with a factory-defined weight
 - with a user-defined weight

You can have calibration and adjustment results documented as a ISO/GLP-compliant printout; see the next page.

Selecting the Calibration/ Adjustment Mode

After pressing the TEST key and selecting the menu item **Weighing System Settings**

you can select one of the following modes:

- External calibration/adjustment with a factory-defined weight **Ext.cal./adj.; factory-def.wt**
- External calibration/adjustment with a user-defined weight **Ext.cal./adj.; user-def.wt**
- Internal calibration/adjustment **Int.cal./adj.**
- Repeatability test **reproTEST**
- Weighing only **Weighing**

Start the desired mode:

- Press the > soft key
- Press the Start soft key

External Calibration/Adjustment with a Factory-Defined Weight

Externally calibrate weighing system and adjust using factory-defined (standard) weight

Step	Key (or instruction)	Display/Printout
1. Select isoTEST function	TEST key	<pre>isoTEST Weighing system settings Hardware Tests << v >></pre>
2. Select "Weighing system settings"	> soft key	<pre>isoTEST WGH.SYS. Ext. cal./adj.: factory-def. wt. Ext. cal./adj.: user-defined wt. Internal cal./adjustment reproTEST Weighing << < v >></pre>
3. Select external calibration/adjustment with factory-defined weight (tare the weighing system, if necessary)	> soft key	<pre>0.000 g WGH.SYS: Ext. cal. factory-def. wt << Start Tare</pre>
4. Start external calibration	Start soft key	<pre>- 50.000 g WGH.SYS: Ext. cal. factory-def. wt</pre>
5. Place standard weight (e.g., 50 g) on the weighing system Minus sign -: weight too low Plus sign +: weight too high No plus/minus sign: weight o.k. This is displayed after calibration:	Load standard weight	<pre>50.000 WGH.SYS: Ext. cal. factory-def. wt</pre>
		<pre>+ 0.001 g WGH.SYS: Ext. adj. factory-def. wt End Start</pre>
6. If you do not need to adjust the weighing system	End soft key	<pre>----- 07.09.1999 13:03 Mod. MA100C Ser. no. 90805355 Ver. no. 01-38-07 ID ----- External calibration Nom. + 50.000 g Diff. + 0.001 g ----- 07.09.1999 13:03 Name: -----</pre>

Step	Key (or instruction)	Display/Printout
------	----------------------	------------------

Otherwise, adjust the weighing system
This is displayed after adjustment:

Start soft key



```

-----
07.09.1999      13:04
Mod.           MA100C
Ser. no.       90805355
Ver. no.       01-38-07
ID
-----
External calibration
W-ID
Nom. +        50.000 g
Diff. +        0.001 g
External adjustment
                completed
Diff.         0.000 g
-----
07.09.1999      13:04
Name:
-----

```

7. Unload the weighing system

External Calibration/Adjustment with a User-defined Weight

You can define a weight for calibration/adjustment. External calibration/adjustment must be performed with weights that are traceable to a national standard and that have error limits which are at least 1/3 of the required tolerance of the display accuracy. The defined weight must equal at least 10 % of the maximum weighing capacity.





See page 52 for the external calibration/adjustment sequence. For this example, select "Ext. cal./adj.; user-defined weight."

The moisture analyzer has a factory-set calibration weight value (see "Specifications"). Enter the factory-defined value manually:

- Select Setup menu: Press the **SETUP** key
- Select menu item
Device parameters
- Select menu item **Calibration/adjustment**
- Change **Cal./Adj. wt.**

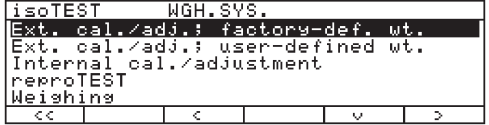
Internal Calibration/Adjustment

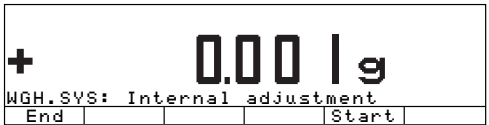
Inside the moisture analyzer is a built-in motorized calibration weight.

Step	Key (or instruction)	Display/Printout
1. Select isoTEST function	TEST key	 <pre> isoTEST Weighing system settings Hardware Tests << v >> </pre>
2. Select "Weighing system settings" function	> soft key	 <pre> isoTEST WGHSYS. Ext. cal./adj.: factory-def. wt. Ext. cal./adj.: user-defined wt. Internal cal./adjustment reproTEST Weighing << < v >> </pre>
3. Select "Internal calibration/adjustment"	v soft key twice > soft key	 <pre> + 0.001 g WGHSYS: Internal calibration << Start Tare </pre>
4. Start internal calibration sequence Internal calibration weight is applied automatically The weighing system is calibrated The internal calibration weight is removed from the weighing system This is displayed after calibration:	Start soft key	 <pre> + 0.001 g WGHSYS: Internal adjustment End Start </pre>
6. If you do not need to adjust the weighing system Otherwise, adjust the weighing system The weighing system is adjusted This is displayed after adjustment:	End soft key Start soft key	<p>Calibration printout is generated</p>  <pre> 0.000 g WGHSYS: Internal calibration << Start Tare </pre> <p>Adjustment printout is generated</p>

Repeatability Test “reproTEST”

Purpose





The “reproTEST” function automatically determines the repeatability of results (based on six individual measurements). In this way, the weighing system determines one of the most important quantities.

Definition

Repeatability is the ability of the weighing system in the moisture analyzer to display identical readouts when it is loaded several times with the same weight under constant ambient conditions.

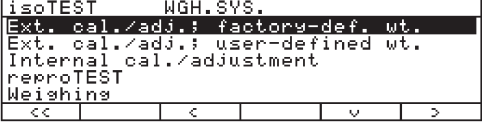
The standard deviation for a given number of measurements is used to quantify the repeatability.

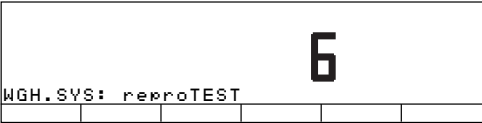
Testing the Weighing System Repeatability

Step	Key (or instruction)	Display/Printout
1. Select isoTEST function	TEST key	 <pre> isoTEST Weighing system settings Hardware Tests << v > </pre>
2. Select “Weighing system settings” function	> soft key	 <pre> isoTEST WGH.SYS. Ext. cal./adj.: factory-def. wt. Ext. cal./adj.: user-defined wt. Internal cal./adjustment reproTEST Weighing << < v > </pre>
3. Select “reproTEST” and confirm	v soft key three times > soft key	 <pre> + 0.001g WGH.SYS: reproTEST Start Tare </pre>
4. Start the repeatability test	Start soft key	
5. Number of measurements is displayed; 6 measurements will now be performed		 <pre> 6 WGH.SYS: reproTEST </pre>
The standard deviation is displayed		 <pre> 0.001g WGH.SYS: reproTEST End Start </pre>
6. End reproTEST or restart reproTEST	End soft key Start soft key	Report is printed.

Hardware Tests

Purpose

Hardware tests are performed to check whether the system communication with internal and external devices functions properly. These tests are not elementary hardware tests.

The following device elements can be tested:

- SBI communication
- Internal printer (optional)
- Digital I/O communications port
- Heater test
- Heater adjustment

Activating Hardware Tests

Step	Key (or instruction)	Display/Printout
1. Select isoTEST function	 key	<pre>isoTEST Weighing system settings Hardware Tests << v >></pre>
2. Select function hardware tests and confirm	⏏ soft key ⏏ soft key	<pre>isoTEST HARDWARE Test interfaces Heater test Heater adjustment << < v >></pre>

Testing SBI Communication

Step	Key (or instruction)	Display/Printout
1. Prepare the test connector for the RS-232 port (see "Pin Assignment Chart")	Connect Tx/D (pin 2) with Rx/D (pin 3)	
2. Select "Hardware tests"	see above	
3. Select "Test interfaces" function and confirm	⏏ soft key	<pre>isoTEST HARDWARE INTERFACE Test SBI communication Internal printer test Digital I/O test << < v >></pre>
4. Confirm "SBI communication test" function	⏏ soft key	<pre>HARDWARE Interface SBI Result: << >></pre>
At the end of the test, the result is displayed: Test error or: Test OK (in this case, Test error) (the test is repeated continuously)		<pre>HARDWARE Interface SBI Result: Test error << >></pre>
5. Exit "SBI communication test"	<< soft key	



Testing the Internal Printer (Option)

Step	Key (or instruction)	Display/Printout
1. Select "Hardware tests"	see above	
2. Select "Test interfaces" function and confirm	> soft key	<pre>isoTEST HARDWARE INTERFACE Test SBI communication Internal printer test Digital I/O test << < v ></pre>
3. Select "Internal printer test" function and confirm	⌵ soft key > soft key	<pre>HARDWARE Interface INT.PRINTER Result: << < ></pre>
If the test is passed:		All printable characters will be output on the internal printer
At the end of the test, the following result is displayed: Test error or: End of test (in this case: End of test)		<pre>HARDWARE INTERFACE INT.PRINTER Result: End of test << < ></pre>
4. Exit internal printer test	<< soft key	

Testing Digital I/O Ports

Step	Key (or instruction)	Display/Printout
1. Prepare the test connector for the RS-232 port (see "Pin Assignment Chart")	Connect universal key (pin 15) with digital I/O port (pin 16 ... pin 19) to be tested	
2. Select "Hardware tests"	see the previous page	
3. Select "Test interfaces" function and confirm	> soft key	<pre>isoTEST HARDWARE INTERFACE Test SBI communication Internal printer test Digital I/O test << < v ></pre>
4. Select "Digital I/O port test" function and confirm	⌵ soft key twice > soft key	<pre>HARDWARE Interface DIGITAL-I/O Result: << < ></pre>
"Test error" or "Test OK" is displayed for each I/O port. The test starts over again with the first port once the last port has been tested.		<pre>HARDWARE Interface DIGITAL-I/O Result: 1: Test error 2: Test ok 3: Test error 4: Test error << < ></pre>
5. Exit digital I/O port test	<< soft key	

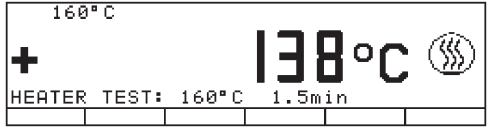
Testing the Heater

Step	Key (or instruction)	Display/Printout
1. Select "Hardware tests"	see the previous page	
2. Select "Heater test" and confirm	↵ soft key > soft key	
3. Start the heater test After initialization, the current temperature (in this case: 138 °C) and test time (in this case: 1.5 min) are displayed If the sample chamber is opened, the test stops until the sample chamber is closed again. After a brief time interval, the device reaches the nominal temperature.	Start soft key	 
4. Exit the heater test	Ⓞ soft key	

Heating Unit Adjustment

Purpose
After transporting or replacing the heating unit:
Determine the parameters that allow gentle opening and closing of the heating unit.

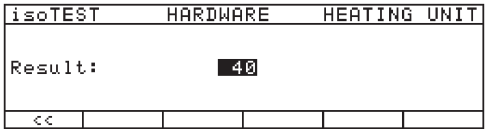
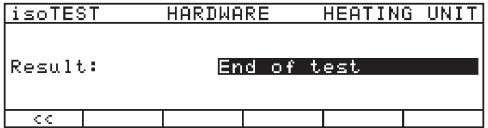
Step	Key (or instruction)	Display/Printout
1. Select "Hardware tests"	see the previous page	
2. Select "Heater adjustment" and confirm Open and close the sample chamber 20 times. When the test is concluded, the result is displayed: Either: Test Error or Test over	↵ soft key twice > soft key	 
3. Exit "Heater adjustment"	<< soft key	

Data Output

There are three options for data output:

- Output to the moisture analyzer
- Output to an internal printer (option)
- Output to a peripheral device (e.g., computer, external printer, PLC) via the interface port

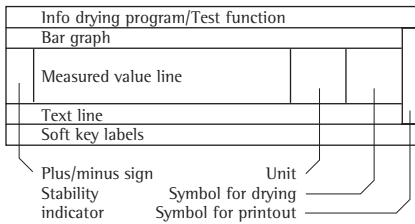

Output to the Moisture Analyzer (Weights and Calculated Values)

The display is divided into 9 sections. Information about the weighing system, the application being used and the sample weighed is output in the following sections:

- Drying program info
- Bar graph
- Plus/ minus sign, stability symbol display
- Line for moisture analysis values
- Weight unit display
- Drying symbol
- Application symbol display
- Text line

Drying Program Info

In this line, drying program data is displayed:

- P3 - Program number
- 80/105/120°C - Temperature data (for example: phase drying)
- 1.0%/60s - Shutoff parameter

Bar Graph (Overview Display)

In the bar graph, weighing results are displayed either

- 0% ██████████ 100% - as a percentage of the maximum weighing system capacity, or
- ██████████ ██████████ + - in relation to a target value, with the tolerance limits indicated.

The bar graph is displayed if either "Minimum and maximum initial weight" or "Target weight, tolerance in %" for initial weight is selected in the drying program.

Plus/ Minus Sign, Stability Symbol

This section shows:

- ⬢ - "Busy" symbol
- + - - Plus or minus sign

Line for Moisture Analysis Values

This line shows:

- 3.7482 - the current weight unit
- 7 - calculated values (e.g., % moisture)
- 35 - user-defined entries (e.g., preset tare)

Weight Unit Display

This section shows:

- g - the current weight unit (e.g., g)
- °C - the drying temperature unit
- %L - the unit for calculated values (e.g., % moisture)

Drying Symbol

This section shows:

-  - the symbol for active heating

Application Symbol

This column shows:

-  - the symbol for current print job

Text Line

This line contains:

- ANALYSIS: 78°C 1.3min - Explanatory text about the moisture analysis (e.g., temperature, time)
- TDK- - Explanation of error codes

Soft Key Labels

This line shows:

- Prog. Stat. ID Mode - Texts (abbreviations) to indicate the function assigned to each arrow key
- << < ^ v > ↓ - Symbol for selecting and confirming parameter settings (see also the chapter entitled "Operating Design")

Interface Description

Purpose

The moisture analyzer has an interface port for connection to an external printer or computer (or other peripheral device).

External Printer

You can use an external printer to generate printouts and document settings.

Computer

Analyses and calculated values can be transmitted to a computer for further evaluation and recording.

You can use a computer to monitor and remote-control the weighing system functions.

⚠ Warning When Using Pre-wired RS-232 Connecting Cables!

RS-232 cables purchased from other manufacturers often have incorrect pin assignments for use with Sartorius weighing systems! Be sure to check the pin assignments against the chart below before connecting the cable and disconnect any lines marked "Internally Connected" (e.g., pin 6). Failure to do so may damage or even completely ruin your weighing system and/or peripheral device.

Available Features

Type of interface:	Serial interface
Operating mode:	Full duplex
Standard:	RS-232
Transmission rates:	150; 300; 600; 1,200; 2,400; 4,800; 9,600; 19,200 baud
Number of data bits	7, 8 bit
Parity:	Space, odd, even
Number of stop bits:	1 or 2 stop bits
Handshake mode:	Software, hardware 1 character
Operating mode:	SBI, XBPI ¹⁾ , YDP011S ²⁾ , YDP011S-Label ²⁾ , Sartonet
Network address ³⁾ :	0, 1, 2, ..., 30, 31
Data output format of the weighing system:	22 characters + CR LF

¹⁾ XBPI operating mode: 9,600 baud, 8 bits, odd parity, 1 stop bit

²⁾ YDP011S and YDP011S-Label operating mode: 9,600 baud, 8 bits, odd parity, 1 start bit, 1 stop bit, software handshake

³⁾ Network address is only valid in the XBPI and Sartonet modes

Parameter Factory Settings for the Interface Port:

Transmission rate:	1,200 baud
Number of data bits	7 bits
Parity:	Odd
Stopbits:	1 stop bit
Handshake:	Hardware; 1 character
Operating mode:	SBI

Preparation

- See pages 66 and 67 for the pin assignment chart and cabling diagram.

Data Output Format

You can output the values, displayed in the corresponding line for moisture analysis values, and the weight unit with or without a data ID code.

Example: With data ID code
N + 3.4253 g

The number of characters output per line depends on the moisture analyzer model:

- for an (optional) internal printer: 24 characters per line
- YDP011SI Label: 22 characters per line
- SBI operating mode: 20 characters per line

The output format described below is only valid for outputs of standard measured values (SBI: 20 characters + CR LF). If more characters are output, 2 spaces will be entered between the ID code I and plus/minus sign.

ID code character I¹⁾

see page 21

Read Status: Active Application XXX²⁾

MAN	Moisture analysis
SET	Setup menu
TST	isoTEST menu
CBA	Cal./adj. wgh.sys.
CHT	Heater adjustment
CMS	Analysis adjustment
THW	Hardware test

Read Status:
 Sample Chamber Status zz²⁾

O	Sample chamber is completely opened
C	Sample chamber is completely closed
OC	Sample chamber is being closed now
CO	Sample chamber is being opened now
E	Undefined condition

Output Format with 20 Characters + CR LF

1	2	3	4	5	6	7	8	9	10	11	12	13	14	15	16	17	18	19	20	21	22	
I	I	I	I	I	I	+	*	D	D	D	D	D	D	D	*	U	U	U	CR	LF		
	*	*	*	*	*	-	*	*	*				
								X	X	X	y	y	z	z								
					*		*	*	*	*	*	*	*	*	*							
								0	0	0	0	0	0	0								

- I: ID code character¹⁾
- *: Space
- D: Digit or letter
- ¹⁾ depends on the MA model
- U: Unit symbol¹⁾
- CR: Carriage return
- LF: Line feed
- XXX xx zz: Response to the query Esc ars_ ("Read Status")²⁾

Error Codes

1	2	3	4	5	6	7	8	9	10	11	12	13	14	15	16	17	18	19	20	21	22
S	t	a	t	*	*	*	*	*	E	R	R	*	#	#	#	*	*	*	*	CR	LF

- *: Space
- ###: Error code number

Read Status: Application condition²⁾

	Operating mode	Action	Display
1	TARE	Tare the sample pan	Display analysis value
2	WEIGH-IN	Load the sample	Display analysis value
3	WEIGH-IN	Start analysis	Display analysis value
4	TARE/ANALYS. BEGIN	Waiting for stability	Blank
5	TARE	Waiting for taring to be completed	Blank
6	ANALYS. BEGIN	Close the sample chamber	Display analysis value
		Time delay begins	
7	ANALYSIS	Analysis in progress	Display mode
9	ANALYS. END/CANC'LD	End of analysis	Display mode
10	INFO	Info mode activated	Menu
11	MODE	Parameter mode activated	Menu
12	ID	ID input activated	Menu
13	STATISTICS	Statistics display activated	Menu
14	PROGRAM	Program memory activated	Menu
15	PAUSE	Wgh.sys error 50, 54, 53	ERR xxx

Data Input Format

You can connect a computer to your weighing system to send commands via the weighing system interface port to control functions and applications of the weighing system and the drying unit. SBI functions for remote control are only useful, if the current device/application mode can be read out any time.

The commands sent are control commands and may have different formats; e.g., control commands can have up to 26 characters. Each character must be transmitted according to the settings configured in the Setup menu for data transmission.

Format for Control Commands

Format 1:	Esc	!	CR	LF		
Format 2:	Esc	!	_	CR	LF	
Format 3:	Esc	!	#	_	CR	LF
Format 4:	Esc	!	#	max. 20 &t_	CR	LF

Esc:	Escape	_:	Underline (ASCII 95)
!:	Command character	CR:	Carriage RETURN (optional)
#:	1 or 2 digits	LF:	Line FEED (optional)
&t:	Digit or letter	max.	Depends on command character, i.e. parameter: once the max. length is attained, the input received cut off, rather than being rejected as with a keyboard input.





Format 1

!	Meaning
K	Weighing mode 1
L	Weighing mode 2
M	Weighing mode 3
N	Weighing mode 4
O	Block keys
P	Print
Q	Beep
R	Unblock keys
S	Restart

Format 2

!	Meaning
ars	Read status
acc	SBI commands only, no output to printer
acp	SBI commands with output to printer

Format 3

!#	Meaning
kF1	Soft key 1* Function depends on system state
kF6	Soft key 6*
kF7	Function key 
kF8	Function key 
kF9	Function key 
kF10	Function key 
kF11	Function key 
x1	Print weighing system model
x2	Print serial number
x3	Print weighing system software version
x4	Print operating software version
x5	Print (GLP) weighing system ID number
x6	Print weight set ("inventory") number

Format 4

!#	Meaning
t	Alphanumeric input (max. character number depends on display)
z5	Input (GLP) ID number (20 characters max.)
z6	Input weight set number (14 characters max.)

* numbered from right to left

Synchronization

During data communication between the moisture analyzer and an on-line device (computer), messages consisting of ASCII characters are transmitted via the interface. For error-free data communication, the parameters for baud rate, parity, handshake mode and character format must be the same for both units.

You can adapt your moisture analyzer by setting corresponding parameters in the Setup menu.

If you do not plug a peripheral device into the analyzer's interface port, this will not generate an error message.

Handshake

The moisture analyzer SBI interface (Sartorius Balance Interface) has transmit and receive buffers. You can define the handshake parameter in the Setup menu:

- Hardware handshake (CTS/DTR)
- Software handshake (XON, XOFF)

Hardware Handshake

With a hardware handshake, 1 more character can be transmitted after CTS (Clear to Send).

Software Handshake

The software handshake is controlled via XON and XOFF. When a device is switched on, XON must be transmitted to enable any connected device to communicate.

When the software handshake is configured in the Setup menu, the hardware handshake becomes active after the software handshake.

The data transmission sequence is as follows:

```
Moisture analyzer (transmitting device)  --- byte ----> Computer (receiving device)
--- byte ---->
--- byte ---->
<--- XOFF ---
--- byte ---->
--- byte ---->
...
(Pause)
...
<--- XON ---
--- byte ---->
--- byte ---->
--- byte ---->
--- byte ---->
```

Transmitting Device:

Once XOFF has been received, it prevents further transmission of characters. When XON is received, it re-enables the transmitting device to send data.

Receiving Device:

To prevent too many control commands from being received at one time, XON is not transmitted until the buffer is almost empty.

Activating Data Output

You can define the data output parameter so that output is activated either when a print command is received or automatically and synchronously with the analyzer display or at defined intervals (Program: Printout intermediate results: On: Print interval).

Data Output by Print Command

The print command can be transmitted by pressing  or by a software command (Esc P).

Digital Input/Output Ports

Monitoring, Remote Control

You can monitor and remote-control the moisture analyzer. For this purpose, you should know the operating state of the unit.

The following external devices can be used here:

- Status display with digital input ports
- Process logic controllers
- Computer with communications port

Via the communications port, the status of the moisture analyzer and therefore the operating state of analysis can be read out. The moisture analyzer is remote-controlled by the functions used to activate the key functions.

Functions for Remote Control (see also "Data Input Format" and "Data Output Format"):

Read out the moisture analyzer status: ESCars_

Block/unblock the keys on the moisture analyzer: ESCO / ESCR or on the moisture analyzer via Setup: Device

Activate key functions: ESCP, ESCKF1_ to ESCKF11_

The respective operating state of the moisture analyzer will be transmitted to the digital output ports according to the chart "Operating State of Analysis" (see below).

The moisture limits for the control function at the ANALYSIS END (in tolerance, < min., > max.) are to be entered under soft key **Mode:Limits for control function.**

Remote control via the universal remote control switch input (pin 15):

- Set the universal remote control switch function to "Function key F1" ("Setup: Device: Extra functions: Ext. switch")
- Block/unblock the keys on the moisture analyzer, if necessary ("Setup: Device: Keys: Block")
- For complete control and analysis using the F1 function key, set the analysis start mode to "Fully automatic, with (with-out) stability" (Prog.xx: Start analysis)

If a bar code scanner/additional keypad is set, remote control is no longer possible via the universal remote control switch input.

Operating State of Analysis

State	Pin 16	Pin 17	Pin 18	Pin 19	Description
No analysis in progress	0	0	0	0	No drying program (Mode e.g., Off, Standby, Setup, isoTEST, Prog., Err xxx)
TARE/ WEIGH-IN Menu display	0	0	0	1	Drying program before analysis runs, but no values displayed: Mode, Info, ID, Statistics
TARE pause	0	0	1	0	Waiting for Tare soft key
TARE Waiting for taring to be completed	0	0	1	1	Tare soft key pressed; waiting for stability
WEIGH-IN Place the sample	0	1	0	0	
WEIGH-IN start analysis	0	1	0	1	
ANALYSIS started	0	1	1	1	e.g., Start analysis, Mode, Info
ANALYSIS display	0	1	1	0	
ANALYSIS END (within tolerance)	1	0	0	0/1	Analysis value display/Mode, Info, Statistics
ANALYSIS END (< min.)	1	0	1	0/1	Analysis value display/Mode, Info, Statistics
ANALYSIS END (> max.)	1	1	0	0/1	Analysis value display/Mode, Info, Statistics
ANALYSIS CANCEL	1	1	1	0/1	Analysis value display/Mode, Info, Statistics

Pin Assignment Chart

Female Interface Connector:

25-position D-Submini, DB25S, with screw lock hardware for cable gland

Male Connector Used: (please use connectors with the same specifications):

25-pin D-Submini, DB25S, with integrated shielded cable clamp assembly (Amp type 826 985-1C) and fastening screws (Amp type 164 868-1)

Pin Assignment Chart:

- Pin 1: Signal Ground
- Pin 2: Data Output(TxD)
- Pin 3: Data Input(RxD)
- Pin 4: Signal Return(TxD/RxD)
- Pin 5: Clear to Send (CTS)
- Pin 6: Internally Connected
- Pin 7: Internal Ground
- Pin 8: Internal Ground
- Pin 9: Reset _ In**)
- Pin 10: - 12 V
- Pin 11: + 12 V
- Pin 12: Reset _ Out**)
- Pin 13: + 5 V
- Pin 14: Internal Ground
- Pin 15: Universal Key/Keypad Data*
- Pin 16: Digital I/O 1*
- Pin 17: Digital I/O 2*
- Pin 18: Digital I/O 3*
- Pin 19: Digital I/O 4*/Clock Rate for Keypad
- Pin 20: Data Terminal Ready (DTR)
- Pin 21: Supply Voltage Ground "COM"
- Pin 22: Not Connected
- Pin 23: Not Connected
- Pin 24: Supply Voltage Input + 15 ... 25 V
- Pin 25: +5 V

*) = See Universal Key in the chapter entitled "Configuring the Moisture Analyzer" for information on changing pin assignments, as well as "Data Output: Digital Input/Output Ports".

***) = Hardware restart

Cabling Diagram

- Diagram for interfacing a computer or different peripheral device to the moisture analyzer using the RS-232C/V24 standard and cables up to 15 m (50 ft.) long

Weighing System

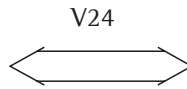
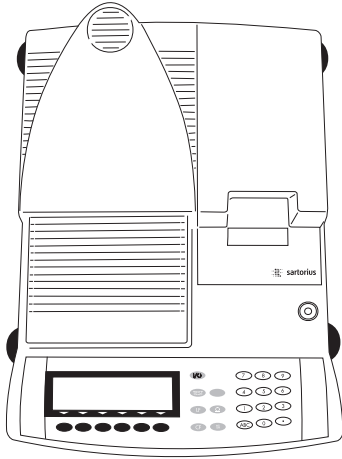

Peripheral Device

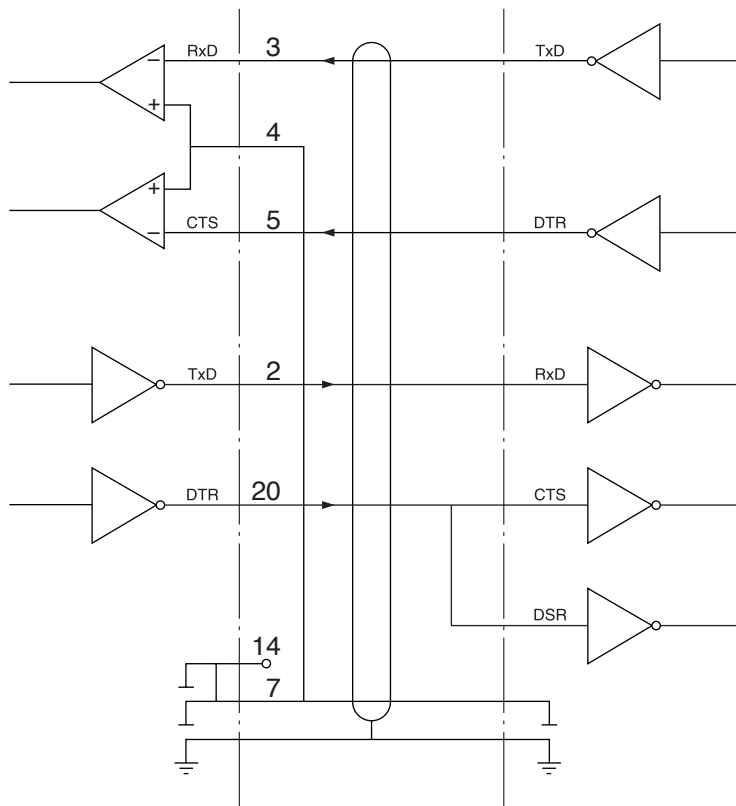

25-pin	PC or	9-pin
2		3
20		4
3		2
5		8
6		6
7		5

Type of cable: AWG 24 specification

Error Codes

Error Codes

Error codes are displayed in the main display or text line for 2 seconds.
The program then returns automatically to the previous status.

Display	Cause	Solution
No segments appear on the display	No AC power is available The power cord is not plugged in Fuses are defective	Check the AC power supply Plug in the power cord Replace the fuses
H	The load exceeds the weighing capacity	Unload the pan support
L or Err 54	The pan support is not in place	Place the pan support on the weighing system
Err 01 > Display range	Data output not compatible with output format	Change the configuration in the Setup menu
Err 02 Cal. n. possible	Calibration/adjustment condition not met, e.g., – not tared – the pan support is loaded	Calibrate only when zero is displayed Press the Tare soft key to tare Unload the moisture analyzer
Err 03 Cal./adj. interrupt	Calibration/adjustment could not be completed within a certain time	Allow the moisture analyzer to warm up again and repeat the adjustment process
Err 06 defective	Built-in calibration weight in MA100 is defective	Contact your local Sartorius Int. wt. Service Center
Err 11 Tare2 blocked	Tare memory not allowed (Tare value exceeds the weighing range)	Check the tare value entered Unload the moisture analyzer and tare
Err 30 Print fct. blocked	Interface port for printer output is blocked	Contact your local Sartorius Service Center to have the port configured for printer output
Err 31 Print fct. blocked	External device not ready to send (interface handshake interrupted) XOFF, CTS)	Transmit XON, then CTS
Err 101, 102, 103 or 104 “Checkerboard” pattern displayed continuously	Key is stuck Key pressed when switching on the moisture analyzer Ⓢ key was pressed when turning on the moisture analyzer, or is stuck	Release key or contact your local Sartorius Service Center
Err 320	Operating program memory is wrong	Contact your local Sartorius Service Center
Err 340	Operating parameter (EEPROM) is wrong	Contact your local Sartorius Service Center
Err 341	The built-in battery for drying programs is drained	Leave the analyzer connected to AC power for at least 10 hours
Err 342	Operating parameter (EEPROM) is wrong except for adjustment parameters	Contact your local Sartorius Service Center
No WP	Weighing system is defective	Contact your local Sartorius Service Center

Display	Cause	Solution
Too many characters	Input text too long	Allowable text lengths, incl. decimal point: – Password: 8 characters max. – User ID: 20 characters max. – Wt ID: 14 characters max.
No num. value xxxxx too low xxxxx too high	Input wrong (with any application program), e.g., alphabetic input not allowed	Follow the instructions for the application programs
Not found !	Input wrong (e.g., no program with entered name available)	Enter correct name or program number
blocked	Function blocked	None
Built-in printer (option):	No printout	Activate printer in Setup menu; install ink ribbon and paper correctly
Problem ... :	<p>Too high of a temperature is selected and the sample is oxidized;</p> <p>Sample boils or scorches and splashes continuously change weight</p> <p>Analysis time is too long</p> <p>Sample loses weight before it is analyzed</p> <p>Sample is liquid or pasty</p> <p>Sample contains too little moisture</p> <p>Insufficient heat output</p> <p>Place of installation exposed to interfering factors (vibration, etc.)</p>	<p>– Reduce the temperature – Put a glass fiber filter on top of the sample – Reduce the sample quantity or apply the sample more evenly – Select a semi-autom. shutoff parameter or select timer mode – Phase drying with decreasing temperature</p> <p>– Increase the temperature – Reduce the sample quantity – Preheat the unit by running it for 2 or 3 minutes with an empty sample pan</p> <p>– Remove the sample pan and apply the sample outside the sample chamber</p> <p>– Use a glass fiber filter</p> <p>– Increase the sample quantity</p> <p>– Clean the protective glass or temperature sensor</p> <p>– Change the place of installation</p>

If any other errors occur, please contact your local Sartorius Service Center.

Care and Maintenance

⚠ Warning

Disconnect supply before servicing!

Service

Regular servicing by a Sartorius technician will extend the service life of your moisture analyzer and ensure its continued weighing accuracy. Sartorius can offer you service contracts, with your choice of regular maintenance intervals ranging from 1 month to 2 years.

The frequency of the maintenance intervals depends on operating conditions and user tolerance requirements.

Repairs

Repair work must be performed by trained service technicians. Any attempt by untrained persons to perform repairs may lead to hazards for the user.

Cleaning

⚠ Make sure that no dust or liquid enters the moisture analyzer housing

⚠ Do not use any aggressive cleaning agents (solvents, abrasive cleaning agents, etc.); clean the moisture analyzer using a piece of cloth which has been wet with a mild detergent (soap) only

- Unplug the power cord from the wall outlet (mains supply)
If you have a cable connected to the interface port, unplug it from the moisture analyzer

- The base plate of the sample chamber, the shield disk and the pan support can be removed for cleaning

- Carefully remove any sample residue / spilled powder by using a brush or a hand-held vacuum cleaner

- After cleaning, wipe down the analyzer with a soft, dry cloth

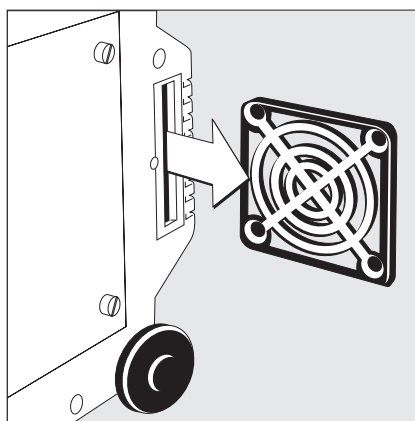
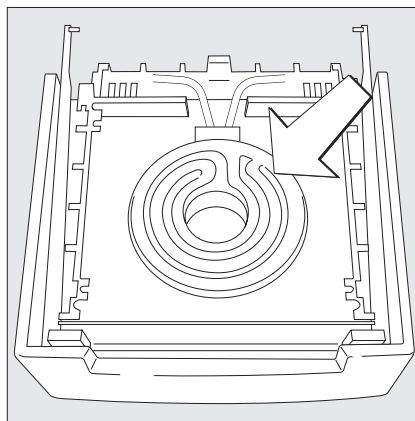
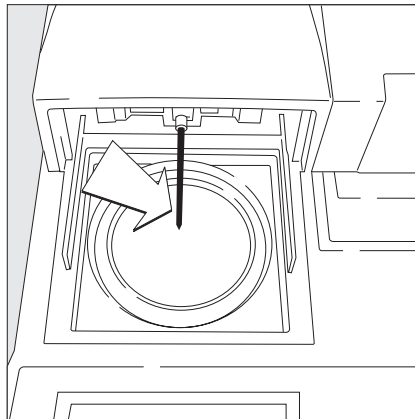
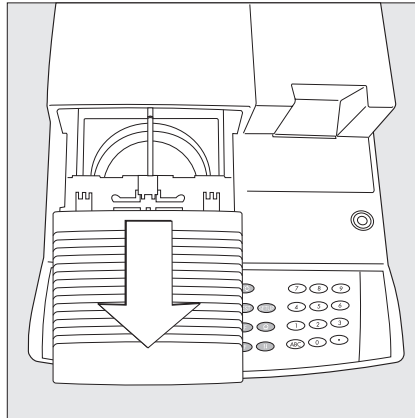

Cleaning the Heating Unit and Temperature Sensor

⚠ **Danger:** The terminals of the heating unit are under live current

- **To disconnect from AC power, unplug the power cord from the wall outlet (mains)**

If you have a cable connected to the interface port, disconnect it from the moisture analyzer

- Slide out the heating unit to remove

- Carefully remove any residue from the temperature sensor

- Place the disassembled heating unit on an even surface and use a commercially available cleaning agent for glassware to clean the ceramic heating element or the protective glass of the halogen lamp

Replacing the Fan Air Filter

- Remove any dust from the fan air inlet-located on the bottom of the moisture analyzer

- Check the air filter periodically and replace it if necessary (see Accessories)

- Place the moisture analyzer on its left side

- Unscrew the cover plate

- Pull out the air filter holder

- Open the air filter holder and remove the air filter

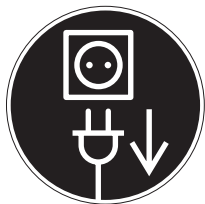

Replacing the Fuses

If no segments appear on the display after turning on the moisture analyzer, the fuses may be defective.

⚠ Warning
Unplug the moisture analyzer from AC power before replacing the fuses

⚠ Warning
For continued protection against risk of fire, replace only with same type and rating of fuses.

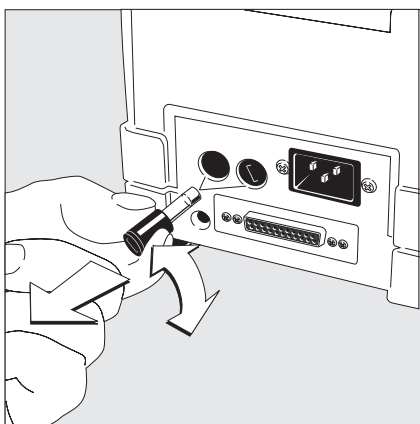

- Unscrew both fuse holders on the rear side of the moisture analyzer using the Allen wrench
- Check both fuses
- Replace the defective fuses:
T 6.3 A, 250 V, 5 x 20 mm
- If the moisture analyzer still does not function, please contact your local Sartorius Service Center.

⚠ Do not use other fuses or bypass the fuses.

Disassembling or Replacing the Heating Unit

A defective heating unit can be completely replaced. Also disassemble the heating unit before cleaning.

The following replacement work may only be performed by Sartorius service technicians (temperature adjustment required):

- To interchange the ceramic, coiled quartz, or halogen heating unit
- To interchange heating units with a voltage rating of 230 volts or 115 volts

⚠ Danger: The terminals of the heating unit are under live current

● **Before disassembling the heating unit, make absolutely sure to disconnect the moisture analyzer from AC power (mains) and allow the heating unit cool down for 10 minutes before removing it**

- Slide out the heating unit to remove
- Install the new or cleaned heating unit in the moisture analyzer

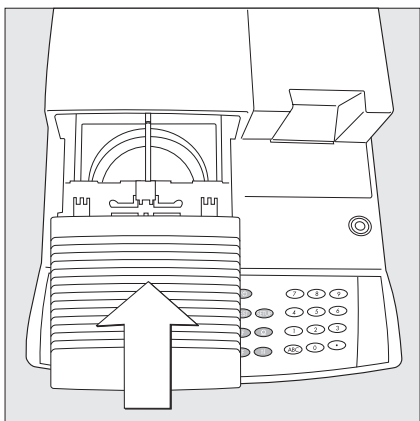

Safety Inspection

If there is any indication that safe operation of the moisture analyzer is no longer warranted:

- Turn off the power and disconnect the equipment from the wall outlet immediately
- > Lock the equipment in a secure place to ensure that it cannot be used for the time being

Safe operation of the moisture analyzer is no longer ensured when:

- there is visible damage to the moisture analyzer or power cable
- the moisture analyzer no longer functions properly
- the moisture analyzer has been stored for a relatively long period under unfavorable conditions
- the moisture analyzer has been exposed to rough handling during shipment

In this case, notify your nearest Sartorius Service Center. Maintenance and repair work may only be performed by service technicians who are authorized by Sartorius and who:

- have access to the required maintenance manuals
- have attended the relevant service training courses

We recommend that the moisture analyzer be inspected according to the following checklist by a qualified Sartorius service technician:

- Resistance of the protective grounding conductor: < 0.2 ohm measured with a commercially available multimeter
- Insulation resistance: > 2 megohms measured with a constant voltage of at least 500 volts at a 500 kohm load

The duration and number of measurements should be determined by a qualified Sartorius service technician according to the particular ambient and operating conditions. However, such inspection must be performed at least once a year.

Overview

Specifications for Models MA100

Model	MA100Q-.....	MA100C-....., MA100H-.....
Dryer functions:		
Heating element	Coiled quartz heating element	Ceramic IR heater, round halogen lamp
Temperature range	30 – 230 °C	30 °C – 180 °C
Temperature increments	adjustable in 1 °C increments	
Temperature adjustment	with YTM05MA temperature adjustment set	
Weighing functions:		
Weighing capacity	100 g	
Readability	1 mg/0.1 mg, 0.01 %/0.001 % moisture content	
Repeatability, average (%)	sample weight =1 g: 0.1 %, sample weight =5 g: 0.02 %	
External calibration weight (of at least accuracy class...)	50 g (E2)	
Sample pan dimensions	Ø 90 mm	
Drying parameters:		
Drying programs	standard, quick, gentle, 3 temperature phases	
Drying time	6 sec. to 999 min.	
Number of programs	30	
Shutoff criteria	Fully automatic, semi-autom., SPRM, time (3x 999 min.), manual	
Display for analysis results	Moisture (calculated value), dry weight, RATIO, weight loss, residual weight (g or g/kg)	
Analyzer (hardware):		
Dimensions (L x W x H)	350 x 453 x 156 mm	
Net weight, approx.	8 kg	
Voltage (AC)	100 V–120 V for MA100.-000115V1 200 V–240 V for MA100.-000230V1 selectable by replacing the heating unit, -10 % ... + 10 %	
Frequency	50/60 Hz	
Fuses	2 (neutral conductor/phase), 6.3 AT, 5 x 20 mm	
Operating temperature range	+10 ... +30 °C (50 °F – 86 °F)	
Power consumption	650 VA for Ceramic Heater; 400 VA for Halogen Heater; 650 VA for Quartz Heater max.	
Built-in interface	RS-232C	
Format:	7 or 8 bit ASCII, 1 start bit, 1 or 2 stop bits	
Parity:	Space, odd or even	
Transmission rates:	150 to 19,200 baud	
Handshake:	Software or hardware	
Digital input:	1, adjustable function	
Digital outputs:	4, operating state of analysis	
Equipment Ratings (Environmental Conditions):	<ul style="list-style-type: none"> – Pollution degree 2; – Installation category II; – Altitude 2000 m; – Humidity 80 % to temperatures up to 31 °C decreasing linearly to 50 % rH at 40 °C; max 80 % rh, non-condensing. – Indoor use statement; – IPX0 (provided all external cables are connected) 	
Interference resistance	Suitable for use in industrial areas	
Interference emission	Class B: Suitable for use in residential areas and areas that are connected to a low voltage network that also supplies residential buildings.	

Accessories (Options)

Product	Order No.
Integratable printer	YDP01MA
Printer expendables:	
– 5 paper rolls	69 06937
– ink ribbon	69 06918
Temperature adjustment set	YTM03MA
Exchangeable panels for drying unit (aluminum)	YDS05MA
Software for recording moisture analysis values	YMW02MA
Expendables:	
– 80 disposable sample pans, Ø 90 mm (aluminum)	69 65542
– 80 glass fiber filters (for liquid samples)	69 06940
Interface cable (RS-232/25-pin)	69 57312
RS-485 data interface	Information on request
Calibration weight, 50 g (E2) for all moisture analyzers; comprehensive assortment, available with certification	YCW4528-00
Standard Operating Procedure (SOP) For Working with a Moisture Analyzer (For Documentation for Quality Assurance)	YSL02A
Spare Parts	
Dust cover for keypad	6960MA01
Replacement filter for fan, complete	69MA0094
Forceps	69MA0072
Heating unit (can be exchanged by Sartorius service technicians only):	
Ceramic IR heating element, 230 volts	69MA0095
Ceramic IR heating element, 115 volts	69MA0096
Round halogen lamp, 230 volts	69MA0097
Round halogen lamp, 115 volts	69MA0098

Other spare parts can be ordered directly through your local Sartorius Service.

Declarations of Conformity



Original

EG-/EU-Konformitätserklärung EC / EU Declaration of Conformity



sartorius

Hersteller
Manufacturer Sartorius Lab Instruments GmbH & Co. KG
37070 Goettingen, Germany

erklärt in alleiniger Verantwortung, dass das Betriebsmittel
declares under sole responsibility that the equipment

Geräteart
Device type Feuchtebestimmer
Moisture Analyzer

Baureihe
Type series MA100C-000230V1, MA100H-000230V1, MA100Q-000230V1
MA100C-000115V1, MA100H-000115V1, MA100Q-000115V1

in der von uns in Verkehr gebrachten Ausführung allen einschlägigen Bestimmungen der folgenden Europäischen Richtlinien - einschließlich deren zum Zeitpunkt der Erklärung geltenden Änderungen - entspricht und die anwendbaren Anforderungen folgender harmonisierter Europäischer Normen - einschließlich deren zum Zeitpunkt der Erklärung geltenden Änderungen - erfüllt:

in the form as delivered fulfils all the relevant provisions of the following European Directives - including any amendments valid at the time this declaration was signed - and meets the applicable requirements of the harmonized European Standards including any amendments valid at the time this declaration was signed - listed below:

2014/30/EU	Elektromagnetische Verträglichkeit <i>Electromagnetic compatibility</i> EN 61326-1:2013
2011/65/EU	Beschränkung der Verwendung bestimmter gefährlicher Stoffe in Elektro- und Elektronikgeräten (RoHS) <i>Restriction of the use of certain hazardous substances in electrical and electronic equipment (RoHS)</i> EN 50581:2012
2006/42/EG 2006/42/EC	Maschinen <i>Machines</i> EN ISO 12100:2010, EN 61010-1:2010*, EN 61010-2-010:2015

Die Person, die bevollmächtigt ist, die technischen Unterlagen zusammenzustellen:
The person authorised to compile the technical file: Sartorius Lab Instruments GmbH & Co. KG
Electronics & Product Compliance
37070 Goettingen, Germany

Jahreszahl der CE-Kennzeichenvergabe | *Year of the CE mark assignment:* 18

Sartorius Lab Instruments GmbH & Co. KG
Goettingen, 2018-12-10

Dr. Reinhard Baumfalk
Head of Product Development
Lab Products and Services Division

Dr. Dieter Klausgrete
Senior Scientist Certification Management

*: angewandte, jedoch für Maschinen nicht harmonisierte Norm /
applied standard, which however is not harmonized for machines

Doc: 2406316-01 SLI18CE003-01.de,en 1 / 1 PMF: 2406315 OP-113_fo1_2015.10.12

FCC Supplier's Declaration of Conformity



Device type Moisture Analyzer

Type series MA100C-000115V, MA100H-000115V1, MA100Q-000115V1

Party issuing Supplier's Declaration of Conformity / Responsible Party – U.S. Contact Information

Sartorius Corporation
5 Orville Dr Suite 200
11716 Bohemia, NY
USA
Telephone: +1.631.254.4249

FCC Compliance Statement

This device complies with Part 15 of the FCC Rules. Operation is subject to the following two conditions: (1) This device may not cause harmful interference, and (2) this device must accept any interference received, including interference that may cause undesired operation.

Information to the user

Note: This equipment has been tested and found to comply with the limits for a **class B** digital device, pursuant to part 15 of the FCC Rules. These limits are designed to provide reasonable protection against harmful interference in a residential installation. This equipment generates, uses and can radiate radio frequency energy and if not installed and used in accordance with the instructions, may cause harmful interference to radio communications. However, there is no guarantee that interference will not occur in a particular installation. If this equipment does cause harmful interference to radio or television reception, which can be determined by turning the equipment off and on, the user is encouraged to try to correct the interference by one or more of the following measures:

- Reorient or relocate the receiving antenna.
- Increase the separation between the equipment and receiver.
- Connect the equipment into an outlet on a circuit different from that to which the receiver is connected.
- Consult the dealer or an experienced radio/TV technician for help.

Connections between the device and peripherals must be made using shielded cables in order to maintain compliance with FCC radio frequency emission limits.

Any modifications made to this device that are not approved by Sartorius may void the authority granted to the user by the FCC to operate this equipment.

Index

	Page		Page		Page
Accessories	73	Identification codes (ID)	31, 33, 35	Shutoff mode	30, 32
Acoustic signal	19	Information on using the moisture analyzer	2	Shutoff parameters	30, 32
Adjustment to the available measuring system	27	Installation instructions	5	Soft keys	10, 34
Adjustment	51	Intended use	2	Software handshake	18, 64
Analysis number	31, 33	Interface	18, 61	Specifications	72
Analysis with former sample	31, 33	Intermediate results printout	31	SPRM mode	27, 30, 33
Analysis, starting an	30, 32	Internal adjustment	54	Standard drying	32
Bar code scanner	19	Internal calibration	54	Standby temperature	30, 32
Basic function“ Weighing ”	51	isoTEST	51	Statistics	35, 36
Basics	25	Key labels	9	Storage and shipping conditions	5
Block keys	19	Keys	9	Synchronization	64
Brief instructions	8	Letters, entering	9	Test, heater	58
Cabling diagram	67	Level indicator	8	Test, interfaces	56, 57
Calibration	51	Leveling the moisture analyzer	8	Testing the heater	58
Care	70	Line format	62	Text input	9
Cleaning	70	Maintenance	70	Turning on the moisture analyzer	8
Configuring the moisture analyzer	13	Mode	35, 36	Universal remote control switch (function)	19
Configuring the printout	20	Numeric input	9	Unpacking the moisture analyzer	5
Connecting to AC power	7	Operating design	9	User ID	14, 18
Contents	3	Operating the moisture analyzer	25	Voltage	7
Data input format	63	Options	73	Warming up	7
Data interface	61	Password	15	Warning and safety information	4
Data output format	62	Password, entering/changing	15	Warranty	5
Data output	59	Phase drying information	35, 36	Weighing set number	18
Decimal points	31	Phase drying	32	Weighing system adjustment	51
Declarations of conformity	74	Pin assignment chart	66	Weighing-in,	30, 32
Device information	24	Pin assignment	66	Weight resolution for analysis	31, 33
Digital input/output ports	65	Practical examples	37		
Disassembling or replacing the heating unit	71	Preparing a sample	28		
Display background	19	Printer, integratable (option)	19, 738		
Display contrast	14, 19	Printout design	20		
Display mode	31, 33	Printout	20		
Display	10	Program name	30		
Drying parameters	30	Programs	32		
Drying programs	32	Quick drying	32		
Drying temperature	30	Recycling	5		
End of analysis	30, 32	Repairs	70		
Entering the general password	Appendix	Repeatability test	55		
Equipment supplied	5	reproTEST	55		
Error codes	68	Replacing the air filter	70		
Examples	37	Replacing the fuses	71		
External adjustment	52	Safety information	4		
External calibration	52	Safety inspection	71		
Factory setting	18, 31	Safety precautions	7		
Function keys (soft keys)	10, 34	Sample chamber, opening and closing	8		
General view (overview)	6	Sample crust	29		
Gentle drying	32	Searching for programs	33		
Getting started	5	Selecting the calibration/adjustment mode	51		
Handshake	18, 64	Service	70		
Hardware test	56	Setting device parameters	14		
Heater adjustment	51	Setting the language	13		
Heating program	30, 32	Setting the time and date	17		
Heating unit adjustment	58				

Entering the General Password

Enter/Change Password

- Select the Setup menu:
Press the **SETUP** soft key
- > SETUP is displayed
- Select the parameter:
Press the **↵** and **↩** soft keys
- > The password prompt is displayed:

SETUP	PASSW. CHECK
Enter password:	██████████
<<	<

- Enter the General Password
(see below)
- Confirm the password:
Press the **↵** soft key
- > Parameters are displayed

- Select password setting:
Press the **↵** or **↩** soft keys repeatedly and **↩**, until
- > Password is displayed, together with the current password setting
- Define a new password:
Enter letters/numbers for the new password
To delete the current password:
Press the **⊙** key and store
- To confirm your entry:
Press the **↵** soft key
- Exit the Setup menu:
Press the **↵** soft key
- > Restart your application

General Password:
40414243

Sartorius Lab Instruments GmbH & Co. KG
Otto-Brenner-Strasse 20
37079 Goettingen, Germany

Phone: +49.551.308.0
www.sartorius.com

The information and figures contained in these instructions correspond to the version date specified below.

Sartorius reserves the right to make changes to the technology, features, specifications and design of the equipment without notice.

Masculine or feminine forms are used to facilitate legibility in these instructions and always simultaneously denote the other gender as well.

Copyright notice:

This instruction manual, including all of its components, is protected by copyright.

Any use beyond the limits of the copyright law is not permitted without our approval.

This applies in particular to reprinting, translation and editing irrespective of the type of media used.

© Sartorius Germany

Last updated:
11 | 2018